

Alexandria Commission for the Arts

Regular Meeting

Tuesday, October 16th, 2018

Lee Center --- 7:00pm

MEETING NOTES

For the Attendance Sign-In Sheet for commissioners, City staff and guests in attendance, see [Attachment 1](#).

- I. Call to Order (7:09pm) – For the meeting agenda, see [Attachment 2](#).
- II. Presentation – Joan Singer, Founder and Music Director of QuinTango, gave an overview of the quintet’s local and international public outreach programs.
- III. Public Comment – Pat Kramer from the Symphony Orchestra of Northern Virginia announced the start of their season on October 28 and invited all to attend. Greg Knott, president of the Torpedo Factory Artists Association, introduced himself.
- IV. Approval of Minutes
 1. Tamsin Green reviewed edits to the draft minutes of the September 18th Regular Meeting. The minutes were approved with edits by unanimous consent.
- V. Chair Report – Matthew Stensrud gave his Chair Report, see [Attachment 3](#). Highlights included:
 1. Welcoming Caroline Schreiber, the Commission's newest member.
 2. Reviewing the Voting Stickers Poll.
 3. Encouraging Commissioners to attend RPCA workshops on funding.
- VI. Grants Committee
 1. FY2019 Grants
 - Allison Nance and Diane Ruggiero reviewed the staff’s draft proposal and the Grant Committee’s edits for use of remaining funds from FY2019 grants, see [Attachments 4 and 5](#).
 - Diane Ruggiero responded to questions, including:
 - Clarifying that for the Creative Partnership grants the applicant is the business or non-profit, and that the 2:1 cash match means the \$2500 grant must be matched by \$5000 for a total minimum project cost of \$7500.
 - Clarifying that the City has loosened the signage ordinance and Staff would work with applicants to make sure that projects abide by the signage ordinance if applicable. Projects will not be restricted to murals.
 - Addressing concerns over the application. The goal is to make the application as simple as possible and the final project design is not required as part of the initial application. Allison Nance also shared the suggested four question application.

- Addressing concerns over publicizing the Creative Partnership grants. Staff feels that there are many partners and business associations that they can reach out to.
- Additional discussion on the FY19 grants proposal included a desire to clarify the language about religious/political references so as not to be overly restrictive.
- A motion was made by Kadhambari Sridhar and seconded by Chris Kurowski to approve the FY2019 Art Grants Remaining Funds Memo as edited by the Grants Committee, with any discrepancies to be finalized by staff and the Grants Committee. The motion passed 15-0-0, see [Attachment 6](#).

2. FY2020 Grants

- Diane Ruggiero gave a presentation on the Office of the Arts' proposed modifications for the City's FY2020 Grant program, see [Attachment 7](#).
- Commissioners weighed the pros and cons of the proposed modifications.
- The Commission discussed the eligibility requirements for Emerging Organizations. Staff and the Grants committee heard concerns about defining an organization's "start" date and not wanting the requirements to be overly restrictive and will work to clarify language in this area.
- The Commission also discussed the process of renewing the second year of the grant, the possibility of a third renewal year, and whether organizations could apply for both an Emerging Organization grant and a Program grant. Staff and the Grants committee will take Commission feedback into consideration as they finalize the language for the FY20 Grants.
- A motion was made by Chris Kurowski and seconded by Shirley Downs to hold a public hearing at the Wednesday, November 14 ACA Regular Meeting to discuss the Office of the Arts proposed Fiscal Year 2020 Arts Grants Program. The motion passed 14-0-0, see [Attachment 8](#).

VII. Office of the Arts Division Update, see [Attachment 9](#).

1. Torpedo Factory Community Engagement Task Force

- Diane Ruggiero, Catherine Barrett and Beth Coast reviewed the consultants' final report, [see Attachment 10](#).
- Commissioners shared their takeaways from the report and their concerns regarding the overall process. Common themes included the desire for an Executive Summary, concern over the quality of the final report, and questions about the Commission's involvement and next steps. Diane Ruggiero let the Commission know that at that time, Staff had not received any direction from the City Manager as to next steps.
- Allison Nance suggested this might warrant another letter to the City Manager and City Council. Catherine Barrett and Beth Coast agreed to draft a letter to the City Manager regarding management of the process and ACA involvement in decision making. This would not come from the Commission as a body, but from individual commissioners.

2. King Street Waterfront Park Task Force

- Diane Ruggiero gave a presentation on the SOFTlab temporary public art proposal for King Street Waterfront Park, see [Attachment 11 and 12](#).
- A motion was made by Catherine Barrett and seconded by Allison Heck to approve SOFTlab's public art concept proposal for the yet-to-be-named King Street Waterfront Park. The motion passed 13-0-0, see [Attachment 13](#).

3. AlexRenew Artist in Residence Task Force

- Chris Kurowski and Diane Ruggiero gave an overview of the draft Project Plan for the First Residency for the AlexRenew Public Art Residency, see [Attachments 14 and 15](#).
- Diane Ruggiero clarified that there will be three different projects over the seven years of the project. The current call is budgeted for \$35,000 and future projects will need to be worked into future work plans.
- Chris Kurowski expressed his belief that AlexRenew is fully onboard for the duration of the project and will be doing marketing around the project.
- A motion was made by Gayle Converse and seconded by Allison Heck to approve the Project Plan for the first phase of the AlexRenew Public Art Residency. The motion passed 13-0-0, see [Attachment 16](#).

4. Art Purchase Award Task Force

- Matthew Harwood gave an overview of the task force recommendations for the three art purchase awards recipients, see [Attachment 17](#).
- Allison Nance expressed a desire to have a conversation about lighting and display of the collection so there is a plan in place as the collection grows.
- A motion was made by Allison Heck and seconded by Allison Nance to approve the task force recommendations for art purchase award and honorarium recipients. The motion passed 12-0-0, see [Attachment 18](#).

VIII. FY2019 Budget Priorities

1. Matthew Stensrud led discussion regarding the City Manager's request for FY2019 Budget Priorities.

- The Commission discussed the benefits of tying priorities to the Arts and Culture plan.
- Diane Ruggiero shared that Staff's main priorities are public art and community programming. They are also seeking funding for a full time Public Art Manager.

2. A motion was made by Allison Heck and seconded by Susie Cohen to approve fiscal year priorities as presented in the Commission meeting. The motion passed 12-0-0, see [Attachment 19](#).

IX. Liaison Reports – 10 minutes

1. Waterfront Commission Liaison – No report given.
2. Arts Alliance Liaison – No report given.

X. New Business – None.









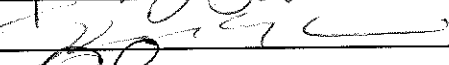
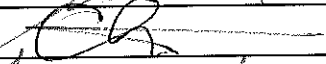
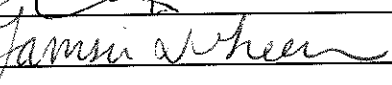
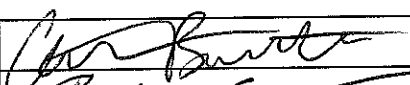
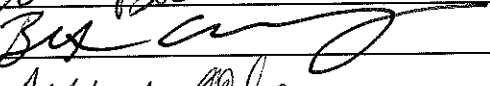

XI. Good of the Order and Announcements – None.

XII. Adjournment (10:35pm)

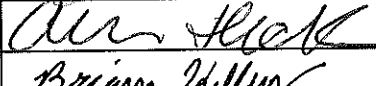
ATTENDANCE SIGN-IN SHEET
ALEXANDRIA COMMISSION FOR THE ARTS
ALEXANDRIA, VIRGINIA

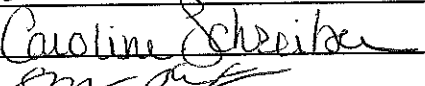
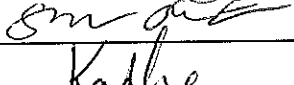
Meeting Date: _____
 Regular Special

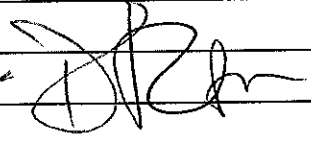
Quorum Meeting Place: Lee Center

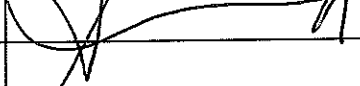
MEMBERS OF COMMISSION:	(Please sign name.)
Matthew Stensrud, Chair	
Gayle Converse, 1 st Vice Chair	
Chris Kurowski, 2 nd Vice Chair	
Tamsin Green, Secretary	
Marta Ali	
Catherine Barrett	
Beth Coast	
Susan Cohen	
Shirley Downs	
Susan Amber Gordon	
Allison Heck	
Brian Kelley	
Allison Nance	
Caroline Schreiber	
Shaan Shuster	
Kadhambari Sridhar	
Recreation, Parks & Cultural Activities Staff:	
James Spengler, Director	
Diane Ruggiero, Deputy Director, Cultural Arts	<i>Diane was in attendance</i> 
Cheryl Anne Colton, Program Director	
Matthew Harwood, Public Art Manager	

TYPICAL AGENDA

- (Time: _____)
- I. Call to Order
 - II. Minutes of Previous Meeting
 - III. Announcements and/or Guest(s)
 - III. Reports:
 - IV. Special Orders
 - V. Unfinished Business
 - VI. New Business
 - VII. Other Announcements
 - (Time: _____) VIII. Adjournment

(Guest(s) Attendance, over)

Alexandria Commission for the Arts

Regular Meeting

Tuesday, October 16th, 2018

Lee Center --- 7:00pm

AGENDA

- I. Call to Order (7:00pm)
- II. Presentation – QuinTango, Joan Singer, Founder and Music Director
- III. Public Comment
- IV. Approval of Minutes – 5 minutes
 1. September 18th Regular Meeting
- V. Chair Report – 10 minutes
- VI. Grants Committee, Allison Nance – 50 minutes
 1. FY2019 Grants
 - Presentation on Use of Remaining Funds, Diane Ruggiero
 - Motion on FY2019 Grants
 2. FY2020 Grants
 - Presentation on Program Modifications, Diane Ruggiero
 - Arts Grants Program Discussion
 - Motion on November Public Hearing
- VII. Office of the Arts Division Update, Matthew Harwood and Diane Ruggiero – 40 minutes
 1. Torpedo Factory Community Engagement Task Force – Catherine Barrett and Beth Coast
 - Receiving of Final Report
 2. King Street Waterfront Park Task Force – Allison Nance and Susie Cohen
 - Motion on Public Art Concept Proposal
 3. AlexRenew Artist in Residence Task Force – Beth Coast and Chris Kurowski
 - Motion on Project Plan
 4. Art Purchase Award Task Force – Allison Heck and Allison Nance
 - Motion on Art Purchase Awards and Honorariums
- VIII. FY2019 Budget Priorities – 20 minutes
 1. Discussion
 2. Motion on Budget Priorities for Letter to City Manager
- IX. Liaison Reports – 10 minutes
 1. Waterfront Commission Liaison – Susie Cohen
 2. Arts Alliance Liaison – Amber Gordon
- X. New Business – 10 minutes
- XI. Good of the Order and Announcements – 5 minutes
- XII. Adjournment (9:30pm)

**Alexandria Commission for the Arts
October 16th, 2018 Regular Meeting
Chair Report
Submitted by Matthew Stensrud**

Hellos and Goodbyes - Welcome to Caroline Schreiber, our new Commissioner with expertise in the arts, who was appointed by City Council on Tuesday, October 9th. Caroline currently manages institutional giving at the Kennedy Center and studied theater performance in college. Thank you and welcome to Caroline as she joins us for her first Commission meeting!

Some Things of Note:

September 2018 Minutes - Thanks to Tamsin Green for her continued work on the minutes.

Visiting Other Boards and Commissions - Continue to let me know if you visit another board or commission so you can share out to the Commission.

Committees on Break - Because of the other things on October's agenda, committee reports will be presented at our November meeting. Committee chairs are always welcome to submit any October reports in writing to be included in the minutes and disseminated to the Commission.

2018 Voting Stickers Design Poll - Over 1,300 votes were received and the final designs have been selected! Thanks again to Catherine Barrett and Anna Leider, the General Registrar, for their work in bringing this project to life. Check out the news release we have put together to celebrate this project!

On the Agenda:

FY2019 Grants - The Commission has received recommendations from staff and feedback from the grants committee over the past two regular Commission meetings regarding the remaining \$13,500 in funds for the FY2019 arts grants. Based on feedback from the Commission, the grants committee, and the community on the initial recommendation, staff and Grants Committee Chair Allison Nance have worked toward a proposal to use the funds for \$1,000 Micro Grants for individual artists and \$2,500 Creative Partnership Grants for collaborative opportunities between artists and businesses or nonprofit organizations. Final details are still being worked on by staff as of this report.

FY2020 Grants - The Commission will be looking at staff's suggestions for modifications to the FY2020 arts grants, with approval of modifications to be considered at our November Regular Meeting. This will include a proposal for all arts grants - including grants to nonprofit arts organizations, micro grants, and other partnership grants, with an approximate budget of \$170,000. I am asking the Commission to consider holding a Public Hearing at our November meeting to receive input from the public on these modifications. Final details are still being work on by staff and Grants Committee Chair Allison Nance as of this report.

Torpedo Factory Community Engagement Task Force - The Task Force met in September to review the Final Report from the community engagement process, prepared by staff and consultants. The Task Force reviewed the report and staff has finalized the report based on Task Force recommendations. Catherine Barrett and Beth Coast, the Commission's Task Force representatives, will present the Final Report along with staff and answer any questions. The Commission is not asked to provide any recommendation based on this report.

For additional information that has led up to this process, this text comes from the City's website (<https://www.alexandriava.gov/recreation/arts/info/default.aspx?id=95569>), along with links to the various other reports:

In March 2016, the Torpedo Factory Art Center Board (TFACB) and the Alexandria Commission for the Arts (ACA) approved the Torpedo Factory Art Center Report by Cultural Planning Group that had been commissioned by the TFACB. The report outlined four recommendations to align the facility for future success. Since then, the City Manager has received three additional reports:

1. Vision for the Torpedo Factory Art Center submitted by Community Members for the Future of the Torpedo Factory
2. A Discourse of the Recommendations for the Torpedo Factory Art Center submitted by the Executive Committees of the TFACB, the Torpedo Factory Artist Association (TFAA), and the President and CEO of The Art League
3. Charting a new Course: Steering the Torpedo Factory Art Center Toward a Sustainable Future: The Business Plan for the Torpedo Factory submitted by the TFAA.

FY2020 Budget Priorities - Last year, for FY2019, the Commission approved priorities to *Sustain Operating and Program Arts Grants* and *Establish a Community Engagement Grant*. The Commission also asked the City Manager to *Ensure Special Events Funds are not drawn from Arts and Culture Funds* and, if cuts were needed, offered *Decreasing Funds for the Mobile Arts Lab* and *Decreasing Funds for Low-Attendance Programming* as options to consider.

This year, for FY2020, the City Manager has asked the Commission to provide priorities, considerations for cuts if necessary (low priorities), and where additional resources should be applied if possible. The Executive Committee discussed this request at our October meeting and is suggesting the Commission consider priorities that sustain our arts grants program, grow our micro grants and other partnership grants, and focus on a specific goal from the Arts and Culture Plan. For considerations of cuts, the Executive Committee discussed optimizing the use of the Durant Center. For where additional resources could be used, growing the grants program and hiring a Public Art Program Specialist were discussed. The Commission will formalize a list of priorities based on the City Manager's request and approve them at our October meeting.

Social Media Tips

Join us on Facebook and Instagram!

Facebook --- <https://www.facebook.com/AlexandriaArtsCommission/> **411 likes +4 since September '18**

Instagram --- <https://www.instagram.com/alexandriaartscommission/> **1,115 followers +50 since September '18**

Upcoming Dates

Executive Committee Meeting, Unknown Due to Election Day

Regular Meeting, Wednesday November 14th, 7pm, Location TBD

Workshops on Funding for Recreation, Parks and Cultural Activities:

Wed, Oct. 17th 3-4:30pm, Glory Days Grill Community Room, 3141 Duke Street

Wed, Oct. 17th 6:30-8pm, William Ramsay Rec Center, 5650 Sanger Ave.

Thurs, Oct. 18th 9:30-11am, Charles Houston Rec Center, 901 Wythe Street

Thurs, Oct. 18th 3-4:30pm, St. Martin de Porres Senior Center, 4650 Taney Ave.

Thurs, Oct. 18th 7-8:30pm, Durant Center, 1605 Cameron Street

Creative Partnerships Grant:

- Funding is for a business with a physical location in the City of Alexandria, or a non-profit organization based in the City of Alexandria, to work with an artist to create a new artwork or project that will benefit residents of the City of Alexandria.
- 3 x \$2,500 grants
- 1:2 match required

Applications to be considered are:

- Project must take place within the City of Alexandria, VA.
- Project in which the creation of an artwork is central
- Project in which an active, authentic working partnership between the artist(s), organization or business is central to the work's development
- Project demonstrates that the artist(s) will be appropriately compensated for their time and efforts toward this project.
- Project in which the artist(s) functions primarily as an artist, not as a teacher, an art therapist, or in another capacity
- Project is accessible to the general public
- The grant funds expenses must be used on artistic time, materials and equipment, and/or other directly related expenses

Criteria for Eligibility

- Project must comply with City codes and ordinances and obtain all related permits
- Project cannot contain any religious or political references
- Special consideration will be given to partnerships that include an artist(s) from the DC Metro region.
- Employees of the City of Alexandria and members of the Alexandria Commission for the Arts' and their immediate family members are not eligible to apply.
- Organizations that have received a grant within this same Fiscal Year from the Office of the Arts are not eligible to apply.

Application:

1. Describe your project including project location, proposed timeline, and how the project will benefit City of Alexandria residents. If there are multiple partners involved with this project, who are they and what is their role. (Up to 450 words)
2. Artist Bio in paragraph form. (Up to 200 words)

Describe which goal/s from the Arts and Culture Master Plan the proposed project supports and how the project aligns with said goal. (400 word limit):

1. Achieve equity, inclusion, and access for the arts, cultural and creative endeavors.
2. Facilitate opportunities for innovation and collaboration.
3. Support and foster a sustainable and diverse community of the arts.
4. Be a convener and facilitator for artistic cultural expression.

Amount requested. (Up to \$2,500):

Provide a list of the direct costs of the entire project including the matching funds. Indicate where the grant funds will be applied.-(Up to 350 words)

Attachments

- One Page Artist Resume
- Five images of artist work samples
- Letter of agreement between the artist(s) and the applicant
- If there are multiple partners, attach letters of support from all partners.
- If this is a mural, attach a letter or agreement from the property owner where the mural will be placed.

Micro Grants for Individual Artists

- Funding for individual artists for community-based arts and culture projects.
- 6 x \$1,000 grants
- No match required

Successful applications will demonstrate projects that creatively address at least one of the below goals through community-engaged projects.

1. Celebrates cultural, ethnic, and racial diversity throughout Alexandria
2. Engages with underserved communities, neighborhoods, or populations of the City of Alexandria
3. Addresses issues related to environmental sustainability
4. Promotes mental and physical well-being, and a happy, active lifestyle

Criteria for Eligibility:

- Project must take place within the City of Alexandria, VA.
- Application is open for projects in any media.
- Artist applicant must be over 18 years of age.
- Project must comply with City codes and ordinances and obtain all related permits.
- Project cannot contain any religious or political references.
- Employees of the City of Alexandria and members of the Alexandria Commission for the Arts' and their immediate family members are not eligible to apply.
- Individual artists who are affiliated with organizations that have received FY2019 grant funding from the Office of the Arts may apply for a microgrant. However, the microgrant may not be used for a project that is fully or partially funded by the organization's previously awarded FY2019 grant.
- Project must be free and open to the public
- Project must benefit residents of the City of Alexandria.
- Applicants may request up to \$1,000 to be used directly on physical resources or activities that will further their community-based project. Usage of funds may include but is not limited to: artistic time, materials, and equipment, or exhibition/performance-related expenses.

Application:

1. Describe your activity, program or project. (Up to 350 words)
2. What is the expected community engagement impact? (Up to 250 words)
3. How will success be measured? (Up to 250 words)
4. Artist Bio in paragraph form. (Up to 200 words)

Amount requested (Up to \$1,000):

Provide a list of the direct costs to which grant funds will be applied with descriptions. (Up to 350 words)

Attachments:

- One page Artist Resume
- Five images of work samples
- Artwork list that corresponds with images to include artwork title, medium, size, and year. Include a short description if needed. For video work, provide a web link (i.e. youtube or vimeo)

City of Alexandria, Virginia

MEMORANDUM

DATE: OCTOBER 12, 2018
TO: ALEXANDRIA COMMISSION FOR THE ARTS
FROM: DIANE RUGGIERO, DEPUTY DIRECTOR PARKS & CULTURAL ACTIVITIES, OFFICE OF THE ARTS
RE: FISCAL YEAR 2019 ARTS GRANTS – REMINING FUNDING

Background:

As part of the FY19 grant cycle, the Arts Commission agreed to set aside \$13,500 for a “community engagement grant”. In accordance with the approved Arts and Culture Master Plan, two new grant opportunities that support the goals and recommendations in the Plan have been developed.

Discussion:

Microgrants: up to \$1,000 non-matching

Arts & Culture Master Plan Goal 3.2.7 - Neighborhood Celebrations Program Fund: Create a fund for community-led celebrations encouraging cross-cultural exchange and widening access opportunities for residents and visitors. This provides funding along with management and technical support from the Office of the Arts. Part of the program will include a database of information to strengthen the capacity of the program.

Microgrants are available for projects and/or programs that are free, open to the public and benefit City of Alexandria residents. Successful applications will demonstrate that the project supports community representation and cultural respect, encourages cultural diversity and/or enhances underserved communities, neighborhoods or populations of the City of Alexandria. Staff approval with notification to the Alexandria Commission for the Arts.

Criteria for Eligibility

- Application is open for projects in any media.
- Eligible artists must be over 18 years of age who live, work or study in the city of Alexandria one year prior to applying and one year during the grant year if awarded.
- Applicants may request up to \$1,000 to be used directly on physical resources or endeavors that will further their community based project.
- Proposed usage of funds may include, but is not limited to: artistic time, materials and equipment, or exhibition/performance - related expenses.
- Projects must take place within the City of Alexandria, VA.
- Projects must comply with City codes and ordinances and obtain all related permits.
- Projects cannot contain any religious or political references.
- Employees of the City of Alexandria and members of the Alexandria Commission for the Arts' and their immediate family members are not eligible to apply.
- Artists and/or organizations that have received a grant from the Office of the Arts are not eligible to apply.

Creative Partnership Grants: up to \$2,500 with a 2:1 cash match

Arts & Culture Master Plan 3.2.5 - Special Opportunities, Risk and Innovations Fund: Create a fund to incentivize entrepreneurial activity, develop innovative programs, and in special circumstances, to build programmatic or organizational capacity. A competitive grant is awarded each cycle and is open to existing arts organizations, other organizations providing or considering cultural programming, as well as one-time projects developed by non-cultural organizations. These are one-time investments in ideas, regardless of organizational budget size. It is recommended that individuals be eligible as well as organizations.

Funding is for Alexandria businesses to engage artists to create new art-centered projects which benefit the community. Each year, the "art-centered project" would have a specific focus. Two-step process with the Alexandria Commission for the Arts to approve the proposed project and artist with a second step to approve the project.

Applications to be considered are:

- Projects in which the creation of an artwork is central
- Projects in which an active, authentic working partnership between the artist(s), organization or business is central to the work's development
- Projects in which the artist(s) functions primarily as an artist, not as a teacher, an art therapist, or in another capacity
- Projects that challenge artistic imagination and organizational thinking
- Projects that are accessible to the general public
- Projects must take place within the City of Alexandria, VA.

Criteria for Eligibility

- The collaborations for FY19 grants are to be focused on murals private property throughout the city.
- Applicants may request up to \$2,500 to be used directly on artistic time, materials and equipment, and other related expenses.
- Projects must comply with City codes and ordinances and obtain all related permits
- Projects cannot contain any religious or political references
- Special consideration will be giving to projects that engage artists from the DC Metro region.
- Employees of the City of Alexandria and members of the Alexandria Commission for the Arts' and their immediate family members are not eligible to apply.
- Artists and/or organizations that have received a grant from the Office of the Arts are not eligible to apply.

Motion made by:	Motion seconded by:	Vote count
Kadhambasi Seidhar	Chris Kucowski	Yes— 15 No— 0 Abstained— 0

ACA Motion

Agenda Item #:

Motion: To approve FY 2019 Ask Grants Remaining Funds Memo as edited by the Grants Committee, with any discrepancies to be finalized by staff and the Grants Committee.

Discussion notes:

(continue on other side of page if necessary)

City of Alexandria, Virginia

MEMORANDUM

DATE: OCTOBER 16, 2018
TO: ALEXANDRIA COMMISSION FOR THE ARTS
FROM: DIANE RUGGIERO, DEPUTY DIRECTOR PARKS & CULTURAL ACTIVITIES, OFFICE OF THE ARTS
RE: FISCAL YEAR 2020 ARTS GRANTS

Background:

Since 1985 the City of Alexandria has been offering an Arts Grant and has awarded over \$4.5 million to local arts organizations and artists. As noted in the Arts and Culture Master Plan "Since 1985, the AGP has awarded grants to 61 different organizations and 30 individual artists. Of the 61 organizations, 28% (17) have received funding for 15 or more years; 15% (9) between 10 and 15 years; 22% (14) between 3 and 9 years; and 35% (21) received program funding only once or, in a few instances, twice."

Discussion:

In accordance with other grants offered by City, the Arts Grant program will offer a "Program Grant" and an "Emerging Organization" Grant for FY20.

This shift will enable the Office of the Arts to better track and measure outcomes of grant organizations and emphasizing the community impact of the grant organizations.

Funding Outline

Program Grants

- Up to \$12,000 not to exceed 50% of the program cost
- 50% of the grant funding can be used for overhead (venue rentals, staff, etc.)
- Funding cannot be used to purchase capital equipment
- Scalable, not below 20% of request

Emerging Organization Grants

- \$15,000
- 2-year grant with a 1-year renewal
- Up to 2 grants per fiscal year
- Not scalable

Grant eligibility, funding cycles, and review process would not be changed. Grants would go live in February (due at the end of March), reviewed by the panel in April, funding recommendations presented to the Arts Commission in May, grants awarded in July.

Motion made by:	Motion seconded by:	Vote count
KUROWSKI	DOWNS	Yes— 14 No— 0 Abstained— 0

ACA Motion

Agenda Item #:

Motion:

HOLD PUBLIC ~~FORUM~~ HEARING AT THE

WEDNESDAY, 14 NOV ACA REGULAR MEETING

TO DISCUSS THE OFFICE OF THE ARTS

PROPOSED FISCAL YEAR 2020 ARTS GRANTS PROGRAM

Discussion notes:

(continue on other side of page if necessary)

OFFICE OF THE ARTS DIVISION SUMMARY

This summary is a brief narrative of activities and actions that have been taken since the previous Division Update. The Office of the Arts ACA Update is also shared with other Recreation, Parks & Cultural Activities commissions and staff and becomes part of the monthly minutes for the Arts Commission.

If you have any questions or require additional information/clarification please review the following section(s) of this report or contact the appropriate staff in the Office of the Arts.

Highlights

- The installation of the play art at Simpson Park is scheduled for the week of October 22, 2018. An artist reception is scheduled for Tuesday, October 23 (rain date Wednesday, October 24). Details available soon.
- The Art Purchase Award Task Force met on September 19, 2018 to review and recommend artwork for purchase.
- The AlexRenew Public Art Artist in Residence Task Force met to review and recommend the project plan for the first of three residencies.
- As requested by Friends of Rocky Versace, a name and gold star will be added to the memorial per the artist's recommendations and approval.
- The conservation assessment is scheduled to be completed before the end of October 2018. Similar to the 2013 assessment, works on public and private property will be assessed.

Public Art - Quick Update:

Public Art Project	Status
Artist Residency (AlexRenew)	Setting Project Goals & Parameters
Burke Library	Setting Project Goals & Parameters
Trails & Paths	Setting Project Goals & Parameters
King Street Park at the Waterfront	Planning/Design
Simpson Park	Installation
Duke Street Tunnel (ZeroZero Collective)	Fabrication
Duke Street Tunnel (M. McConnell)	Fabrication

Staff Contact Info:

Diane Ruggiero
Deputy Director, RPCA
Director, Office of the Arts
diane.ruggiero@alexandriava.gov
703.746.5590

Matthew Harwood (commission liaison)
Public Art Manager
matthew.harwood@alexandriava.gov
703.746.5432

Cheryl Anne Colton
Regional Program Director, Cultural Resources
cherylanne.colton@alexandriava.gov
703.746.5565

Brett Johnson
Regional Program Director, Torpedo Factory Art
Center
brett.johnson@alexandriava.gov
703.746.4577

PUBLIC ART PROJECTS – PLANNING/DESIGN PHASE

Trails & Paths

Lead Agency

Office of the Arts

Project Scope

Develop a plan to implement public art along trails and paths in the city.

Task Force Members

Shirley Downs, Allison Heck, Park Planning Rep, T&ES Rep

Current Status (per project development process)

Setting Project Goals & Parameters

Update

The task force met to review goals and options for the plan.

Next Steps

The task force will be convened in November to review the final draft of the plan.

Anticipated Completion

Ongoing

King Street Park at the Waterfront

Lead Agency

Office of the Arts

Project Scope

Hire a curator/consultant to develop the public art program plan and commission projects for the site.

Task Force Members

Allison Nance, Susan Cohen, Claire Mouledoux, Clint Mansell, Jack Browand

Current Status (per project development process)

Planning/Design

Update

The proposed design is scheduled for approval by the Arts Commission in October.

Next Steps

Once the design is approved, SOFTlab will move into final design and fabrication for installation in March, 2019. Staff and the consultant team are working on additional commissioned programming to support the artwork. The Task Force will be meeting in November to begin the selection process for the 2020 art installation.

Anticipated Completion

Spring, 2019 (1st installation)

Residency (with AlexRenew)

Lead Agency

Office of the Arts

Project Scope

Hire a curator/consultant to develop a public art artist in residency program with AlexRenew.

Task Force Members

Beth Coast, Chris Kurowski, Matthew Clark, Lisa Van Riper, Caitlin Feehan

Current Status (per project development process)

Setting Project Goals & Parameters

Update

The Task Force met with the consultant team in October to develop the project plan and call to artists. The Arts Commission is scheduled to approve the plan in October.

Next Steps

Once the plan is approved the artist call will issued.

Anticipated Completion

Round 1 – Fall, 2019



Duke Street Tunnel

Lead Agency

Office of the Arts

Project Scope

Update artwork in the Duke Street Tunnel

Task Force Members

Betsy Hennigan, Gayle Converse, Katherine Carraway, Tamsin Green, Kim Barnes

Current Status (per project development process)

Fabrication

Update

ZeroZero Collective will begin fabrication and installation of the project this Fall. This will be coordinated with Mike McConnell's art installation.

Next Steps

Staff will work with the artists on installations.

Anticipated Completion

Fall, 2018

Burke Library

Lead Agency

Office of the Arts

Project Scope

Outdoor public art at Burke Library.

Task Force Members

Catherine Barrett, Shirley Downs

Current Status (per project development process)

Setting Project Goals & Parameters

Update

The task force met in June to review the project plan.

Next Steps

Staff is working to identify community stakeholders before completing the project plan

Anticipated Completion

Spring, 2019

PUBLIC ART PROJECTS – FABRICATION/CONSTRUCTION PHASE

Simpson Park Playground

Lead Agency

Office of the Arts

Project Scope

Add a public artist to the design team to integrate and install public art as part of the playground restoration.

Task Force Members

Paul Linehan, Laura Fries, Dana Wedeles, and Lardner/Klein

Update

May + Watkins have begun fabrication of the artworks for the playground.

Next Steps

Installation of the play art and 1 pod is scheduled for October. The 2nd pod and the gate will be installed in November.

Anticipated Completion

Fall, 2018



MISCELLANEOUS PROJECTS

Art Purchase Awards

Lead Agency

Office of the Arts

Project Scope

Invite regional artists to submit original two-dimensional artwork for purchase consideration by the City.

Task Force Members

Allison Nance, Maya Contreras, Joyce Frank, Kate Elkins, Nina Carpenter

Update

The Task Force met and has made a purchase recommendation.

Next Steps

The next call is scheduled to be issued in early 2019.

Anticipated Completion

Ongoing

Potomac Yards Metro

Lead Agency

WMATA

Project Scope

Include public art in the new Potomac Yards metro station.

Task Force Members

N/A

Next Steps

WMATA will select their members for the public art jury.

Anticipated Completion

TBD

Torpedo Factory Art Center Community Engagement Process

Lead Agency

Office of the Arts

Project Scope

The engagement process will develop a set of goals and strategies for the TFAC (phase 1). This will help determine the appropriate governance structure (phase 2) for successful continued operation and long-term sustainability.

Task Force Members

Catherine Barrett, Beth Coast, Antonio Melus, Danielle Romanetti, Lisa Schumaier

Update

The Task Force met and received the results of the survey process.

Next Steps

The report will be submitted to the Arts Commission in October.

Public Art Task Force Roster

Public Art Project Task Force

The Commission for the Arts will form an ad hoc Public Art Project Task Force for each project that the Program undertakes. The ad hoc Task Force will convene on an as needed basis to advise on the development of each project.

The Task Force will: Advise Office of the Arts staff on the development of an Public Art Project Plans and recommend the Plan to the full Commission; Review artist portfolios and recommend selection of an artist to the full Commission; Report to the Commission on its activities on a monthly basis, and; Review artist concepts and recommend approval of concepts to the full Commission.

Simpson Park Public Art

1. Vacant (Arts Commissioner)
2. Vacant (Arts Commissioner)
3. Elisabeth Lardner (proj. stakeholder)
4. Dana Wedeles (proj. stakeholder)
5. Laura Fries (comm. stakeholder)
6. Paul Lineham (comm. stakeholder)

Artist Residency (AlexRenew)

1. Beth Coast*
2. Chris Kurowski*
3. Alex Renew Staff (proj. stakeholder)
4. Matthew Clark (comm. stakeholder)
5. TBD (comm. stakeholder)

TFAC Community Engagement

1. Catherine Barrett*
2. Beth Coast*
3. Lisa Schumaier (proj. stakeholder)
4. Danielle Romanetti (comm. stakeholder)
5. Antonio Melus (comm. stakeholder)

Art Purchase Award

1. Allison Nance*
2. Allison Heck*
3. Maya Contreras (proj. stakeholder)
4. Joyce Frank (comm. stakeholder)
5. Nina Carpenter (comm. stakeholder)

Trails & Paths

1. Shirley Downs*
2. Allison Heck*
3. Ramiro Ross (proj. stakeholder)
4. Robert Narvaez (proj. stakeholder)
5. TBD (comm. stakeholder)
6. TBD (comm. stakeholder)

Duke Street Tunnel

1. Gayle Converse*
2. Tamsin Green*
3. Katherine Carraway (proj. stakeholder)
4. Betsy Hennigan (comm. stakeholder)
5. Kim Barnes (comm. stakeholder)

Burke Library

1. Catherine Barrett*
2. Brian Kelley*
3. Kyle Maier (proj. Stakeholder)
4. Kathleen Schloeder (proj. stakeholder)
5. Vacant (comm. stakeholder)
6. Renee Dipilato (ex-officio)
7. Shirley Downs (ex-officio)

King St Park @ Waterfront

1. Susie Cohen*
2. Allison Nance*
3. Jack Browand (proj. stakeholder)
4. Claire Mouldoux (comm. stakeholder)
5. Clint Mansell (comm. stakeholder)
6. Vacant (comm. stakeholder)

*Arts Commissioner

Public Art Planning & Project Development Process

	DESCRIPTION
Identifying the Project in the Annual Plan	<ul style="list-style-type: none"> Projects are identified in the Public Art Workplan, a document developed annually by the Office of the Arts with input from the Workplan Task Force. The Public Art Workplan is approved by the Arts Commission and by City Council.
Setting Project Goals and Parameters	<ul style="list-style-type: none"> Once a project has been initiated, the Arts Commission establishes a Public Art Project Task Force specifically for that project. Office of the Arts staff, with input from the Project Task Force, develops a Public Art Project Plan. This plan includes goals, location, timeline and budget; the artist selection process and community engagement process; and a list of internal and external stakeholders for the project. The Project Plan is approved by the Arts Commission.
Developing the Artist Pool	<ul style="list-style-type: none"> Based upon the approved Project Plan, the Office of the Arts develops a pool of artists and collects qualifications for the Project Task Force to review. The pool of artists can be collected through an open competition, pre-qualified artist list, curatorial process or invitational. Artist qualifications generally include a cover letter from the artist expressing their interest in the project, a resume, and examples from the artist's portfolio with a corresponding description of each project.
Selecting the Finalists	<ul style="list-style-type: none"> The Project Task Force reviews artist qualifications based on criteria outlined in the approved Project Plan. Depending on the process in the approved Project Plan, the Project Task Force can select a single artist based upon qualifications, or a small number of finalists (generally three to five).
Selecting the Artist	<ul style="list-style-type: none"> If finalists are selected, they may be: <ul style="list-style-type: none"> Paid a stipend to develop a concept proposal and present that proposal to the Project Task Force. Interviewed by the Project Task Force. A combination of the above. The Project Task Force recommends selection of an artist to the Arts Commission based upon the Concept Proposal and/or interview.
Approving the Contract	<ul style="list-style-type: none"> The Office of the Arts develops a contract agreement with the artist. The agreement is approved by the City Manager or City Council, depending on the size of the contract.
Approving the Concept Proposal	<ul style="list-style-type: none"> The selected artist develops a Concept Proposal, if that was not a part of the artist selection phase. The Office of the Arts facilitates community engagement conducted by the artist as part of their process of developing a Concept Proposal. The Project Task Force reviews the Concept Proposal and recommends it to the Arts Commission for approval.
Approving Final Design	<ul style="list-style-type: none"> The Office of Arts conducts a review of the final design documentation provided by the artist for both technical considerations and to ensure it is in conformity with the approved concept proposal. The Office of the Arts facilitates technical reviews by other City staff as required. The Office of the Arts signs off on the Final Design.
Fabrication	<ul style="list-style-type: none"> In most cases, the artist is responsible for fabrication. The Office of the Arts monitors fabrication to ensure it is on schedule and in conformity with the approved design. In some cases, the Office of the Arts will play a more direct role in overseeing the fabrication of artwork, with the artist acting in an advisory role.
Installation	<ul style="list-style-type: none"> The Office of the Arts works with the artist, relevant City Departments, and other stakeholders to schedule and facilitate installation.

ARTICLE K - Alexandria Commission for the Arts¹¹

- **Sec. 2-4-90 - Creation, composition and organization.**

(a) There is hereby established a standing commission known as the Alexandria Commission for the Arts.

(b) The commission shall consist of 16 members to be appointed by the city council. The composition of the commission shall be as follows:

- (1) four members shall have expertise in the arts, including, but not limited to, arts educators, professional practitioners of various art disciplines and professional administrators working in the arts;
- (2) three members shall have specific expertise in visual arts either as professional practitioners of visual art, curators of visual art, or as professional arts administrators currently working in the field;
- (3) three members shall represent the public at large, as arts consumers or participants;
- (4) three members shall be professionals in fields relevant to arts and cultural development, including cultural planning, marketing, finance, funding, tourism, promotion, non profit organizational development, and real estate development;
- (5) two members shall be professionals in the field related to the visual appearance of the cityscape, such as architecture, environmental design, landscape architecture or urban design; and
- (6) one member shall be a student who resides in the city and attends a high school located in the City of Alexandria.

(c) Members of the commission shall be appointed in the manner prescribed by article A of this chapter. The members shall serve for a term of three years, except in the case of an appointment to fill the unexpired portion of a term. (Ord. No. 3782, 2/25/95, Sec. 1; Ord. No. 4482, 5/12/07, Sec. 1; Ord. No. 4920, 1/24/15, Sec. 1)

- **Sec. 2-4-91 - Function; powers; duties.**

(a) The functions of the commission shall be as follows:

- (1) to advise city council with regard to policies that will strengthen the arts and further public access to the arts and cultural matters identified by the city council;
- (2) to establish and periodically review criteria and standards for arts grant applications for city funds and accountability for the use of such funds; the allocation from such funds to eligible organizations and activities as may be appropriated by the city council for such purpose;
- (3) to review the public art annual work plan as developed by the office of the arts and a work plan task force and make recommendations to the city council as part of the budget process;
- (4) to review and approve public art project plans for specific public art projects, and to review and approve artist selection and concept development;
- (5) to create committees and task forces, as necessary, to focus on public art project development and artist selection;
- (6) to review proposals for donations of public art and commemorative art and make recommendations to the city council;
- (7) to collaborate with the office of the art on public art project evaluations; and
- (8) to support public communication and outreach as related to the arts and;
- (9) to serve as citizen liaisons to city planning initiatives when public art is involved.

(b) The commission is empowered to adopt rules and regulations in regard to procedure and other matters so long as the same are not inconsistent with the city code, including, but not limited to, the establishment of committees, through which to carry on its functions and purpose.

(c) A commission chair, vice-chair and secretary shall be elected annually by the commission members at the organization meeting designated in the commission's bylaws. (Ord. No. 3782, 2/25/95, Sec. 1; Ord. No. 4482, 5/12/07, Sec. 1; Ord. No. 4920, 1/24/15, Sec. 1)

TORPEDO FACTORY
ART CENTER
COMMUNITY
ENGAGEMENT
REPORT



Table of Contents

- ABOUT THE TORPEDO FACTORY ART CENTER 3
- ABOUT THIS REPORT 4
 - Roles and Scope 5
- COMMUNITY ENGAGEMENT PROCESS 6
 - Resident Intercept Survey (Geographically Representative) 6
 - Art League Membership Survey (online) 7
 - Artist Survey (online) 7
- COMMUNITY ENGAGEMENT SURVEYS 8
 - Torpedo Factory Art Center Resident Intercept Survey 9
 - Torpedo Factory Art Center Community Engagement Survey – Art League 19
 - Community Engagement Artist Survey 29
- CITY RESIDENT SURVEY RESULTS 41
- ARTIST SURVEY RESULTS 69
- CITY GOAL 96
- INTERCEPT SURVEY COMMENTS 123
- ART LEAGUE SURVEY COMMENTS 164
- ARTIST SURVEY COMMENTS SORTED 182

ABOUT THE TORPEDO FACTORY ART CENTER

Just south of Washington, D.C., the Torpedo Factory Art Center overlooks the Potomac River in the Old Town section of Alexandria. Built in 1918, this former naval munitions plant created torpedoes during WWII and later the federal government used the space for storage of items such as congressional documents, dinosaur bones from the Smithsonian Institute's collection, and Nazi trial records before the City of Alexandria bought the building in 1969.

In the early 1970s then Art League President Marion Van Landingham partnered with the City of Alexandria and the building was transformed into an art center in 1974 and became a showcase for the nation's largest number of publicly accessible artists' studios under one roof. In 1982 the City supported a full renovation of the building's interior that created the artist studios as they exist today.

Each year, more than a half million national and international visitors meet and interact with more than 130 resident artists in 82 studios and seven galleries 360 days per year. The Torpedo Factory Art Center is also home to The Art League gallery and school, the Alexandria Archaeology Museum, and a café.

The Waterfront Small Area Plan states the importance of the Torpedo Factory Art Center in the past and future development of the waterfront and calls for the City to "take proactive measures to attract new cultural institutions on the Alexandria waterfront that complement its history and existing cultural institutions."

Since its inception, the Art Center has been led by a variety of governance structures including multiple City departments, an artists' organization, and a non-profit organization while continuing to be owned by the City. After deciding to sunset the lease with the Torpedo Factory Art Center Board (who had been leasing the building for the previous 6 years) the City assumed the day-to-day operations and the individual studio and organization leases in October 2016.

In an effort to outline a future path for the Torpedo Factory Art Center, the City commissioned a community engagement process to learn from residents about their experiences at, and expectations of, their Art Center on the waterfront.

ABOUT THIS REPORT

Since 2012, a dozen reports, studies, and surveys have been conducted to provide insight on the operations of the Torpedo Factory Art Center, the role the Arts play in Alexandria, and the City's investment in the Arts on behalf of the community.

1. Alexandria Waterfront Small Area Plan, February 2012 (*City of Alexandria Planning & Zoning, Adopted by Ordinance No. 4749*)
2. City of Alexandria Recreation, Parks & Cultural Activities Strategic Master Plan, 2002 (*Leon Younger and PROS Consulting for the City of Alexandria*)
3. Alexandria Arts and Cultural Master Plan, 2016 (*Cultural Planning Group for City of Alexandria Office of the Arts*)
4. City of Alexandria Office of Arts Public Art Plan, 2014 (*Todd Bressi, Via Partnership, and Lardner Klein for City of Alexandria Office of the Arts*)
5. City Strategic Plan, 2017-2022 (*Reingold, Inc. for City of Alexandria*)
6. Torpedo Factory Art Center Business Analysis & Recommendations, 2016 (*The Cultural Planning Group for the Torpedo Factory Art Center Board*)
7. A Discourse of the Recommendations for the Torpedo Factory Art Center, 2016 (*Torpedo Factory Art Center Joint Executive Committee – Torpedo Factory Art Center Board, Torpedo Factory Artist Association, The Art League*)
8. Audience Research Study: Torpedo Factory Art Center*, 2014 (*Randi Korn & Associates, Inc. for the Torpedo Factory Artist Association*)
9. Charting a New Course: Steering the Torpedo Factor Art Center Toward a Sustainable Future, 2016 (*KAPTIVATE for the Torpedo Factory Artist Association*)
10. A Vision for the Torpedo Factory Art Center: Community Members for the Future of the Torpedo Factory, 2016 (*Community Members for the Future of the Torpedo Factory*)
11. Historic Preservation Plan 8, 2016 (*City of Alexandria Neighborhood Planning & Community Development Division Working Draft*)
12. The Impact of the Torpedo Factory Art Center on the City of Alexandria's Economy, 2017 (*The Stephen S. Fuller Institute for Research on the Washington Region's Economic Future, Schar School of Policy and Government at George Mason University, with analytical support from KAPTIVATE for the Torpedo Factory Artist Association*)

**Content analysis is based on visitor surveys*

On review of these existing studies as a collective body of work, the City, the Arts Commission, and the Task Force concluded that the existing studies had fully engaged and received input from the artists, The Art League, and the arts community. The one stakeholder group that was clearly missing were the general, non-arts related residents of Alexandria. Based on this analysis, the Community Engagement Process was launched to specifically gain input from residents. The preceding reports were used to inform the development of the engagement process.

Roles and Scope

To help guide the process, the Alexandria Commission for the Arts formed a representative Task Force to work with staff and the consultant team:

- Catherine Barrett, Alexandria Commission for the Arts
- Beth Coast, Alexandria Commission for the Arts
- Antonio Melus, Community Stakeholder
- Danielle Romanetti, Business Stakeholder
- Lisa Schumaier, Torpedo Factory Art Center Artist Representative
- Matthew Stensrud, Alexandria Commission for the Arts (ex-officio)

The City hired a consultant team to work with the Task Force and develop the engagement process. The consultant team collected and processed the data, developed the charts, created the goal and the goal's 4 support sections all found in this document:

- Diane Mataraza, Mataraza Consulting (project lead)
- Surale Phillips, Decision Support Partners

Various staff throughout all levels of the City were also engaged in the development and implementation of the Community Engagement Process. Staff provided support to the consultant team and formatted this document based on the information they provided:

- Diane Ruggiero, Deputy Director, Recreation, Parks & Cultural Activities Department
- Nathan Imm, Principal Planner, Department of Planning and Zoning/Neighborhood Planning
- Brett John Johnson, Director, Torpedo Factory Art Center
- Tiana Bady, Registrar, Torpedo Factory Art Center

COMMUNITY ENGAGEMENT PROCESS

To ensure that a variety of voices and perspectives were gathered, the consultant team, with input from the Task Force, developed a community engagement strategy that included a variety of opportunities for people to participate and provide their feedback with the intent of reaching the diverse residents of Alexandria.

Three survey protocols were developed – an intercept survey, an online survey for members of The Art League, and an artist survey. The questions in the intercept survey and the online survey were identical, however the intercept survey (done in person and by phone) were geographically representative and was designed to be the primary survey and has been given more significance. The artist survey was developed to ensure that all points of view were considered.

This report only contains the feedback from participants who indicated they live within the city limits of Alexandria. Additionally, this report combines the results of the Intercept Survey and the Online Survey and is called “City Resident Survey Results”.

Resident Intercept Survey (Geographically Representative)

The intercept survey was conducted through in-person intercepts where staff and volunteers encountered residents at places such as community recreation centers, libraries, at community festivals and events.

The City also hired a polling company to conduct additional intercept surveys by phone in an effort to ensure that the survey input was geographically representative of Alexandria. This audience had varying degrees of familiarity with the Art Center.

Participants	Zip Code
182	22304
160	22314
68	22302
58	22305
56	22301
49	22311
31	22312
604	TOTAL

Art League Membership Survey (online)

The same survey questions that were developed for the intercept survey were distributed online through the membership of The Art League. This audience had a higher level of awareness and familiarity with the Art Center through their relationship with The Art League. Although responses have been sorted to only include responses from residents of Alexandria, the participation is not representative of population statistics.

Participants	Zip Code
141	22314
45	22301
35	22305
32	22304
25	22302
9	22312
2	22311
289	TOTAL

The mingling of The Art League and general residents survey may skew various results toward those familiar with the Torpedo Factory Art Center and increased visitation than may be present in the general resident population. While it did not appear to significantly disrupt the results, further analysis through data separation of the general residents may be beneficial to future outreach and programming efforts.

Artist Survey (online)

An online survey was developed for artists who live in Alexandria, including leaseholders at the Torpedo Factory Art Center, and was distributed with support from The Torpedo Factory Artist Association and The Art League as well as other local arts groups such as The Arts Alliance. Responses have been sorted to only include artists who indicated they reside in the City of Alexandria.

Participants	Zip Code
151	22314
53	22301
45	22302
43	22304
29	22305
13	22312
10	22311
344	TOTAL

COMMUNITY ENGAGEMENT SURVEYS

Torpedo Factory Art Center Resident Intercept Survey

*denotes a required question

All intercept survey questions were asked in person or by phone.

1) Please tell us your ZIP code.*

2) How long have you lived in Alexandria?

- Less than 3 years
- 3-6 years
- 7-10 years
- More than 10 years
- Other (e.g. off and one over the years)

3) Do you generally visit places to see art like museums, galleries, or art shows at least once a year?

- Yes
- No
- Not sure

4) Are you familiar with the Torpedo Factory?*

- Yes
 - No
-

Community Identity

5) Do you think the Torpedo Factory Art Center is important to Alexandria's identity?*

- Yes
- No
- Not sure

6) What do you think makes it important to Alexandria's identity? CHECK ALL THAT APPLY

- Attracts tourists
- Place for artists and arts education
- Place to see art
- Place to see artists working on art
- Adds to reputation of the City
- Unique experience
- People have heard of it/its famous
- Other - Write In:

7) When was the last time you went to the Torpedo Factory? CHECK CLOSEST RESPONSE

- Within last 6 months
 - 6 months to a year ago
 - A year to two years ago
 - More than two years ago
 - Never visited Torpedo Factory
-

Visiting the Torpedo Factory Art Center

8) About how often do you visit the Torpedo Factory? CHECK CLOSEST RESPONSE

- Once per month
- More than 6 times per year
- More than twice a year
- About once a year
- Every few years
- Less than every few years
- Not sure

9) When you visit the Torpedo Factory, why do you go there? CHECK ALL THAT APPLY

- Visit when I'm in the area
- Entertaining out of town visitors
- To look for art to buy
- To watch artists working
- Art exhibits or art openings in galleries
- Special events (not art related)
- Archaeology Museum
- Art League
- General, just to wander around
- Other - Write In:

10) When is it most convenient for you to visit the Torpedo Factory Art Center? CHECK ALL THAT APPLY

- Weekdays, during the day
- Weekdays, in the evening
- Weekends, during the day
- Weekends, in the evening

11) Did you have a positive experience at the Torpedo Factory the last time you visited?

Yes (yes, generally)

No (no, not really)

Not sure

12) What do you like most about the Torpedo Factory? CHECK ALL THAT APPLY

Particular/specific artist studios

Location

Variety of art and artists

Watching artists create

Unique art to buy

Classes

Lots to do there

Interesting/fun atmosphere

Interesting building/history

People are friendly

Other - Write In:

13) Was there something specific that would have made your visit to the Torpedo Factory better? Or if it fell short of your expectations, how so? CHECK ALL THAT APPLY

- Facility not well maintained
 - Wasn't sure what to do there
 - Hours are inconvenient, not open
 - Location is not convenient, hassle
 - Art is too expensive
 - Didn't like anything I saw
 - Nothing new to see, always the same art/artists
 - Didn't feel welcome, artists were not engaging
 - Too many studios closed
 - Did not see any artists working
 - Not enough going on there, boring
 - Nothing for kids to do
 - No good places to eat or drink
 - Other - Write In:
-

Encouraging Visits

14) What would encourage you to visit the Torpedo Factory more often? CHECK ALL THAT APPLY

- More affordable, cheaper art
 - Frequently changing art exhibits
 - Frequently changing artists on display
 - Opportunities to interact with artists
 - More variety or diversity of types of art
 - More artists of color or from different countries
 - More local artists from Alexandria
 - Evening hours when studios are open
 - Dedicated area for events, parties, meetings
 - Variety of restaurants, bars, or cafes
 - Food, wine, beer events
 - More information about what's happening there
 - Opportunities to make art myself (or kids to make art)
 - Outside arts activities on the Waterfront
 - Child-friendly spaces or activities
 - Other - Write In:
-

Alexandria's Waterfront

15) In a typical year, how often do you visit the Alexandria Waterfront?

- Never
- 1-2 times
- 3-6 times
- 7-12 times
- More than 12 times
- Not sure

16) What types of activities would make you visit the Waterfront more often? **CHECK ALL THAT APPLY**

- Live performances
- Visual art galleries/exhibitions
- Vendors with arts and crafts for sale
- Activities where I can make things
- Activities for children
- Community celebrations/festivals
- Food events
- Beer/wine events
- Competitions/races
- Other - Write In:
- Not sure/no response

17) When are you likely to visit Alexandria's Waterfront? CHECK ALL THAT APPLY

Weekdays, during the day

Weekdays, in the evening

Weekends, during the day

Weekends, in the evening

About the Torpedo Factory

18) In case you don't know, the Torpedo Factory is a City-owned facility on the Waterfront in Old Town that provides discounted rates for studio space to artists and arts organizations. Do you feel it is important for the City to provide this type of support to artists and arts organizations?*

Yes

No

Not sure

Artist Residence

19) Is it important that these artists be City residents?

Yes

No

Not sure

Tell Us About You

20) What age group are you in?

- Under 18
- 18-34
- 35-54
- 55-64
- 65 and over
- Prefer not to respond

21) Other than yourself, does your household include people in any of the following age groups?

- Children under age 6
- Youth age 7-12
- Teens age 13-17
- Young adults age 18-24
- Adults age 25-64
- Adults over age 65
- No other household members
- Prefer not to respond

22) Do you primarily speak English at home or with friends?

- Yes
- No, what do you speak at home?:
- Prefer not to respond

23) Is there any other advice you would offer to the City as it plans for the Torpedo Factory's future?

Thank You!

Torpedo Factory Art Center Community Engagement Survey – Art League

*denotes a required question

1) Please tell us your ZIP code.*

2) How long have you lived in Alexandria?*

- Less than 3 years
- 3-6 years
- 7-10 years
- More than 10 years
- Other (e.g. off and one over the years)

3) Do you generally visit places to see art like museums, galleries, or art shows at least once a year?*

- Yes
- No
- Not sure

4) Are you familiar with the Torpedo Factory?*

- Yes
 - No
-

Community Identity

5) Do you think the Torpedo Factory Art Center is important to Alexandria's identity?*

- Yes
- No
- Not sure

6) What do you think makes it important to Alexandria's identity?

- Attracts tourists
- Place for artists and arts education
- Place to see art
- Place to see artists working on art
- Adds to reputation of the City
- Unique experience
- People have heard of it/its famous
- Other - Write In:

7) When was the last time you went to the Torpedo Factory?*

- Within last 6 months
 - 6 months to a year ago
 - A year to two years ago
 - More than two years ago
 - Never visited Torpedo Factory
-

Visiting the Torpedo Factory Art Center

8) About how often do you visit the Torpedo Factory?

- Once per month
- More than 6 times per year
- More than twice a year
- About once a year
- Every few years
- Less than every few years
- Not sure

9) When you visit the Torpedo Factory, why do you go there?

- Visit when I'm in the area
- Entertaining out of town visitors
- To look for art to buy
- To watch artists working
- Art exhibits or art openings in galleries
- Special events (not art related)
- Archaeology Museum
- Art League
- General, just to wander around
- Other - Write In:

10) When is it most convenient for you to visit the Torpedo Factory Art Center?

- Weekdays, during the day
- Weekdays, in the evening
- Weekends, during the day
- Weekends, in the evening

11) Did you have a positive experience at the Torpedo Factory the last time you visited?

- Yes (yes, generally)
- No (no, not really)
- Not sure

12) What do you like most about the Torpedo Factory?

- Particular/specific artist studios
- Location
- Variety of art and artists
- Watching artists create
- Unique art to buy
- Classes
- Lots to do there
- Interesting/fun atmosphere
- Interesting building/history
- People are friendly
- Other - Write In:

13) Was there something specific that would have made your visit to the Torpedo Factory better? Or if it fell short of your expectations, how so?

- Facility not well maintained
 - Wasn't sure what to do there
 - Hours are inconvenient, not open
 - Location is not convenient, hassle
 - Art is too expensive
 - Didn't like anything I saw
 - Nothing new to see, always the same art/artists
 - Didn't feel welcome, artists were not engaging
 - Too many studios closed
 - Did not see any artists working
 - Not enough going on there, boring
 - Nothing for kids to do
 - No good places to eat or drink
 - Other - Write In:
-

Encouraging Visits

14) What would encourage you to visit the Torpedo Factory more often?

- More affordable, cheaper art
 - Frequently changing art exhibits
 - Frequently changing artists on display
 - Opportunities to interact with artists
 - More variety or diversity of types of art
 - More artists of color or from different countries
 - More local artists from Alexandria
 - Evening hours when studios are open
 - Dedicated area for events, parties, meetings
 - Variety of restaurants, bars, or cafes
 - Food, wine, beer events
 - More information about what's happening there
 - Opportunities to make art myself (or kids to make art)
 - Outside arts activities on the Waterfront
 - Child-friendly spaces or activities
 - Other - Write In:
-

Alexandria's Waterfront

15) In a typical year, how often do you visit the Alexandria Waterfront?

- Never
- 1-2 times
- 3-6 times
- 7-12 times
- More than 12 times
- Not sure

16) What types of activities would make you visit the Waterfront more often?

- Live performances
- Visual art galleries/exhibitions
- Vendors with arts and crafts for sale
- Activities where I can make things
- Activities for children
- Community celebrations/festivals
- Food events
- Beer/wine events
- Competitions/races
- Other - Write In:
- Not sure/no response

17) When are you likely to visit Alexandria's Waterfront?

- Weekdays, during the day
 - Weekdays, in the evening
 - Weekends, during the day
 - Weekends, in the evening
-

About the Torpedo Factory

18) In case you don't know, the Torpedo Factory is a City-owned facility on the Waterfront in Old Town that provides discounted rates for studio space to artists and arts organizations. Do you feel it is important for the City to provide this type of support to artists and arts organizations?*

- Yes
 - No
 - Not sure
-

Artist Residence

19) Is it important that these artists be City residents?

- Yes
 - No
 - Not sure
-

Tell Us About You

20) What age group are you in?

- Under 18
- 18-34
- 35-54
- 55-64
- 65 and over
- Prefer not to respond

21) Other than yourself, does your household include people in any of the following age groups?

- Children under age 6
- Youth age 7-12
- Teens age 13-17
- Young adults age 18-24
- Adults age 25-64
- Adults over age 65
- No other household members
- Prefer not to respond

22) Do you primarily speak English at home or with friends?

Yes

No, what do you speak at home?:

Prefer not to respond

23) Is there any other advice you would offer to the City as it plans for the Torpedo Factory's future?

Thank You!

Community Engagement Artist Survey

*denotes a required question

Residence and Basic Information

1) Are you a resident of Alexandria?

Yes

No

2) What is your primary home ZIP code?

3) For how many years have you lived in this ZIP code?

Less than 1 year

1-3 years

4-7 years

8-10 years

More than 10 years

4) Do you earn any part of your living through art?

Yes

No

5) Please estimate the percentage of your annual income that is derived from the following sources. This may include art sales, education or other direct artistic services (Answer must total 100%)*

_____ Your art or creative practice
_____ Full time employment outside your art
_____ Part time employment outside your art
_____ Other

6) Please check all of the artistic disciplines in which you work:

- Architecture
- Design
- Dance
- Craft
- Folk or traditional arts
- Literature
- Media arts, film, video
- Music
- Performing arts
- Photography
- Theater arts
- Visual arts (2D)
- Visual arts (3D)
- Other - Write In:

7) Do you teach an art form?

- Yes
- No

8) If yes, what do you teach?

9) Please rank the following by importance to you as an artist.

Drag and drop items from the left-hand list into the right-hand list to order them. If something is not relevant to you, don't drag it over.

- _____ Opportunities to learn a living as an artist
- _____ Opportunities to connect with other artists or arts organizations
- _____ Resources to develop my artistic practice
- _____ Resources to develop my art business
- _____ Affordable workspace in which to create my art
- _____ Affordable retail space to see my art or service

10) In the past 12 months have you done any of the following with the Alexandria Office of the Arts? Please check all that apply.

- I've never heard of the Alexandria Office of the Arts
- I've heard of the Office of the Arts, but I've never been involved
- Contacted the office for assistance
- Participated in a professional development program
- Participated in research, study, or plan
- Applied for or received a grant
- Participated in Alexandria's Community Supported Arts Program
- Participated in the Mobile Art Lab
- Participated in a program at the Durant Arts Center
- Other - Write In:

11) Where do you turn for technical assistance to support your creative work? Please check all that apply.

- Alexandria Collaborators
- Alternate ROOTS
- City of Alexandria Office of the Arts
- Creative Capital
- Durant Arts Center
- Fractured Atlas
- Virginia Commission for the Arts
- Del Ray Artisans
- Other - Write In:

12) Please check up to five (5) types of professional development that would be of benefit to you as an artist.

- Discounted supplies and/or equipment
- Accountants, tax preparers, bookkeepers, lawyers for artists
- Insurance for artists
- Grants
- Marketing and promotional assistance
- Online database of Alexandria artists
- Opportunities to network with and meet other artists
- Portfolio development
- Other - Write In:

13) In addition to the space you currently use to make your art, what are your space needs at the moment? (If none, go to the next question.)

- Studio space of my own outside my home
 - Studio space I can share with others
 - Space to hold classes
 - Storage space
 - Live/work space
 - Performance venue that doesn't currently exist
 - Rehearsal space
 - Gallery or Co-op space to sell my art
 - A fabrication lab/maker space
 - Office space I can share with others
 - Recording/audio/media studio
 - Other - Write In:
-

Familiarity with Torpedo Factory

14) Are you familiar with the Torpedo Factory Art Center?*

- Yes
 - No
-

Alexandria Identity

15) Do you think the Torpedo Factory Art Center is important to Alexandria's identity?

- Yes
 - No
 - Not sure
-

Alexandria Identity

16) What makes it important to Alexandria's identity?

Affiliation with TFAA

17) Are you a member of the Torpedo Factory Artist Association (TFAA)?*

- Current TFAA member artist
 - Current TFAA associate artist
 - Former TFAA member artist
 - Former TFAA associate artist
 - I have never been a member or affiliated with the TFAA
-

Questions for TFAA Artists/Affiliates

18) What are the benefits of being a TFAA artist or affiliated artist?*

19) What are the challenges of being a TFAA artist or affiliated artist?*

Visiting the Torpedo Factory

20) When was the last time you went to the Torpedo Factor Art Center?

- Within the last month
 - Within the last 3 months
 - Within the last 6 months
 - Between 6 months and a year ago
 - Between a year and two years ago
 - More than two years ago
 - I've never been there
-

About Torpedo Factory Visits

21) About how often do you visit the Torpedo Factory Art Center?

- At least once a month
- More than 6 times a year
- More than twice a year
- About once a year
- Every few years
- Less than every few years

22) Why do you visit the Torpedo Factory Art Center?

- I'm in the area
- Entertaining out of town guests
- To look for art to purchase
- To watch artists at work in studios
- To see exhibits/art openings
- Special events (not art related)
- Archaeology Museum
- Art League classes or shows
- To work in a studio
- General - just to wander around
- Other - Write In:

23) When is it most convenient for you to visit the Torpedo Factory Art Center?

- Weekdays, during the day
- Weekdays, in the evening
- Weekends, during the day
- Weekends, in the evening

24) Did you have a positive experience the last time you were at the Torpedo Factory Art Center?

Yes

No, not really

Not sure, I'm neutral

Torpedo Factory Experiences

25) What did you like most about the Torpedo Factory?

26) In what ways, if any, did the Torpedo Factory Art Center fall short of your expectations? Was there something specific that would have made your experience better?

Ideas for Encouraging Visits to the Torpedo Factory

27) What activities would encourage you to visit the Torpedo Factory more often?

About the Torpedo Factory

28) In case you don't know, the Torpedo Factor Art Center is a City owned facility on the Waterfront in Old Town that provides discounted rates for studio space to artists and arts organizations. Do you feel it is important for the City to provide this type of support for artists?

- Yes
- No
- Not sure

29) Is it important for the artists to be Alexandria residents?

- Yes
- No
- Not sure

Respondent Demographics

30) What is your age group?

- Under 18
- 18-34
- 35-54
- 55-64
- 65 and over

31) Are you of Hispanic or Latino origin?

Yes

No

32) What US Census categories include you? (Check all that apply.)

White/Caucasian

Black/African American

American Indian/Alaska Native

Asian

Hawaiian/Pacific Islander

Multiple races/Mixed race

33) Do you identify with a particular cultural or ancestral group?

Yes

No

34) Which cultural or ancestral group do you identify with?

35) Do you primarily speak English at home or with friends?

Yes

No

36) What is your primarily language at home or with friend?

37) Is there any other information or insight you would offer to the City about the Torpedo Factory Art Center?

Thank You!

CITY RESIDENT SURVEY RESULTS

Chart 1. Respondent ZIP codes

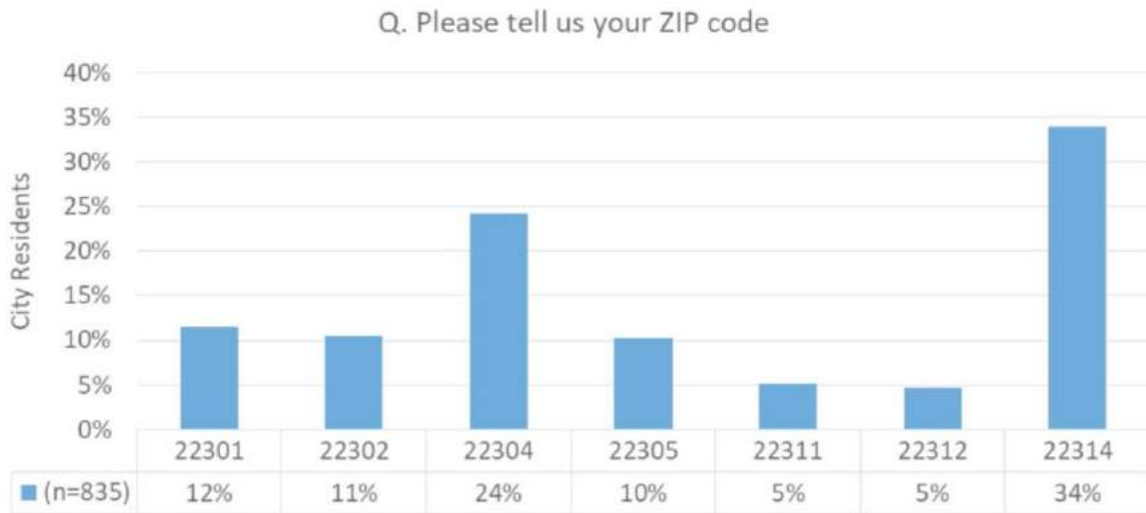
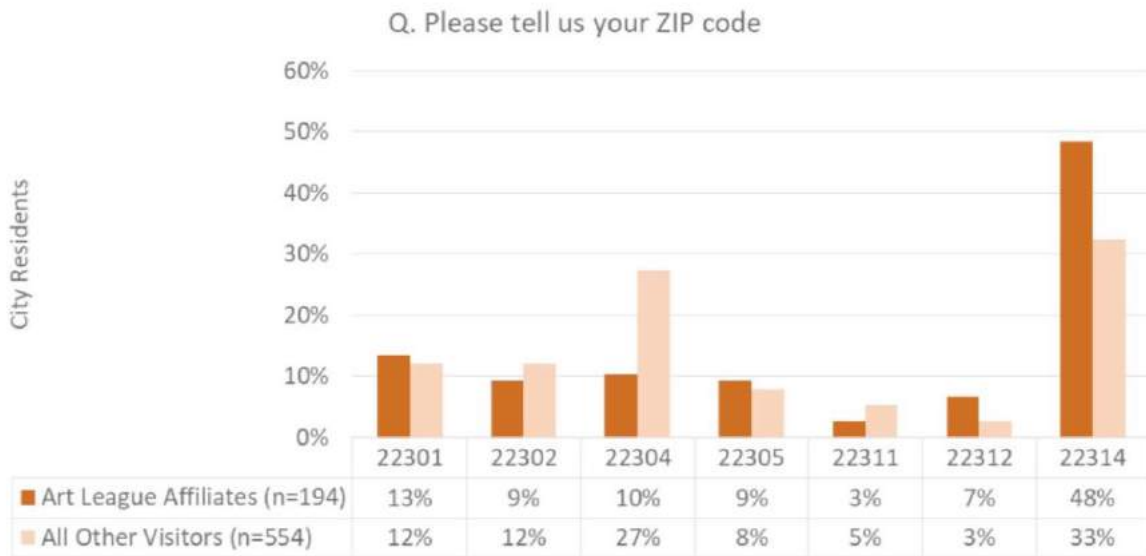

Chart 2. Respondent ZIP codes by Affiliation with The Art League*



* For the purposes of segmentation, Art League Affiliates are defined as respondents who reported that one of the reasons they visit the Torpedo Factory Art Center is for The Art League, which may include classes or other Art League activity. Respondents who did not report Art League activity were included in the all other visitors segment. Because City residents affiliated with The Art League represent a large component of daily users of the TFAC facility, as well as a large portion of the survey sample, segmentation was used to compare responses with other visitors to see if there were substantial variances in responses to the survey questions.

Chart 3. Survey Respondent Length of Residence in Alexandria

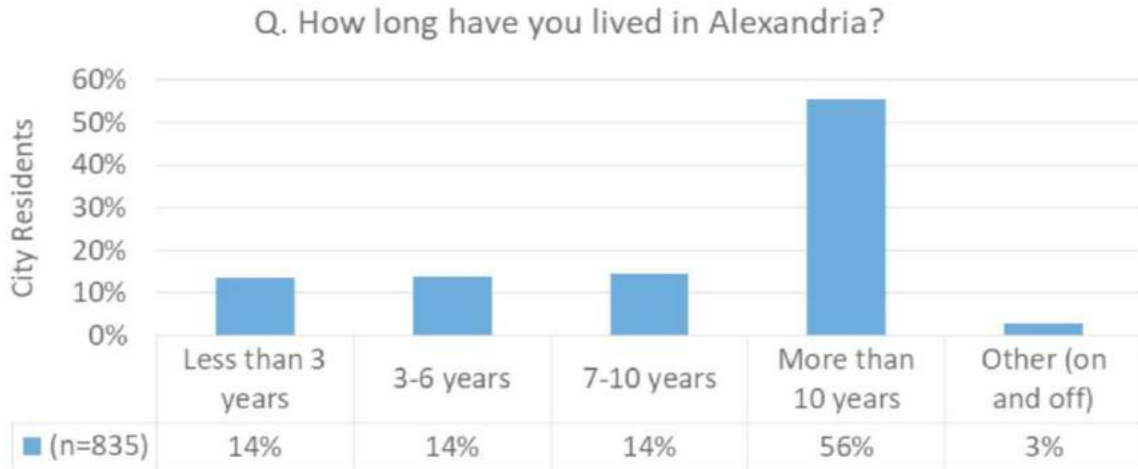

Chart 4. Length of Residence by Affiliation with The Art League

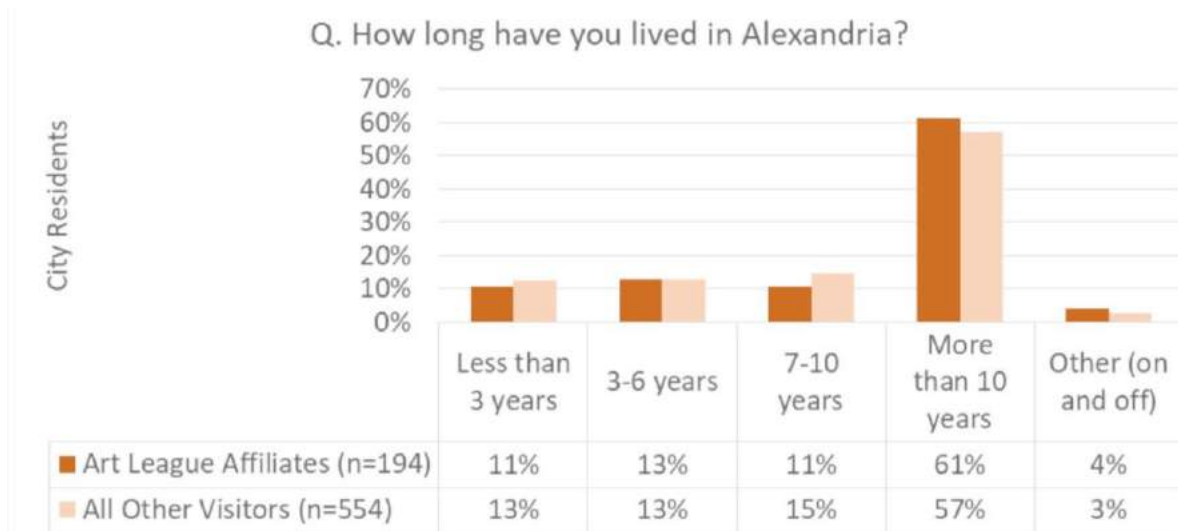

Chart 5. Respondent Familiarity with Torpedo Factory Art Center

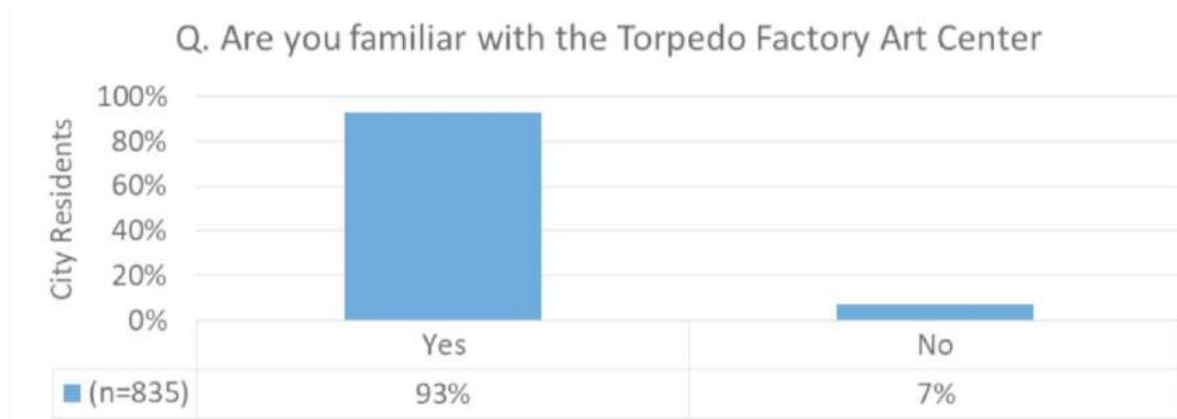
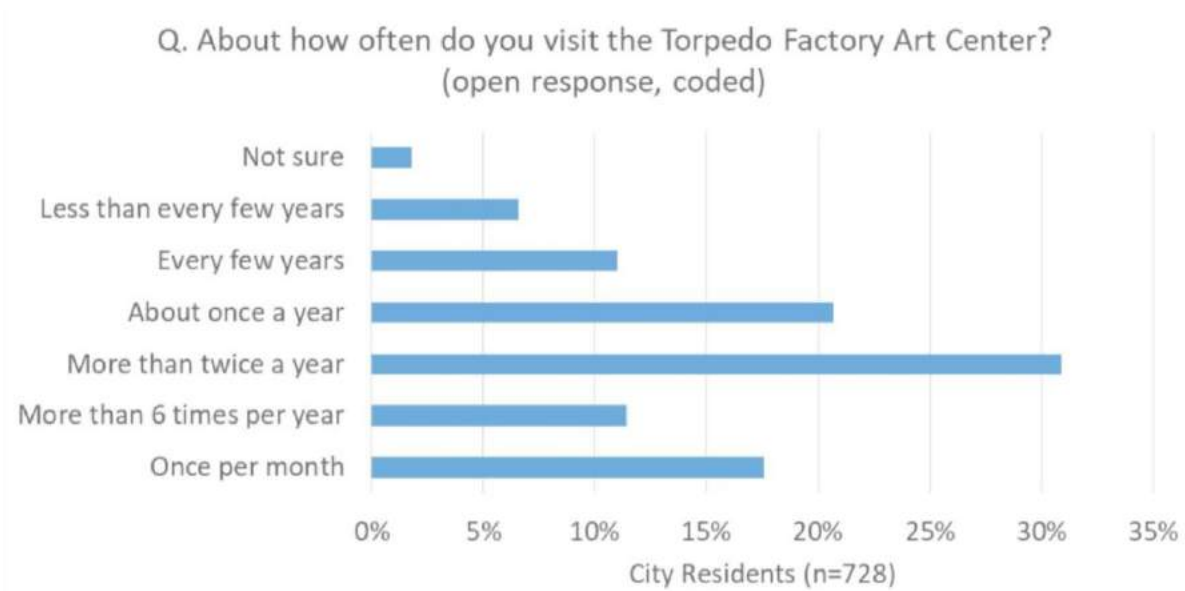

Chart 6. Frequency of Visits to Torpedo Factory Art Center



Respondents unfamiliar with the Torpedo Factory Art Center were automatically directed to a series of questions about visits to the Waterfront rather than questions specific to their experience with TFAC. Therefore, results to TFAC-specific questions only reflect opinion of individuals familiar with the facility.

Chart 7. Frequency of Visits to Torpedo Factory Art Center by Affiliation with The Art League

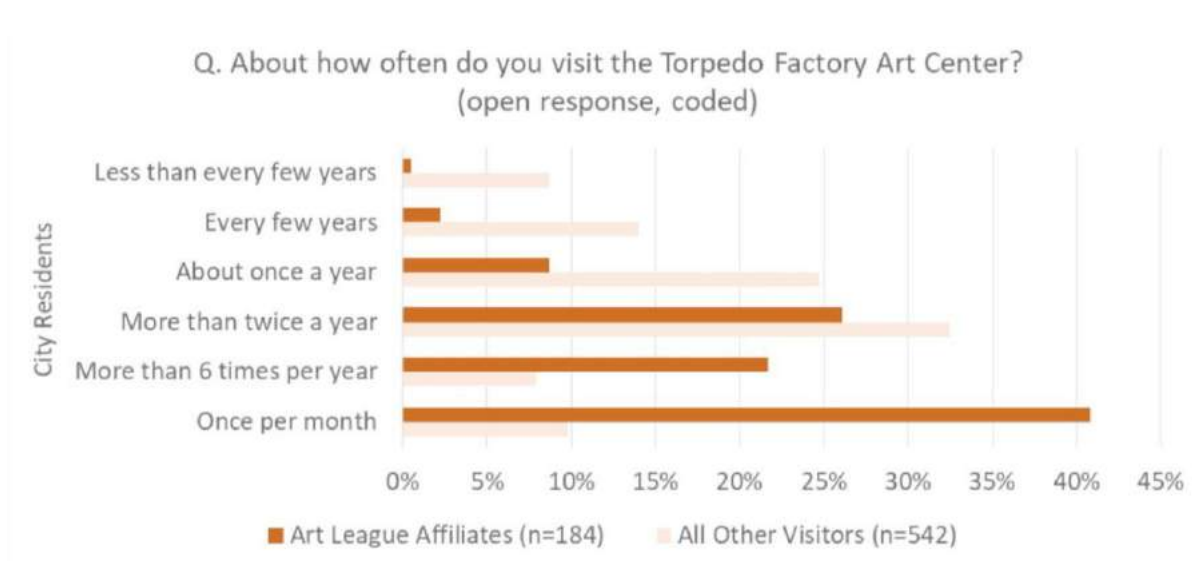

Chart 8. Frequency of Visits to Torpedo Factory by Respondent Age Groups

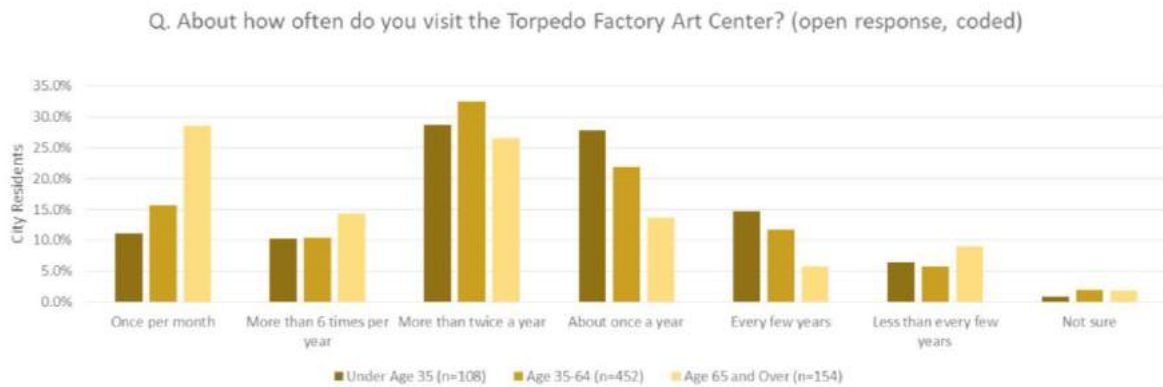

Chart 9. Respondent ZIP Codes by Frequency of Visits* to Torpedo Factory Art Center

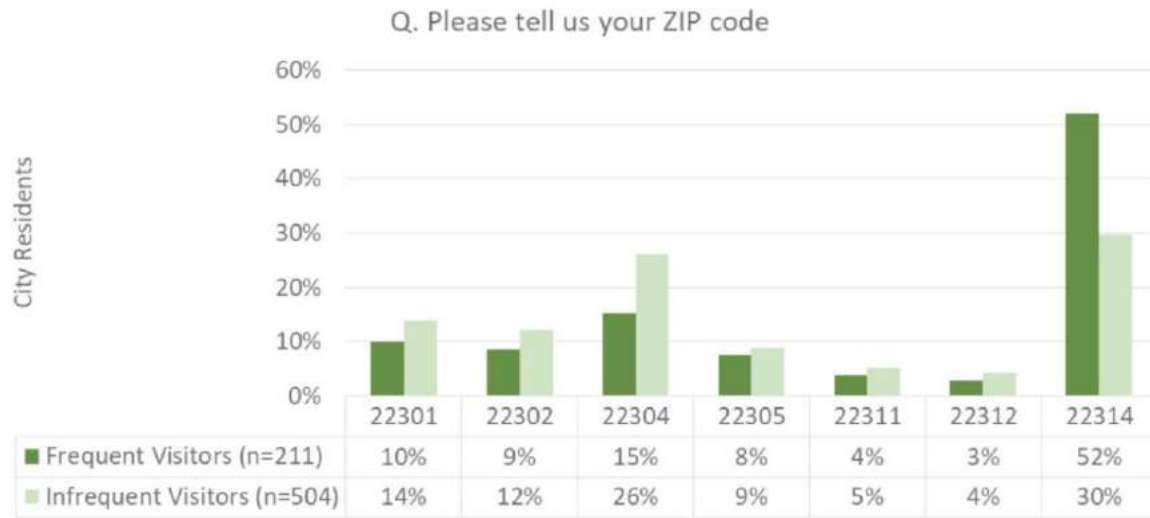
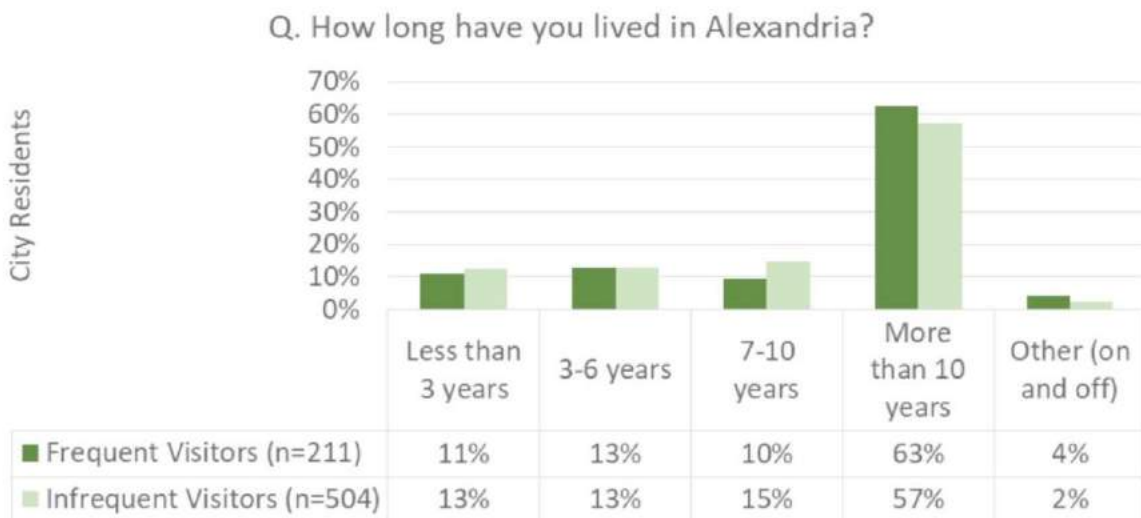

Chart 10. Respondent Length of City Residence by Frequency of Visits to Torpedo Factory Art Center



For the purposes of segmentation, frequent visitors is defined as a group of respondents who reported visiting the Torpedo Factory Art Center once per month or more often. Infrequent visitors is defined as a group of respondents who reported visiting the Torpedo Factory Art Center less often than once per month.

Chart 11. Respondent Age by Frequency of Visits to Torpedo Factory Art Center

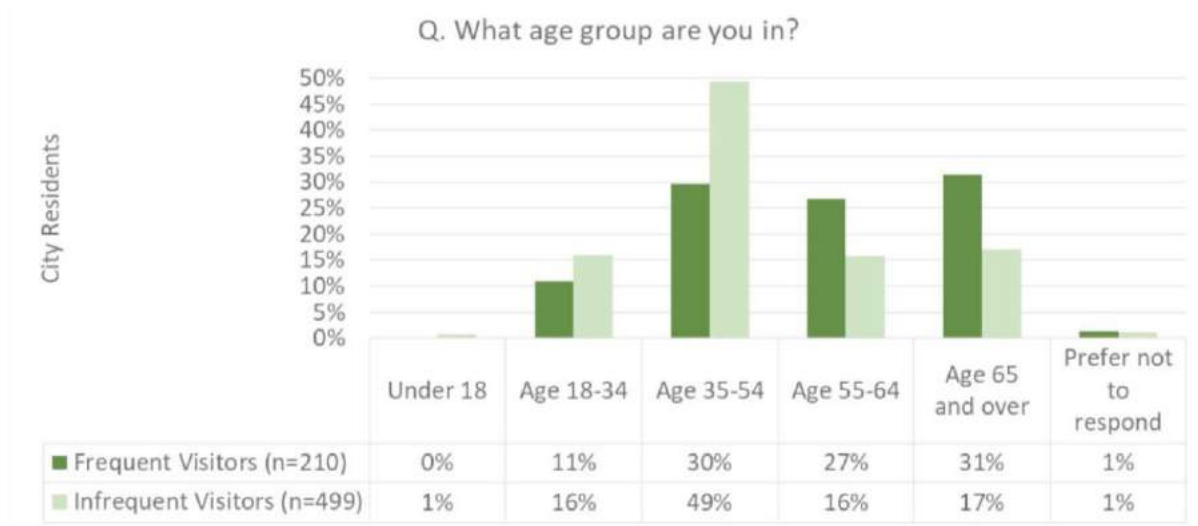

Chart 12. Respondent Age by Affiliation with The Art League

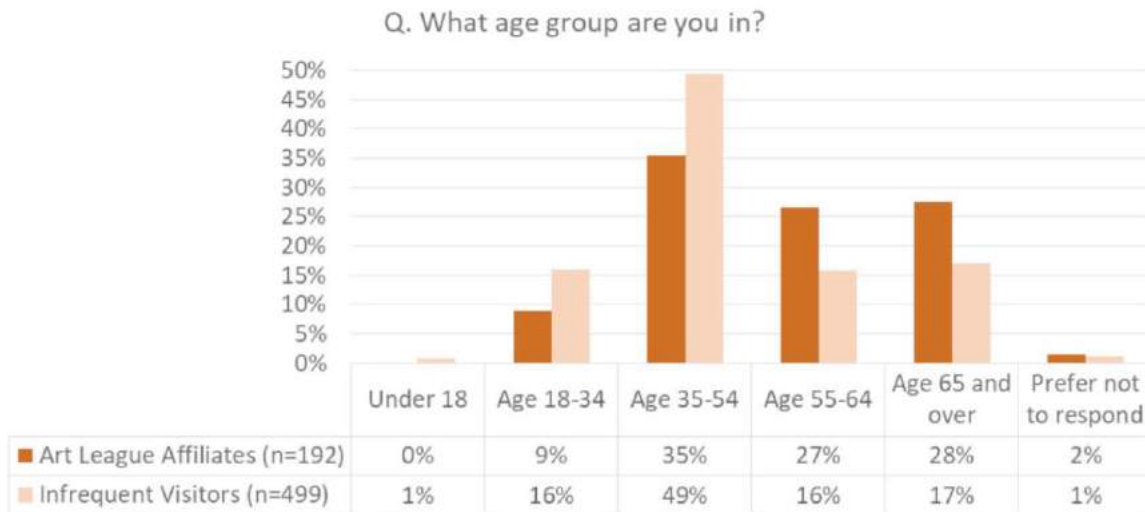

Chart 13. Respondent Visits to Other Art Venues

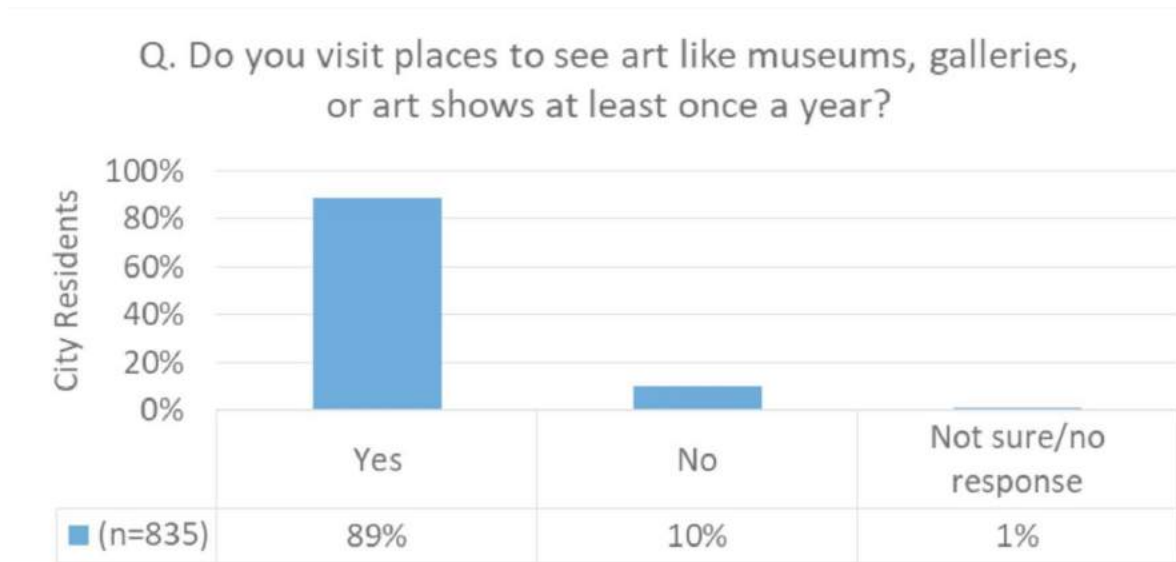

Chart 14. Respondent Visits to Other Art Venues by Frequency of Torpedo Factory Art Center Visits

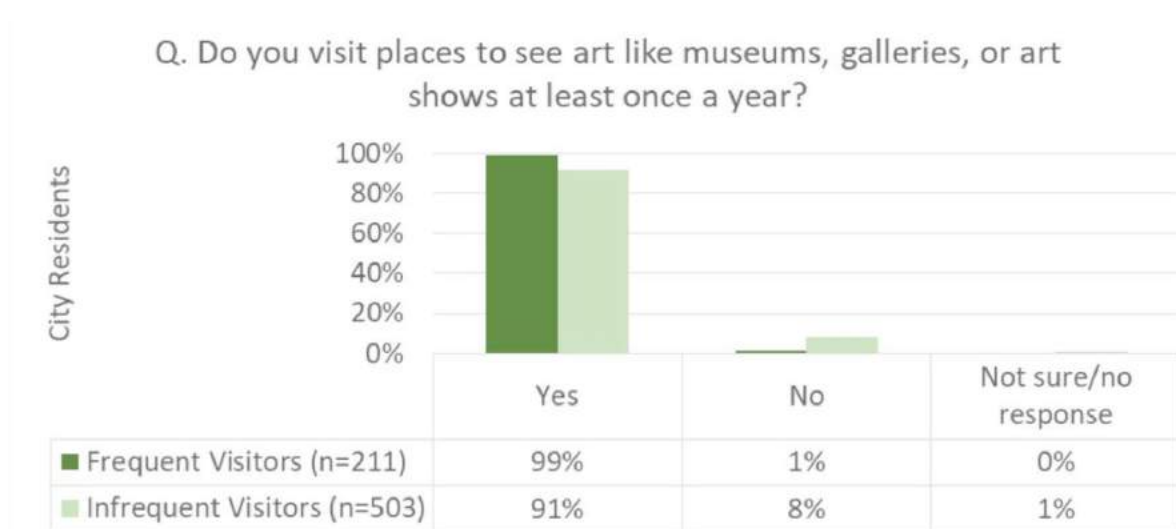

Chart 15. Respondent Visits to Other Art Venues by Affiliation with The Art League

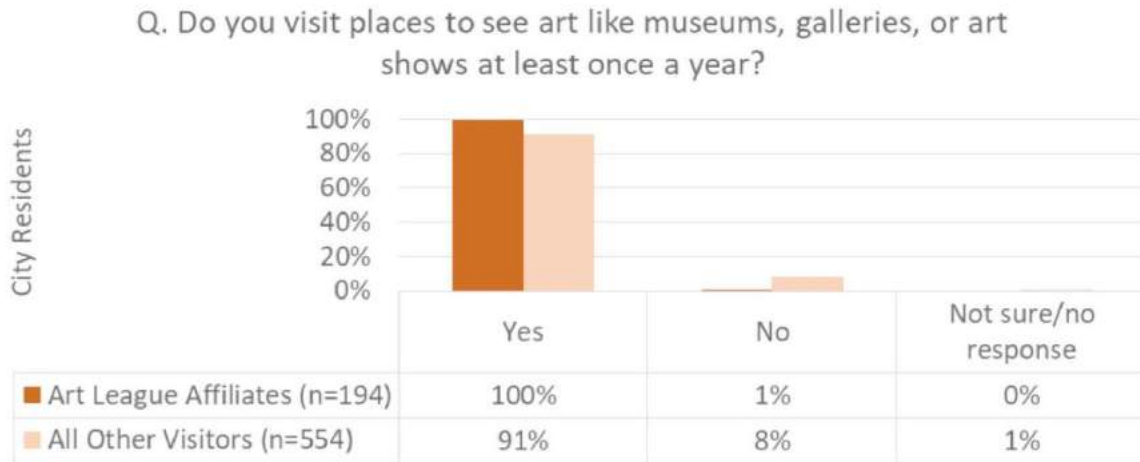

Chart 16. Respondent Reasons for Visiting Torpedo Factory Art Center

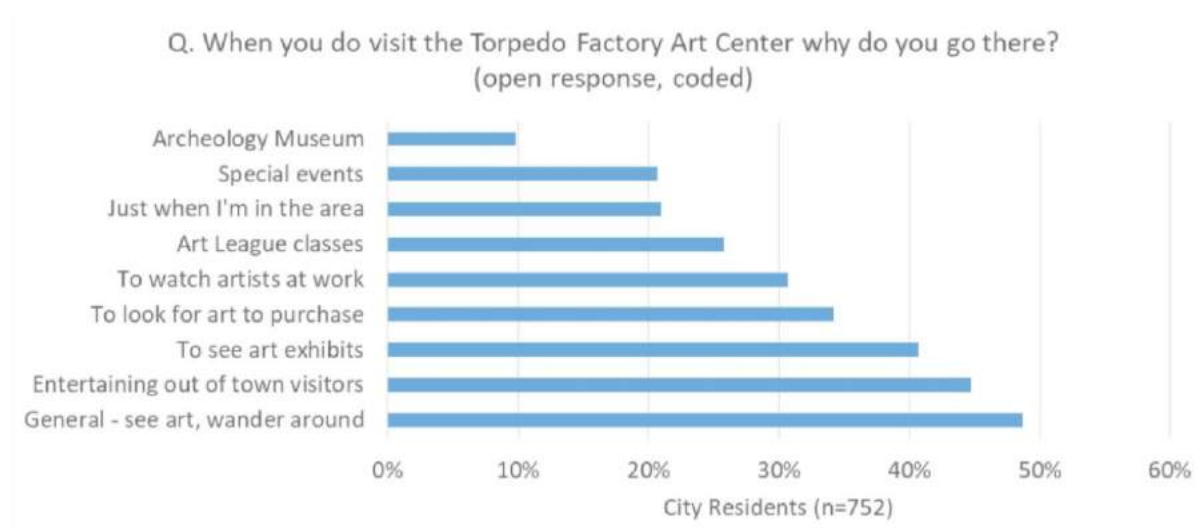

Chart 17. Respondent Reasons for Visiting Torpedo Factory Art Center by Affiliation with The Art League

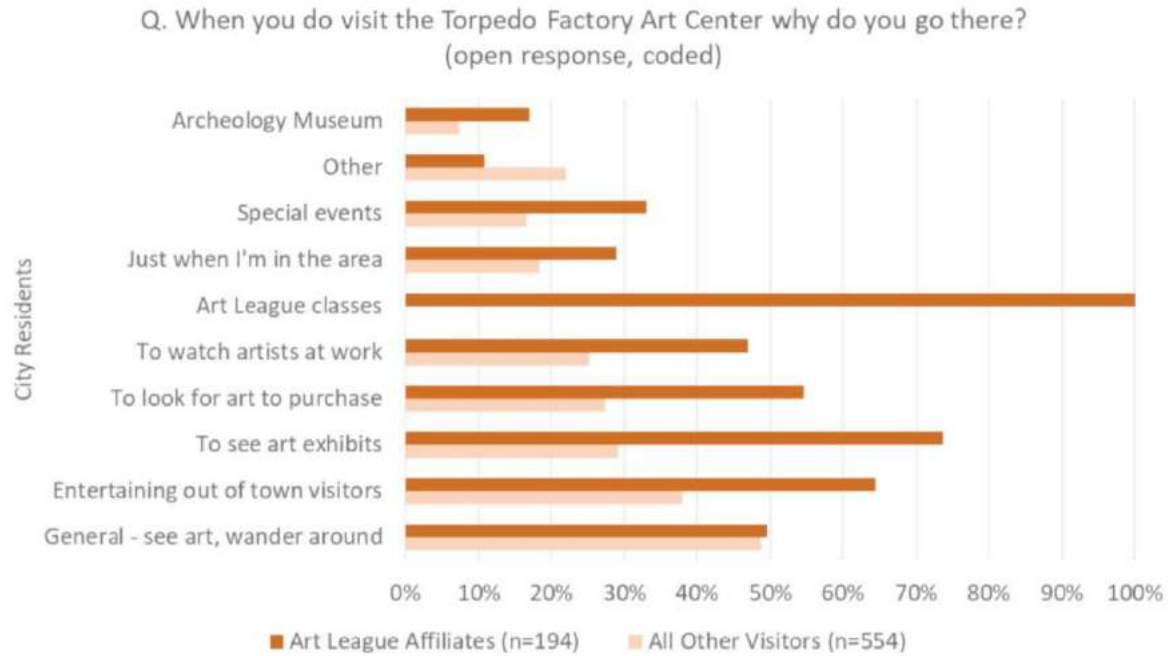

Chart 18. Reasons for Visiting Torpedo Factory Art Center by Respondent Age Groups

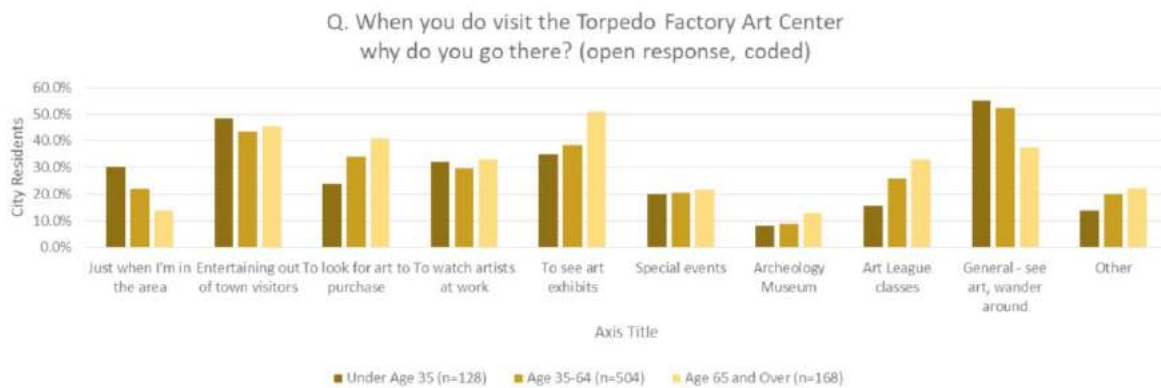

Chart 19. Torpedo Factory Art Center Importance to Alexandria's Identity

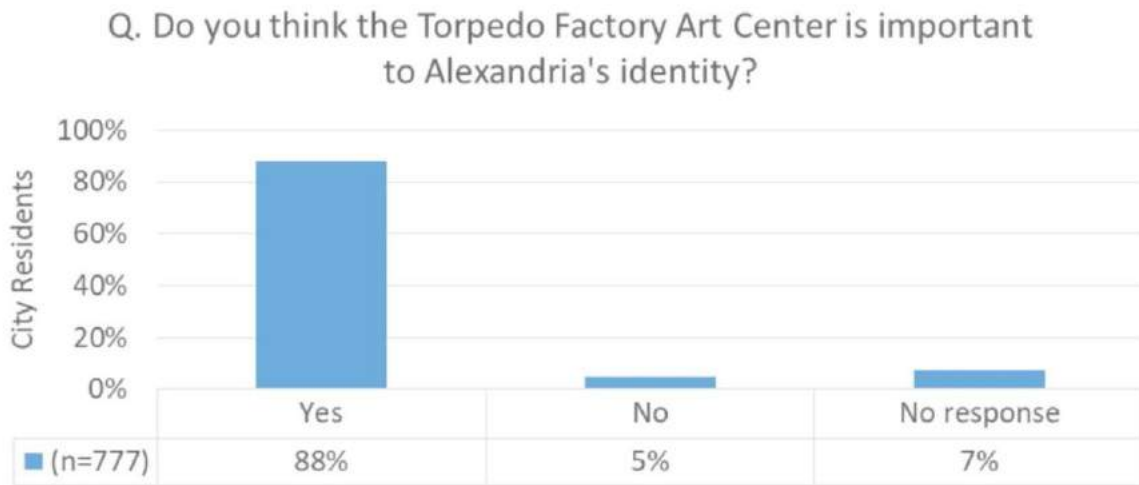

Chart 20. Torpedo Factory Art Center Importance to Alexandria's Identity by Affiliation with The Art League

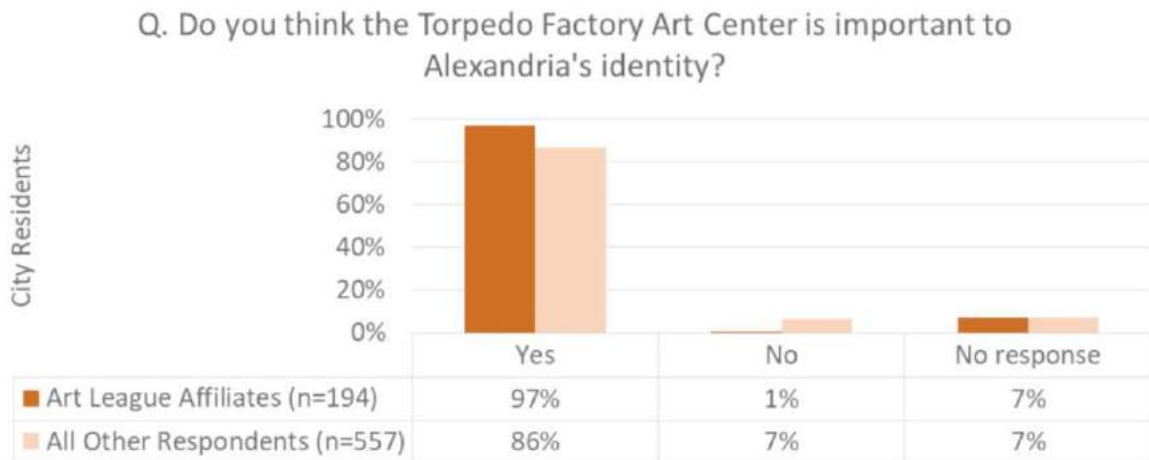

Chart 21. Why Torpedo Factory Art Center Is Important to Alexandria’s Identity

This question was asked of respondents who indicated that the Torpedo Factory Art Center is important to Alexandria’s Identity.

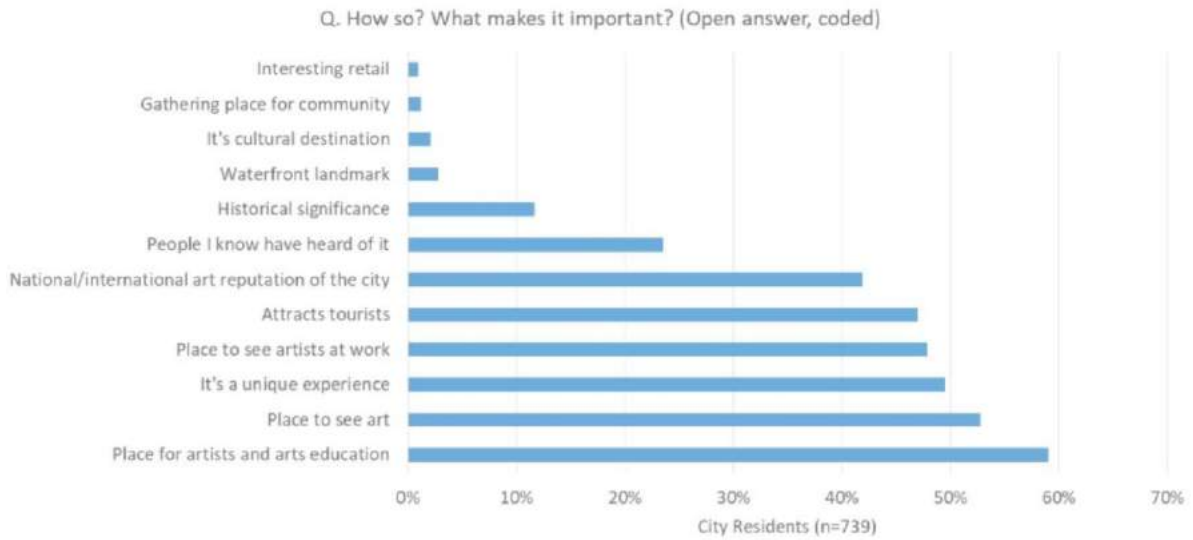

Chart 22. Why Torpedo Factory Art Center Is Important to Alexandria’s Identity by Affiliation with The Art League

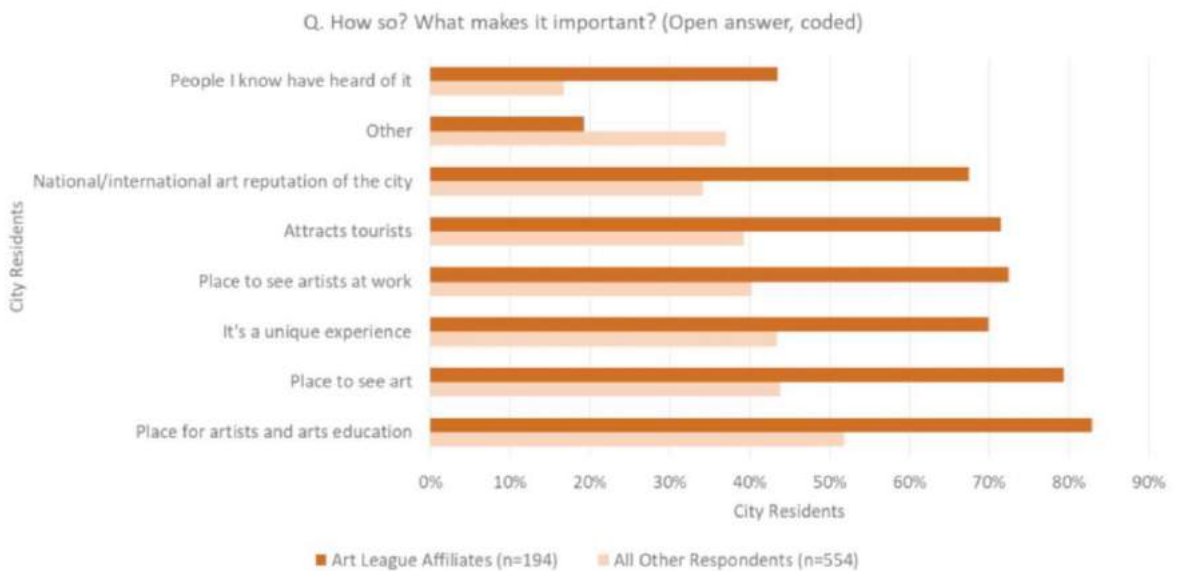

Chart 23. Respondent Feelings about City Support of Artists through Discounted Rates at Torpedo Factory Art Center

This question was asked of respondents familiar with the Torpedo Factory Art Center regardless of whether or not they indicated having visited the facility.

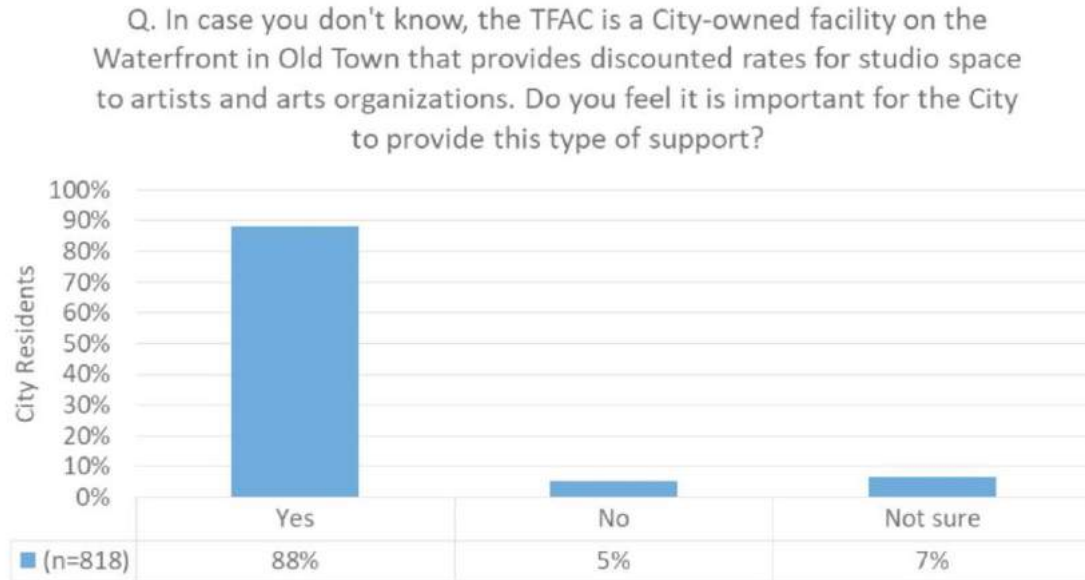

Chart 24. Respondent Feelings about City Support of Artists through Discounted Rates at Torpedo Factory Art Center by Affiliation with The Art League

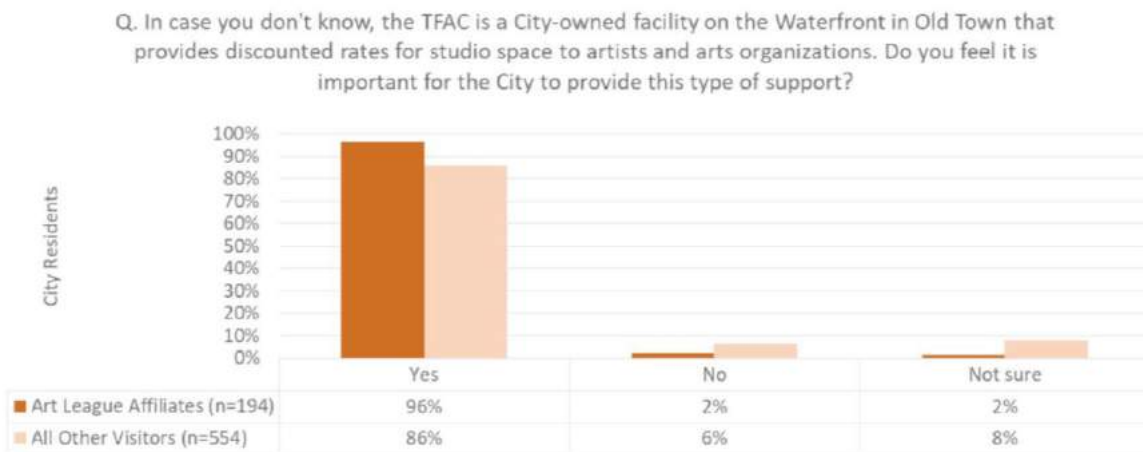

Chart 25. Respondent Feelings about Access to Discounted Space Rates at Torpedo Factory Art Center and Status of Artist Residency

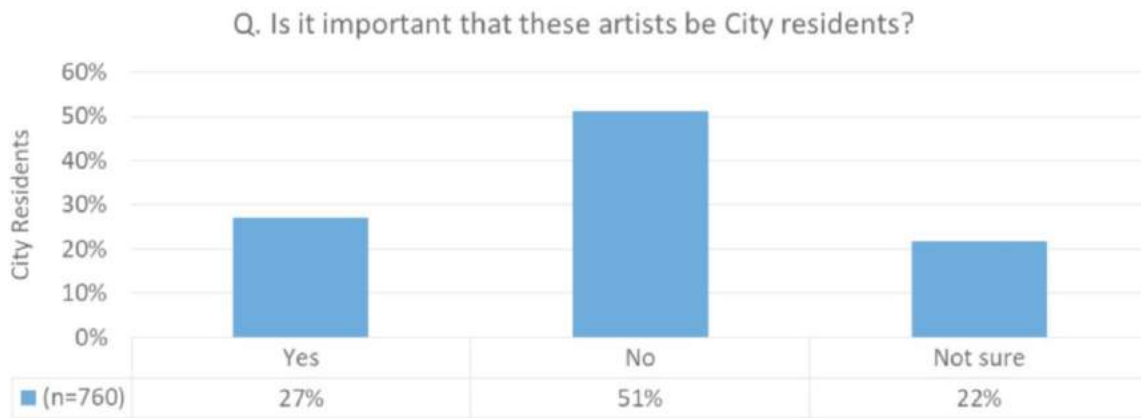

Chart 26. Respondent Feelings about Access to Discounted Space Rates at Torpedo Factory Art Center and Status of Artist Residency by Affiliation with The Art League

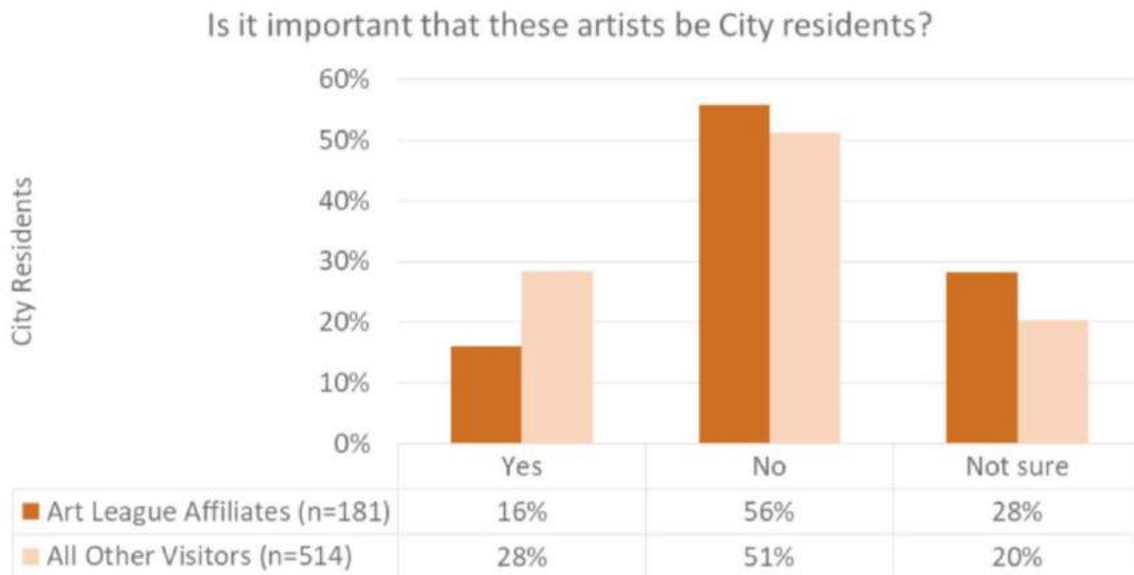

Chart 27. Respondents' Most Recent Visit to Torpedo Factory Art Center

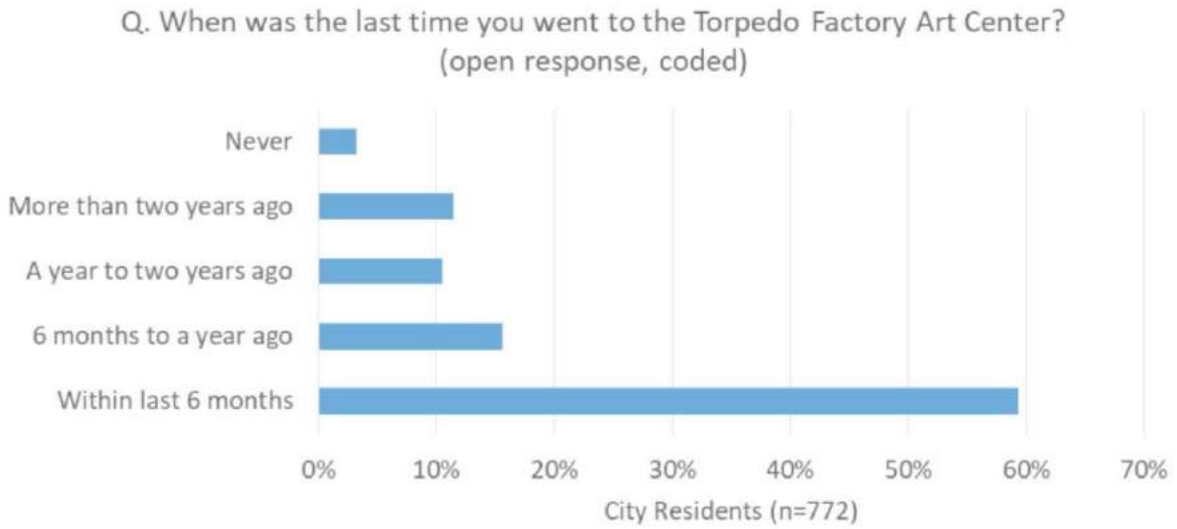

Chart 28. Respondents' Most Recent Visit to Torpedo Factory Art Center by Affiliation with The Art League

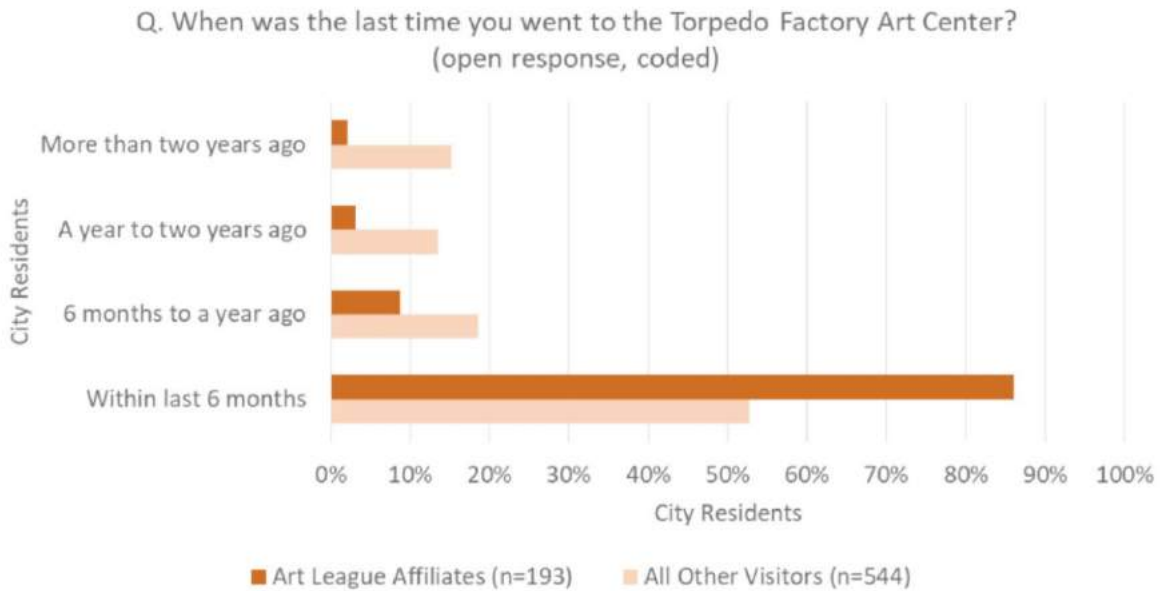

Chart 29. Most Recent Visit to Torpedo Factory Art Center by Respondent Age Group

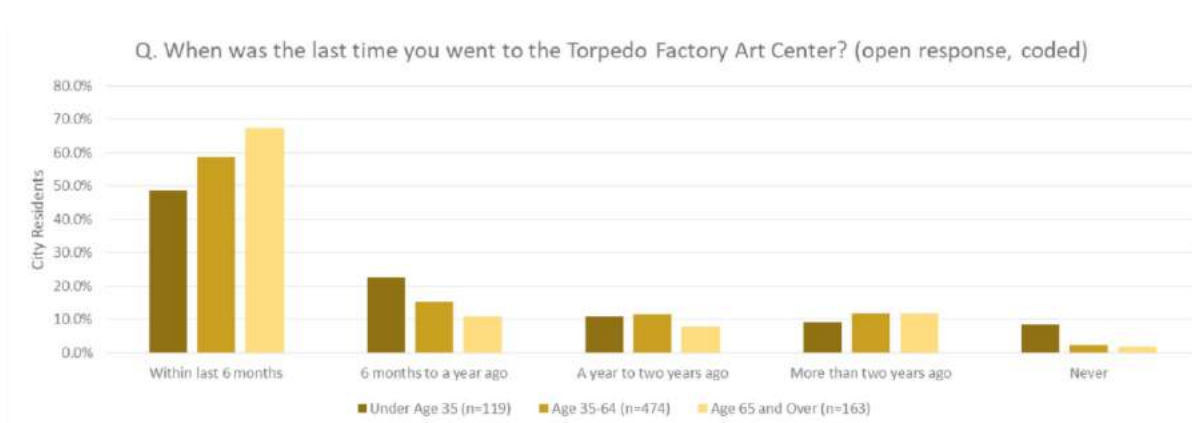

Chart 30. Convenient Times for Visiting Torpedo Factory Art Center for Respondents Familiar with Torpedo Factory Art Center

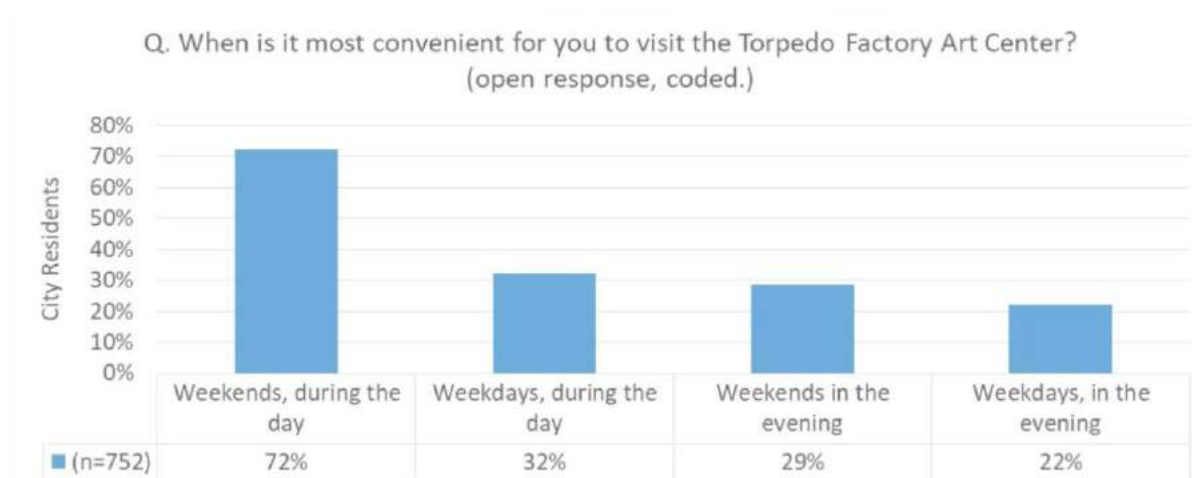

Chart 31. Convenient Times for Visiting Torpedo Factory Art Center by Affiliation with The Art League

Questions regarding direct experience were only asked of respondents who indicated that they had visited the Torpedo Factory Art Center.

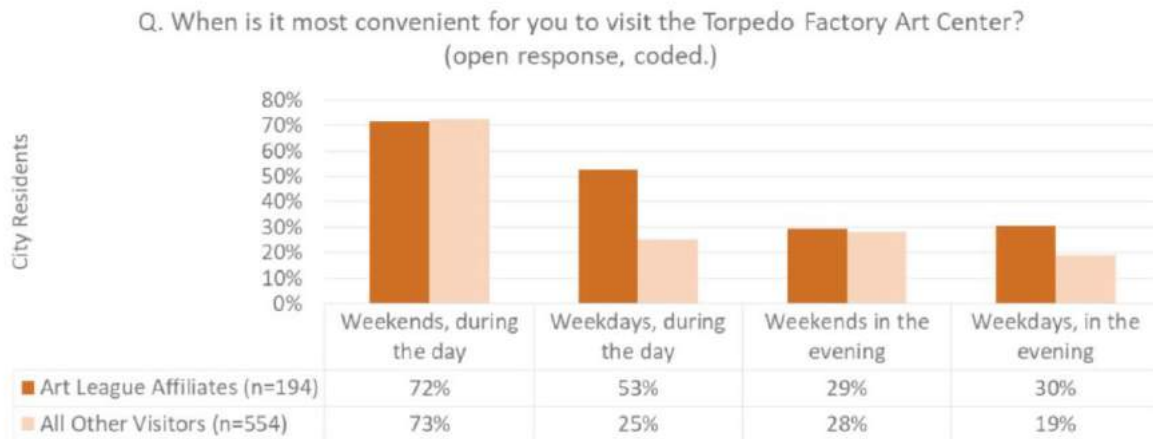

Chart 32. Respondent Satisfaction with Last Visit to Torpedo Factory Art Center

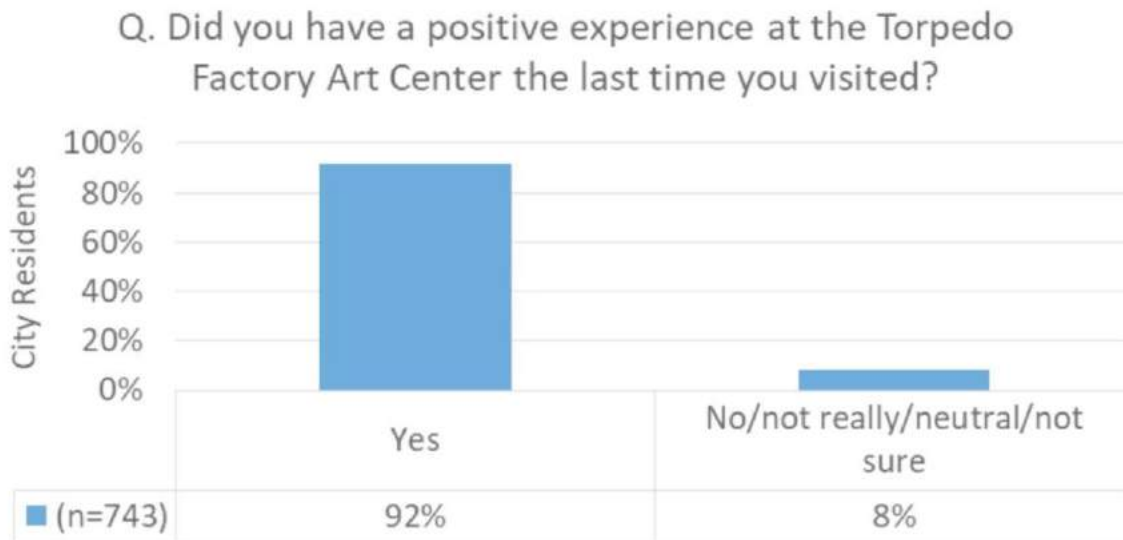

Chart 33. Respondent Satisfaction with Last Visit to Torpedo Factory Art Center by Affiliation with The Art League



Results are shown for percentages over 2%. One percent or fewer respondents mentioned the other following reasons: seeing art, talking to artists in studios, supports local artists, open and free to public, variety of shops, special events, family days/children’s activities, The Art League, convenience, open space of first floor, supports artists in general, restaurants in the area, lectures/performances, waterfront access, seeing what’s new, restrooms, layout of building, dog friendly, ability to apply for shows, variety of activities, the name, demonstrations, quiet, people watching, makes Alexandria stand out, quality of art work.

Chart 34. What Respondents Like Most About Torpedo Factory Art Center

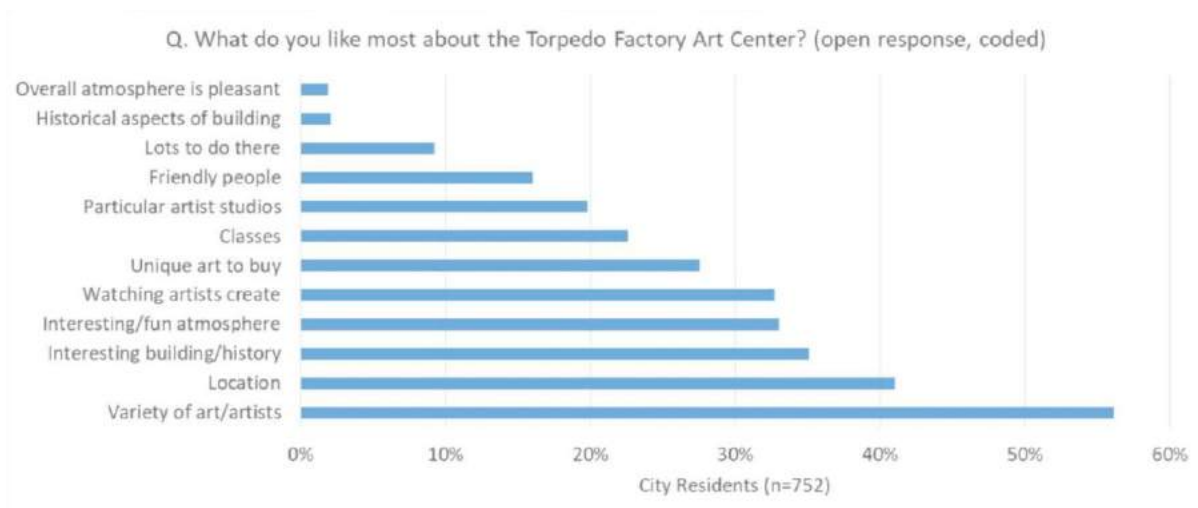

Chart 35. What Respondents Like Most About Torpedo Factory Art Center by Affiliation with The Art League

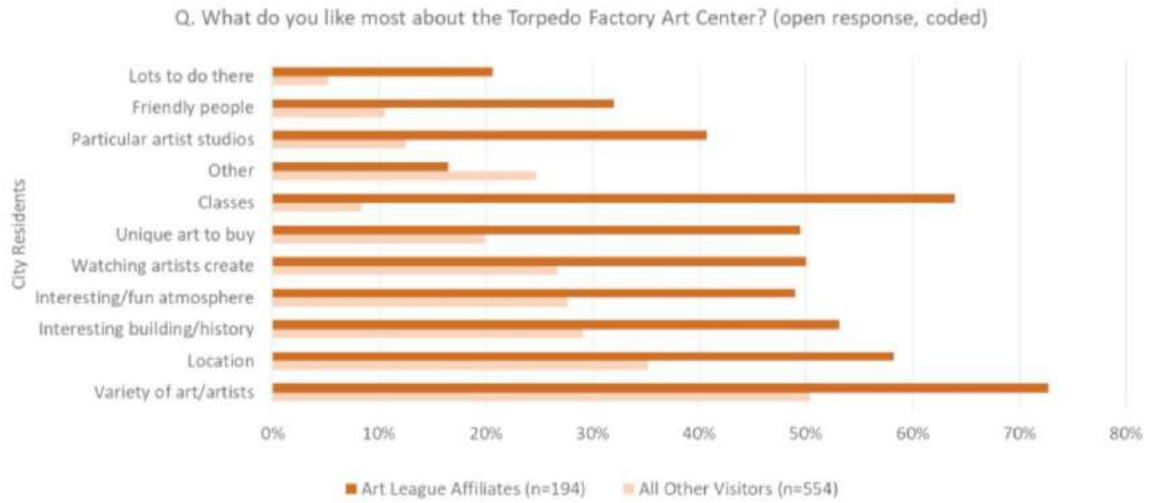

Chart 36. What Respondents Like Most About Torpedo Factory Art Center by Age Group

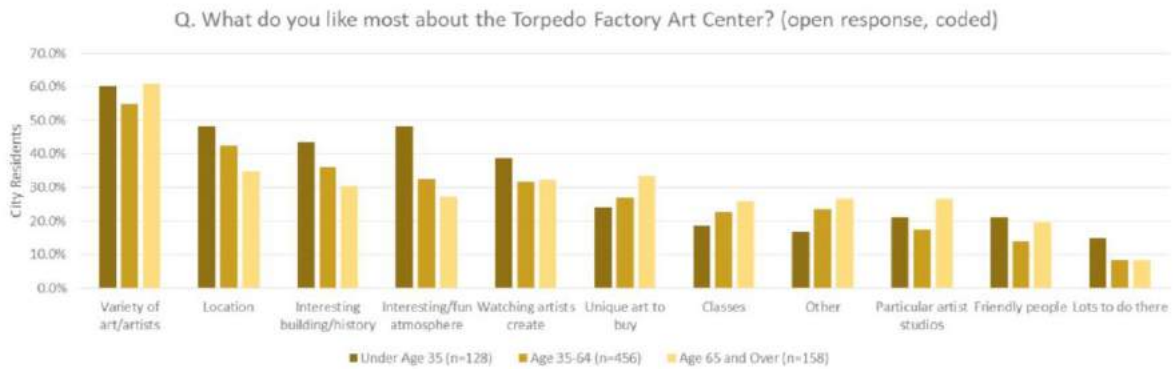
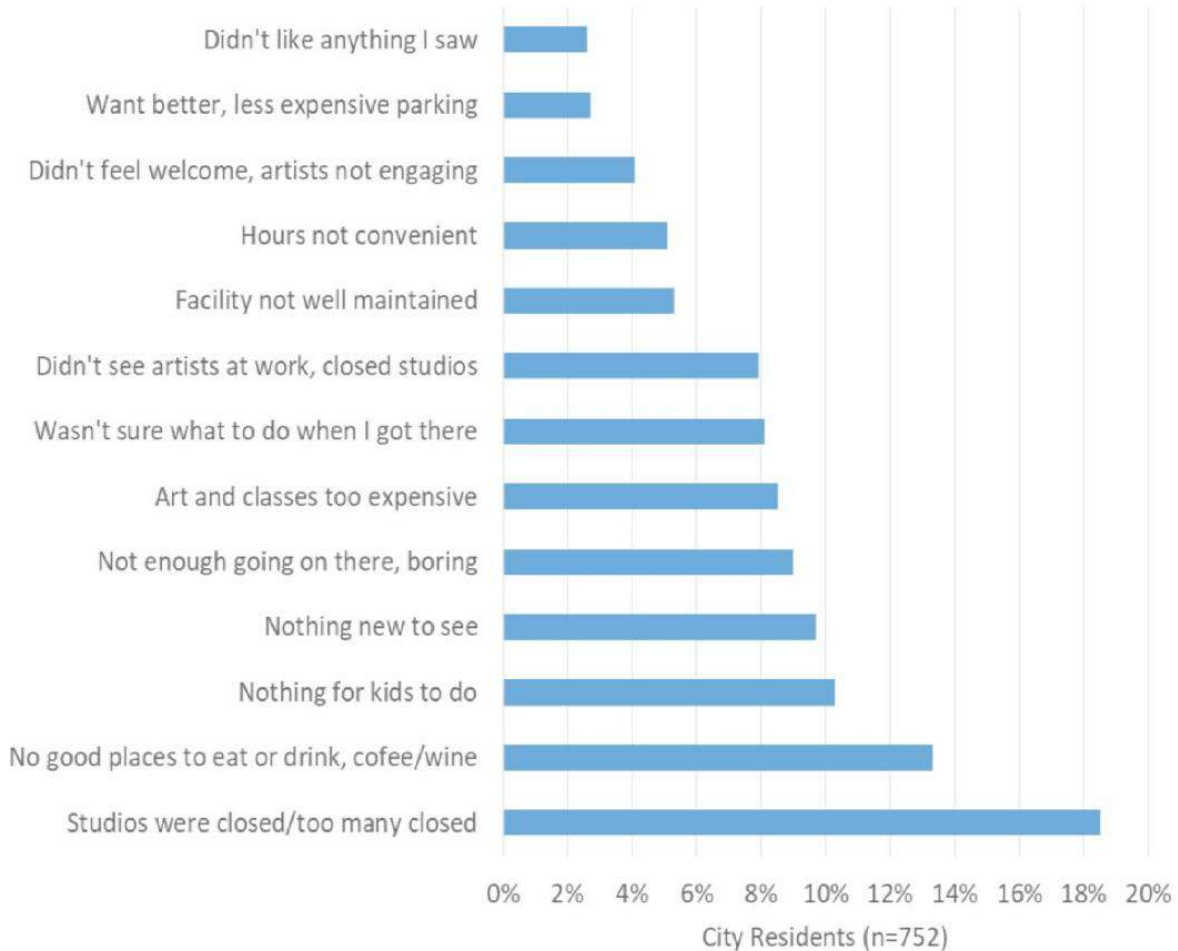

Chart 37. What Respondents Felt Did Not Meet Expectations at Torpedo Factory Art Center

Q. In what ways did the Torpedo Factory Art Center fall short of your expectations? Was there something specific that would have made your visit better?

(open response, coded)



Results are shown for percentages over 2%. One percent or fewer respondents mentioned the other following reasons: want facility upgrades, want area for children, want newer artists/art, want lower priced art/classes, location inconvenient, want better wayfinding, want real restaurant/wine/roof bar, want improved restrooms, was boring/empty, want more history, want more vendors, want coffee bar, building is ugly/dirty, want more interactive/social activities, want more variety of art, want later hours, want more advertising, doesn't reflect Alexandria's demographics, tacky/commercial, want more seating, want it more open to community, anti-Trump signs offensive, want live entertainment/film, handicapped access, didn't care for the art, no large gift shop, artists complaining about management, want better flow, want better art store, want artist made souvenirs, more public programs, more private classes, want packages, not told about tours, want more for young adults, want special art sales, no clear identity, should be pet free, want more local art.

Chart 38. What Respondents Felt Did Not Meet Expectations at Torpedo Factory Art Center by Affiliation with The Art League

Q. In what ways did the Torpedo Factory Art Center fall short of your expectations? Was there something specific that would have made your visit better?
(open response, coded)

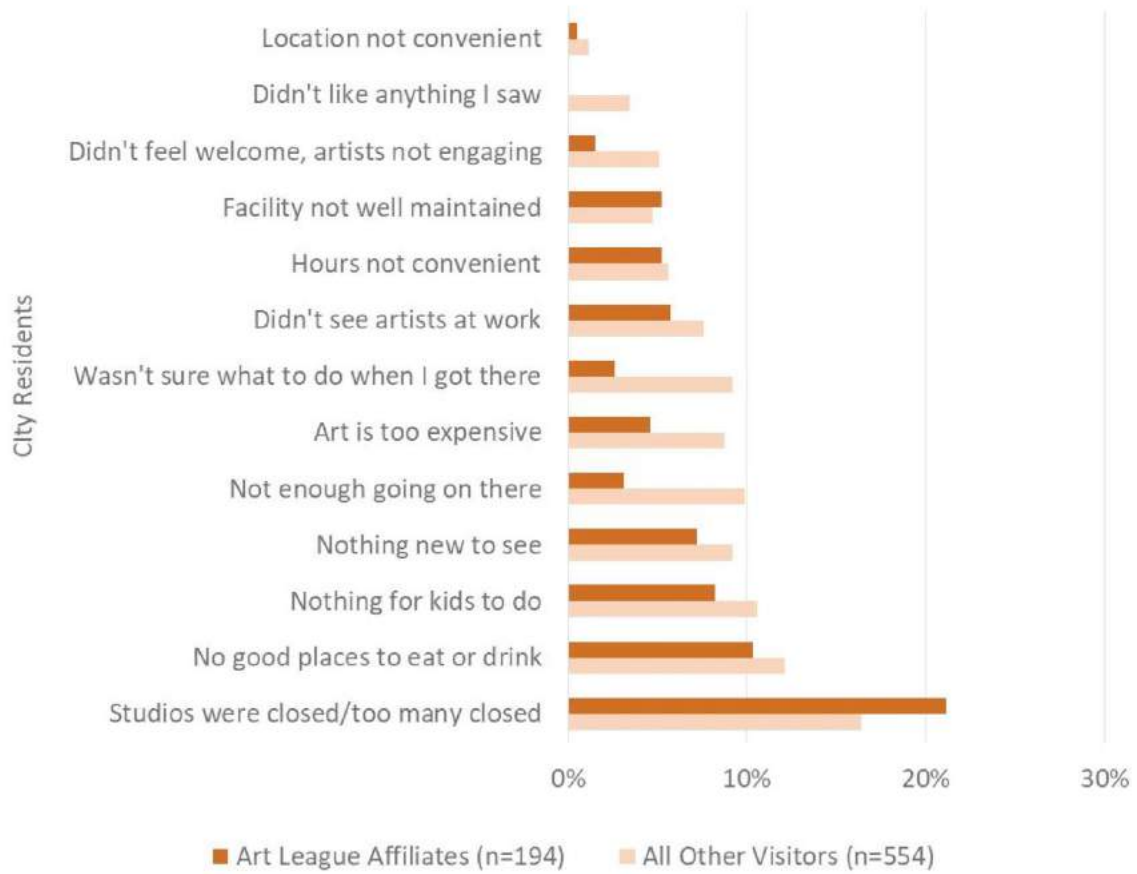
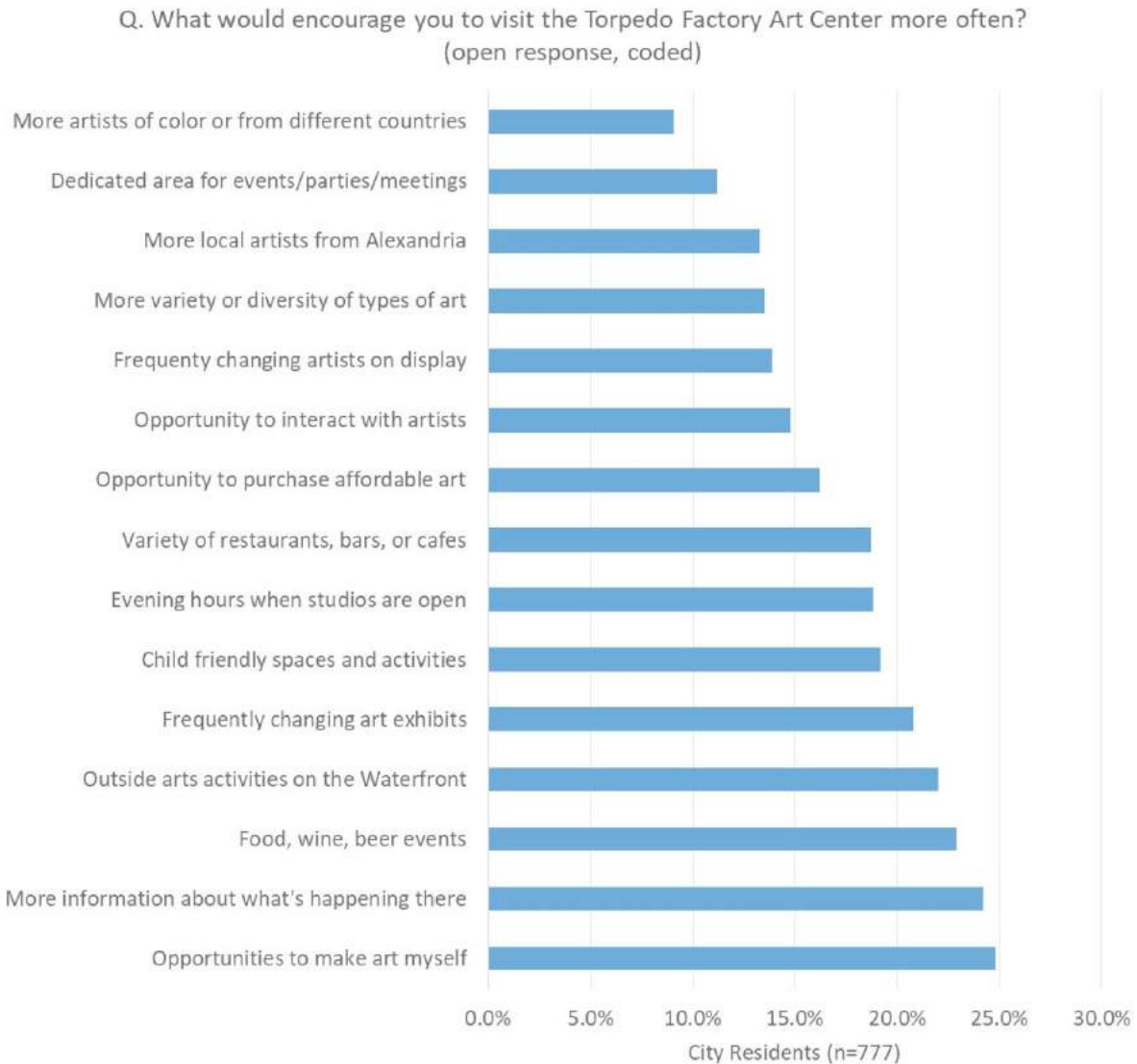

Chart 39. What Would Encourage Respondents to Visit Torpedo Factory Art Center More Often



Results are shown for percentages over 5%. Five percent or fewer respondents mentioned the other following reasons (that were not in direct response to what was mentioned in their statement of short falls, i.e. poor wayfinding/better wayfinding or closed studios/open studios): better parking, consistent studio open hours, no kids allowed, craft fair/farmer's market atmosphere, walking around with wine, better management, maker space, museum collection, major artists in residence, major exhibitions, coupons/raffles/door prizes, opportunities for emerging artists, physical programs/yoga, open daily, more artists, better community outreach, online catalog.

Chart 40. What Would Encourage Respondents to Visit Torpedo Factory Art Center More Often by Affiliation with The Art League

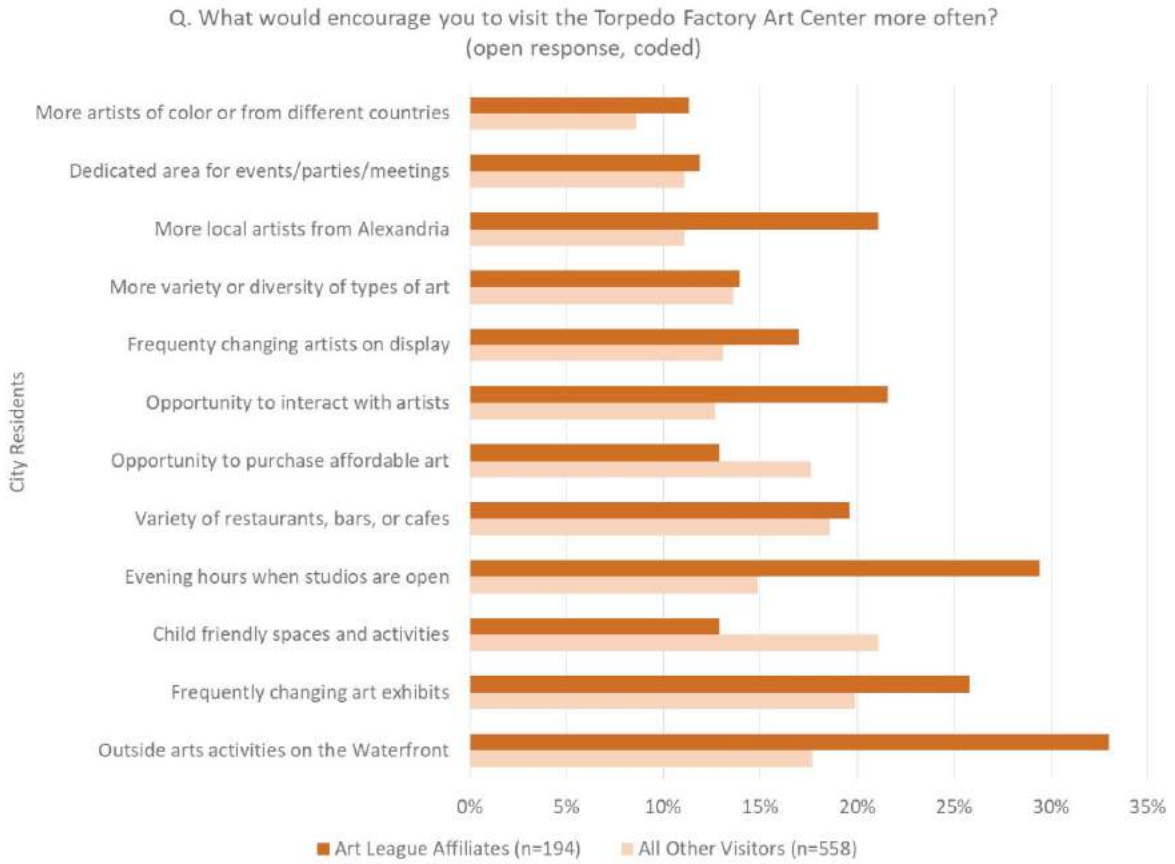
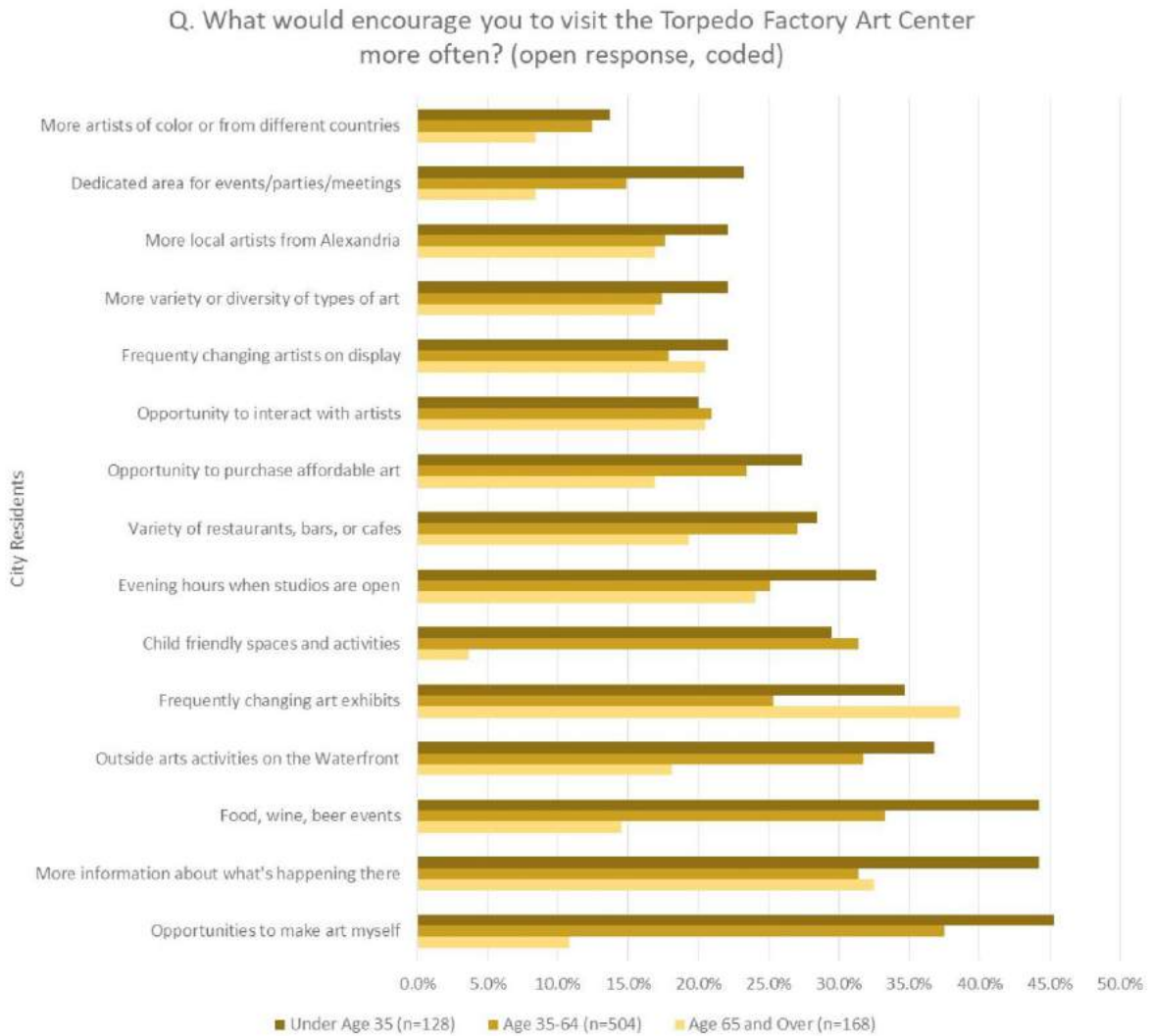

Chart 41. What Would Encourage Respondents to Visit Torpedo Factory Art Center More Often by Respondent Age Groups



RESPONDENTS UNFAMILIAR WITH THE TORPEDO FACTORY ART CENTER

Chart 42. Frequency of Visits to the Alexandria Waterfront

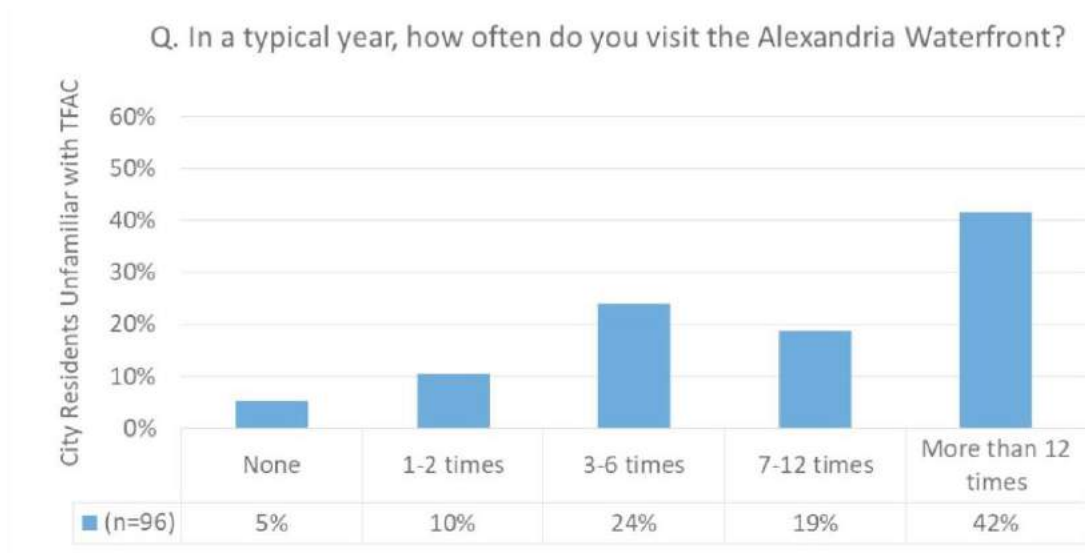

Chart 43. Interest in Waterfront Activities by Residents Unfamiliar with Torpedo Factory Art Center

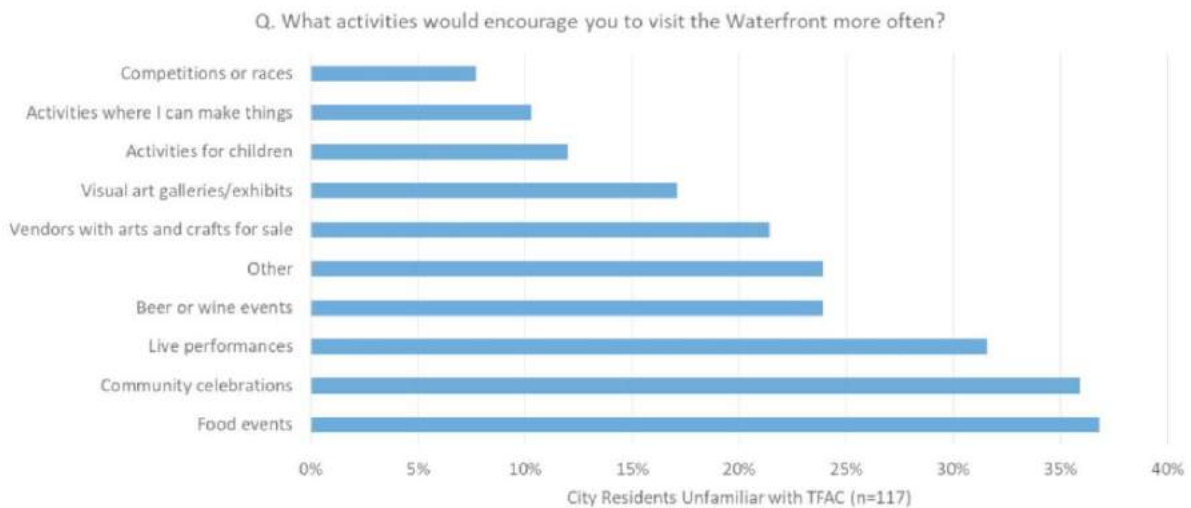
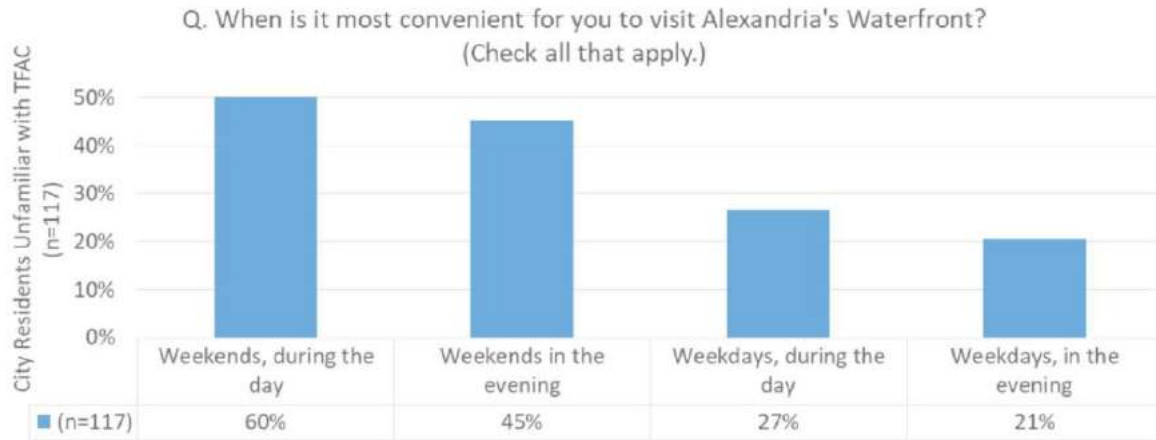

Chart 44. Convenient Times for Visiting Alexandria’s Waterfront for Residents Unfamiliar with Torpedo Factory Art Center



RESPONDENT CHARACTERISTICS

Chart 45. Respondent Age

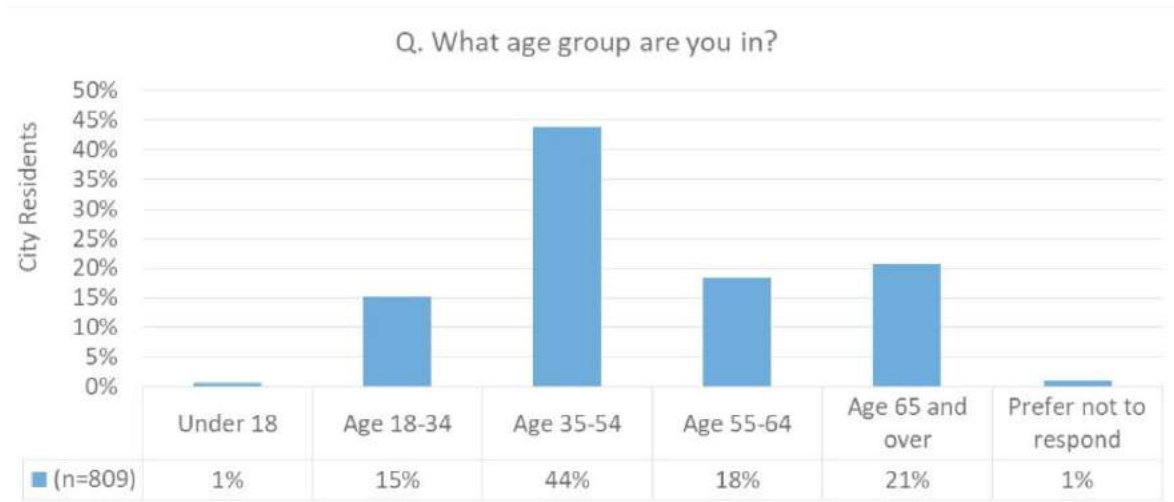

Chart 46. Respondent Age by Affiliation with The Art League

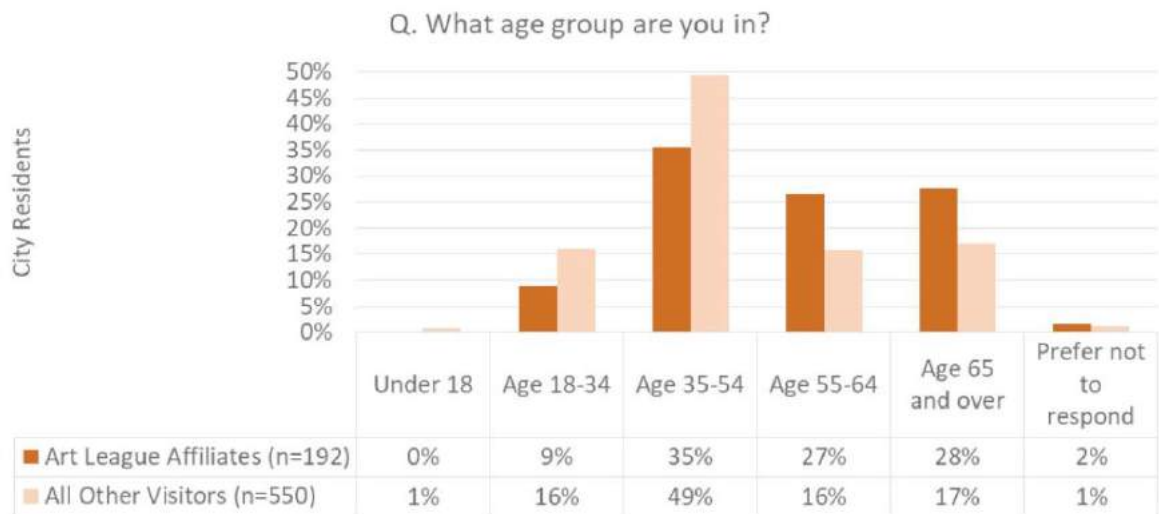

Chart 47. Respondent Householders by Age

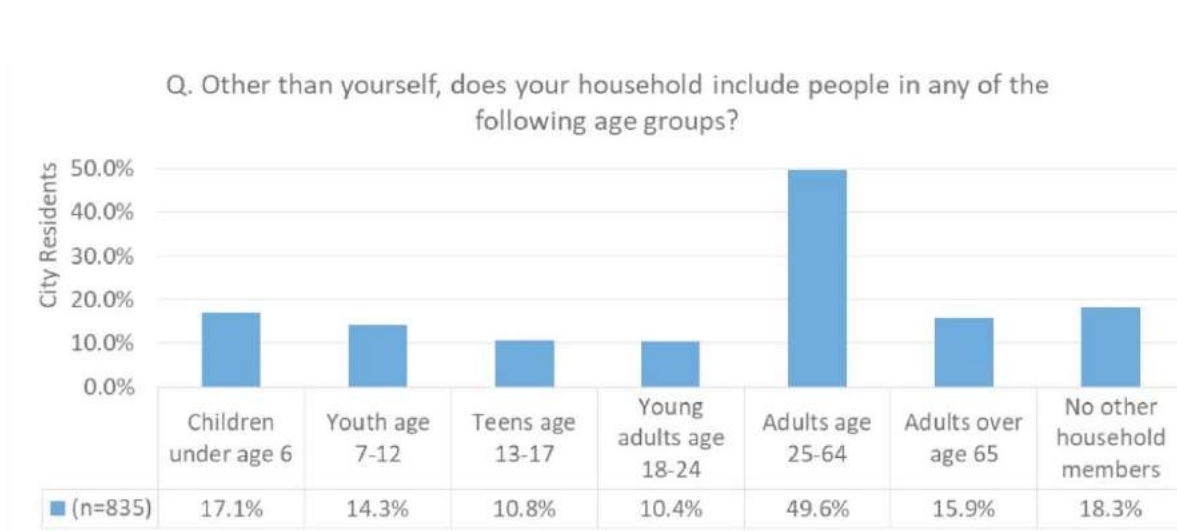
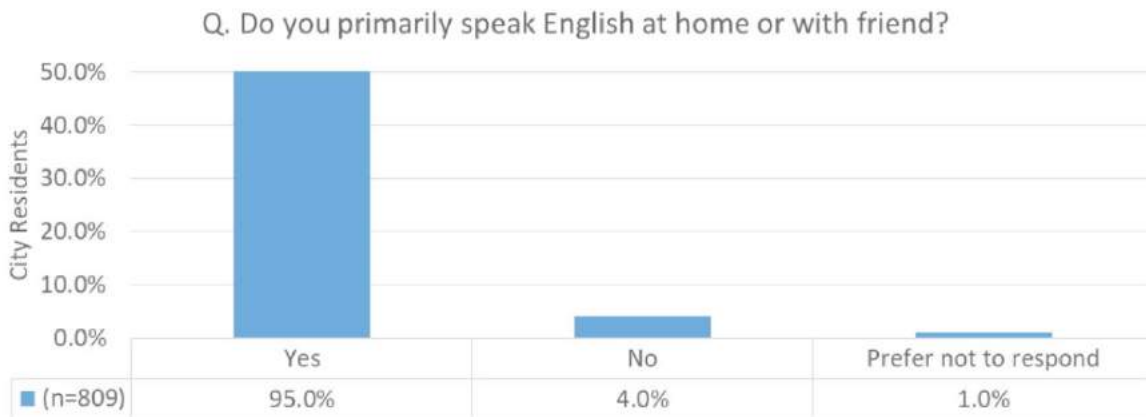

Chart 48. Respondent Languages Spoken at Home or with Friends



*Other languages spoken by respondents:
 Spanish (14), Amharic (10), French (2), Bengali (1), Hindi (1), Temne (1), Tigrinya (1), Twi - Ghana (1)*

ARTIST SURVEY RESULTS

Chart 49. Respondent ZIP code

A total of 1,117 artist surveys were received from 198 different ZIP codes, 341 of which were located within the Alexandria ZIP codes included in this study.

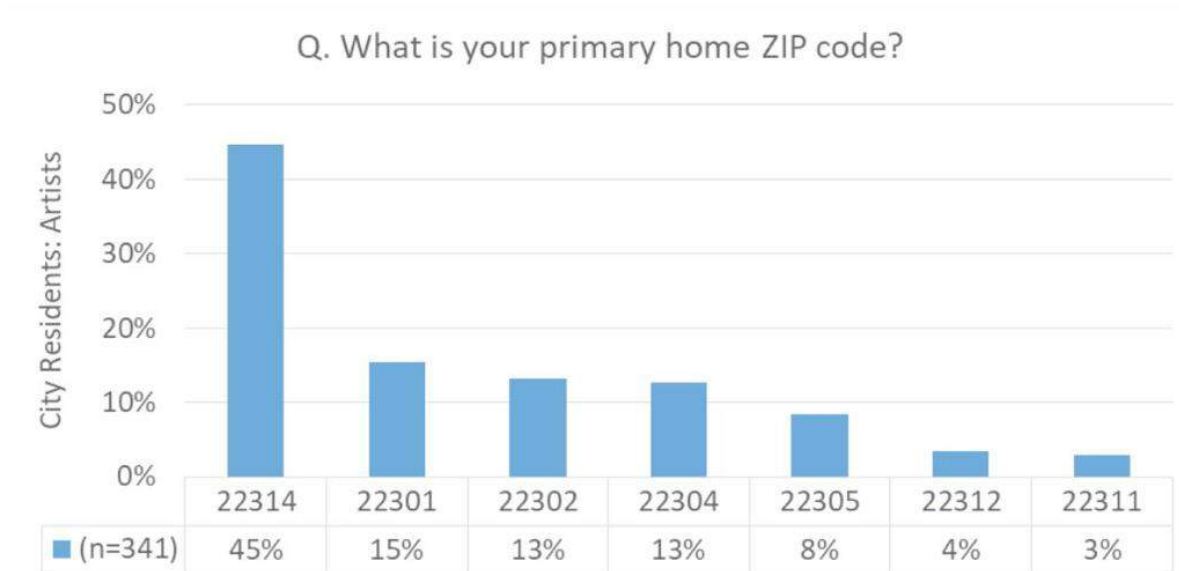

Chart 50. Survey Respondent Length of Residence in Alexandria

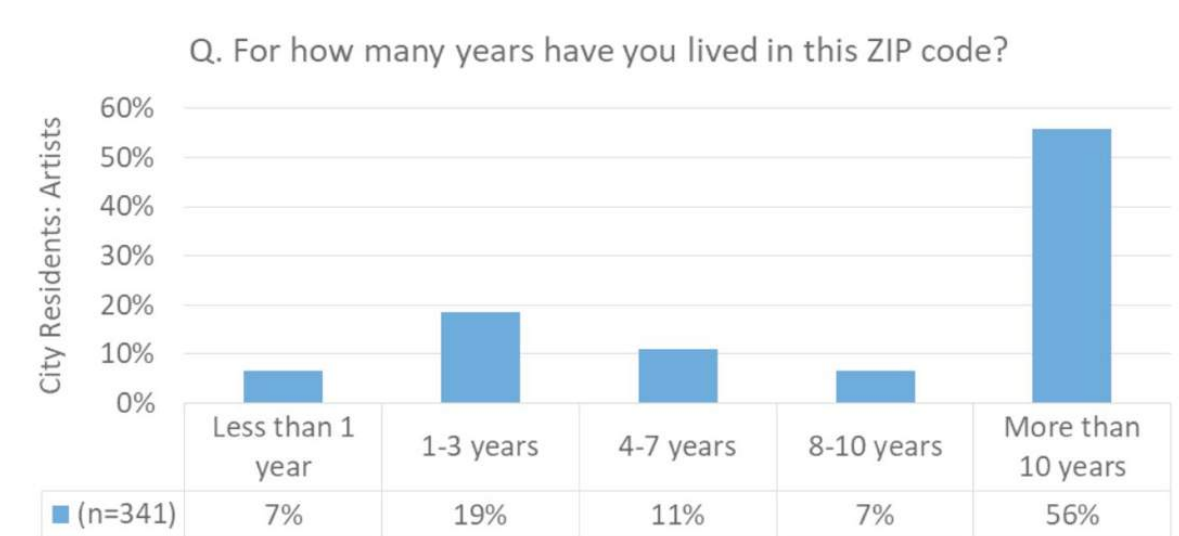

Chart 51. Professional Artists

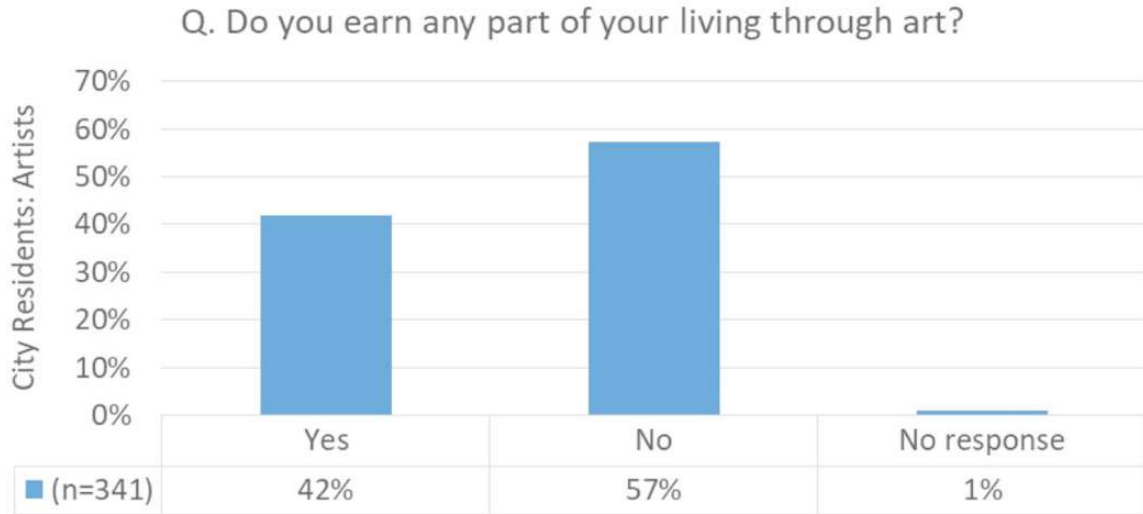

Chart 52. Annual Income Derived from Artistic Practice

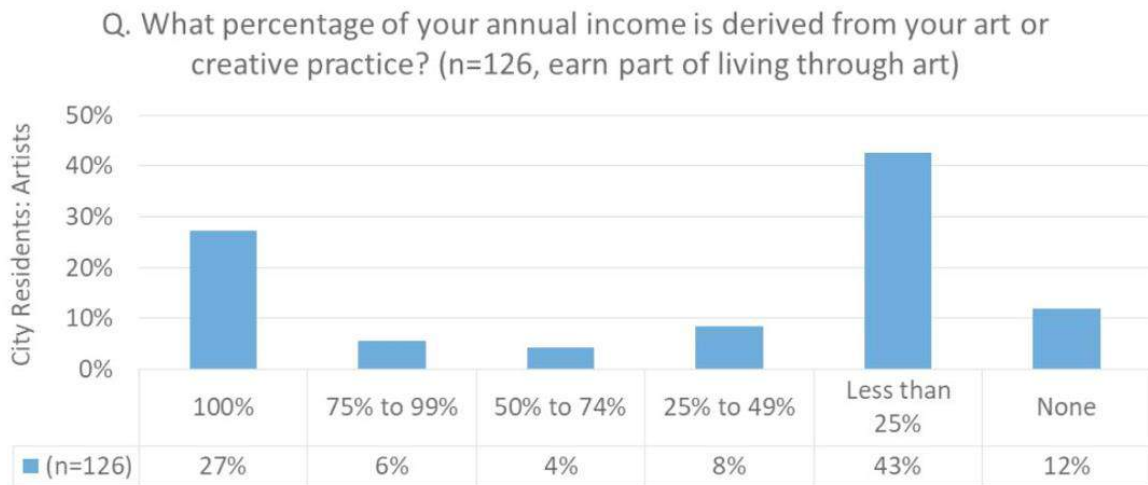

Chart 53. Professional Artists by Age Group

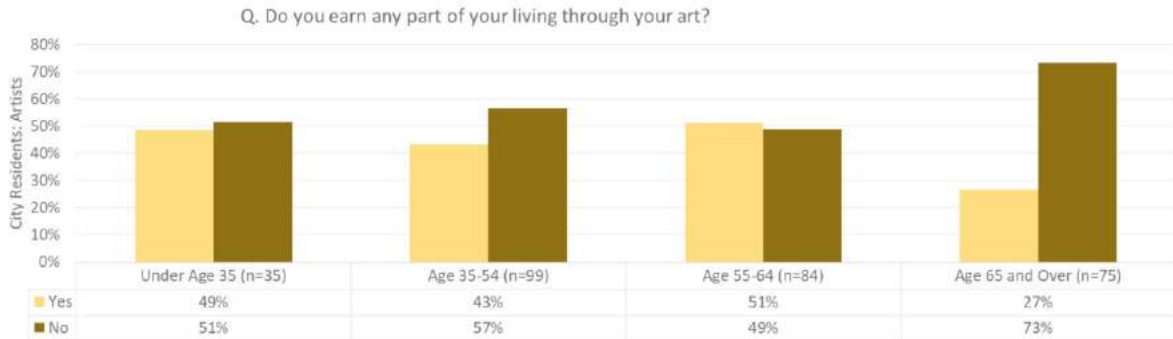

Chart 54. Respondent Familiarity with Torpedo Factory Art Center

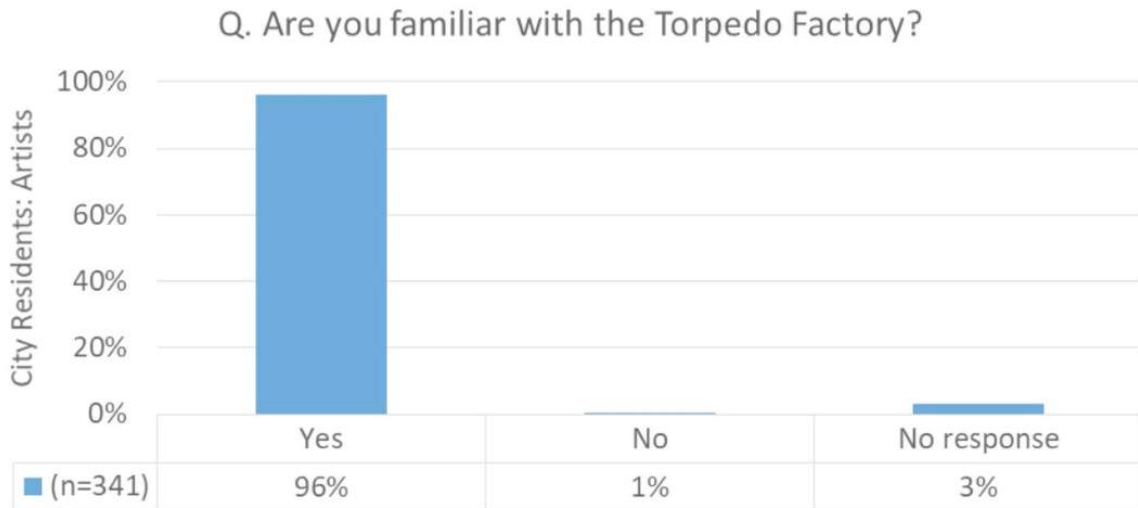

Chart 55. Torpedo Factory Art Center Importance to Alexandria's Identity

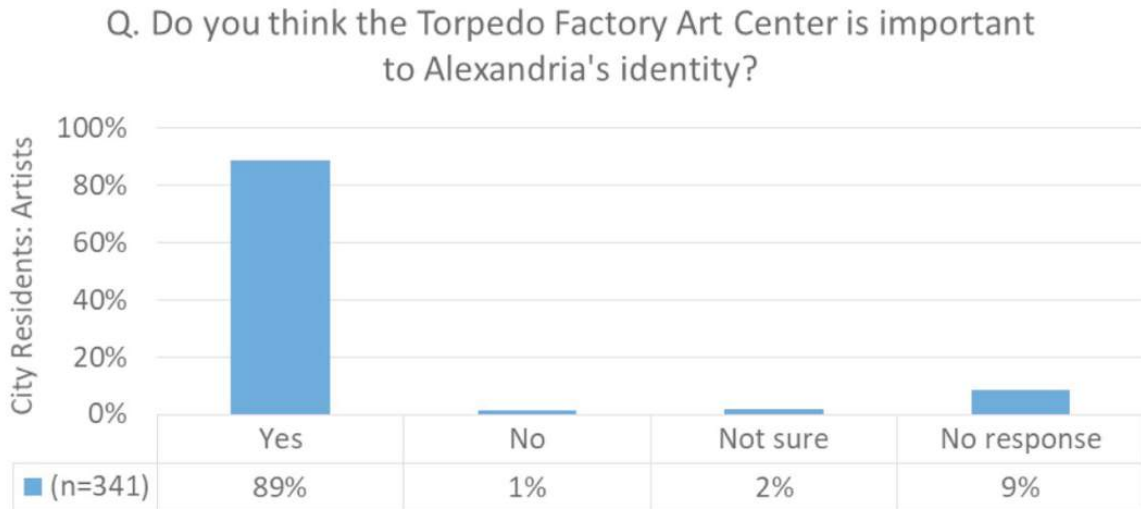
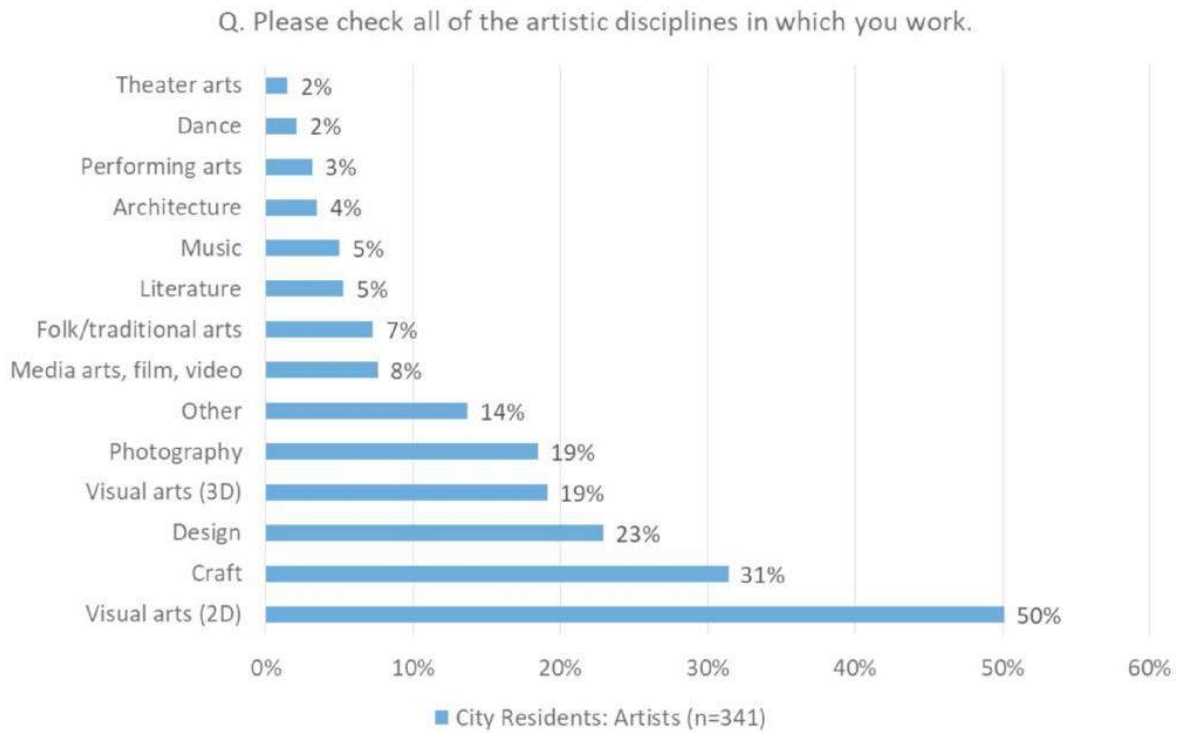

Chart 56. Respondent Artistic Disciplines Practiced



Other artistic disciplines mentioned specifically included: drawing, painting, art in schools, ceramics, workshops, jewelry, textiles, art therapies, dance, knitting, mosaics, music, photography, printmaking, sculpture, beading, calligraphy, writing, engraving, floral design, mixed media, papier-mâché, ritual arts, and theatre.

Chart 57. Teaching Artists

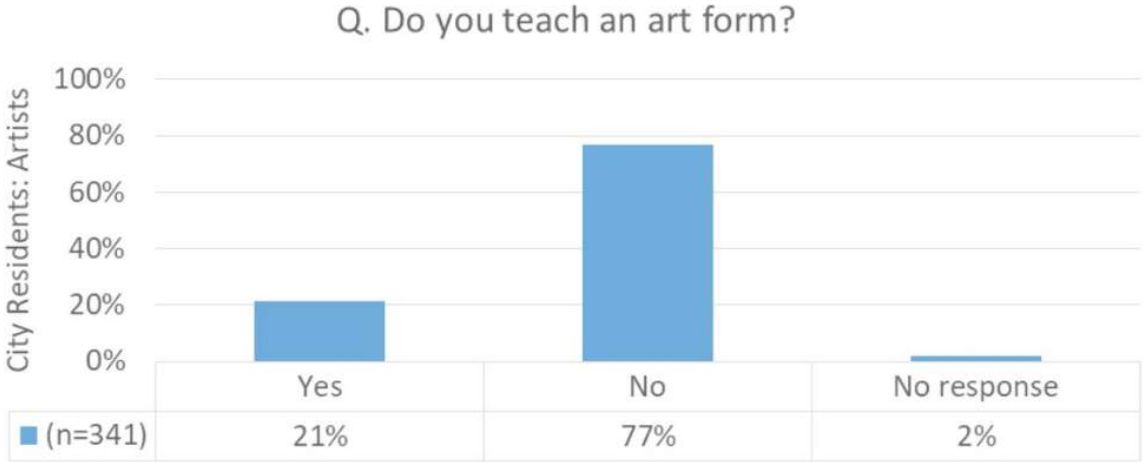

Chart 58. Issues of Importance to Alexandria Artists

Q. Please rank the following by importance to you as an artist.	Rank
Opportunities to learn a living as an artist	1
Affordable workspace in which to create my art	2
Resources to develop my artistic practice	3
Affordable retail space to see my art or service	4
Resources to develop my art business	5
Opportunities to connect with other artists or arts organizations	6

The Torpedo Factory Artists' Association is a membership-based artist community operating out of the Torpedo Factory Art Center. Because TFAA provides a variety of services to professional artists, some of whom lease studios from the City in the Torpedo Factory Art Center, the ranking of issues on the survey was segmented by artists designating affiliation with TFAA and by artists unaffiliated with TFAA to look for variances in needs of Alexandria artists.

Of the 341 artist surveys used for this study, 23% (64) were from artists that self-defined as being affiliated with TFAA.

Chart 59. Issues of Importance to Alexandria Artists by Affiliation with the Torpedo Factory Artists' Association (TFAA)

Q. Please rank the following by importance to you as an artist.	Rank (n=64, TFAA Affiliated)	Rank (n=277, Not TFAA Affiliated)
Affordable workspace in which to create my art	1	3
Opportunities to earn a living as an artist	2	1
Affordable retail space to sell my art or service	3	6
Resources to develop my art business	4	5
Resources to develop my artistic practice	5	2
Opportunities to connect with other artists or arts organizations	6	4

Chart 60. Respondent Relationship with the Alexandria Office of the Arts

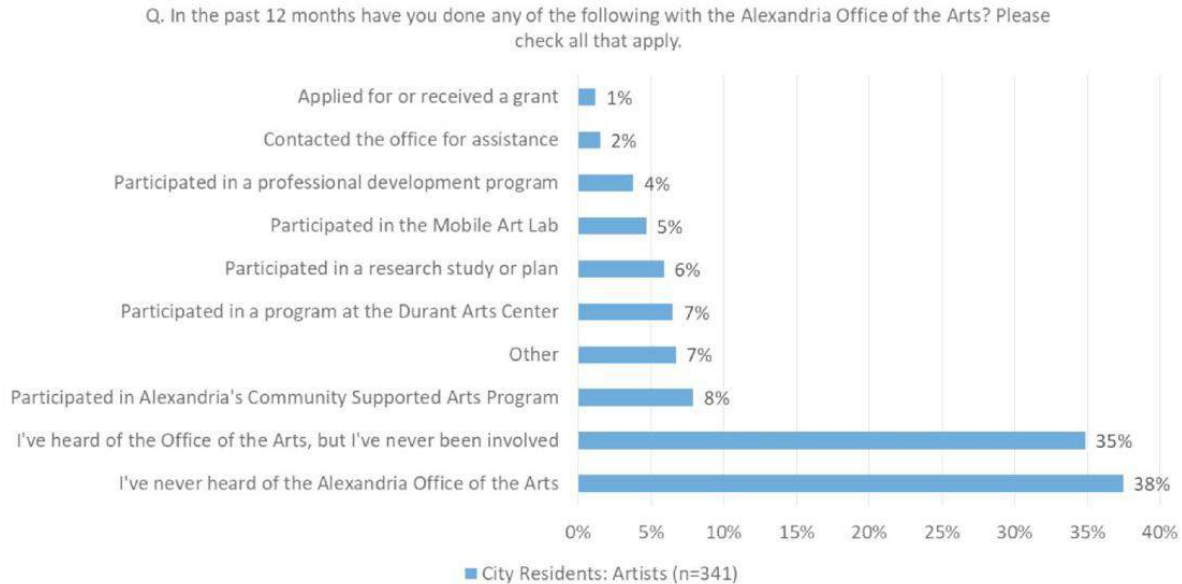

Other ways in which responding artists said they have been involved with the Office of the Arts includes: volunteering, teaching, festivals, public art program, on City Arts Commission, or City facility leaseholder.

Chart 61. Where Respondents Turn for Support

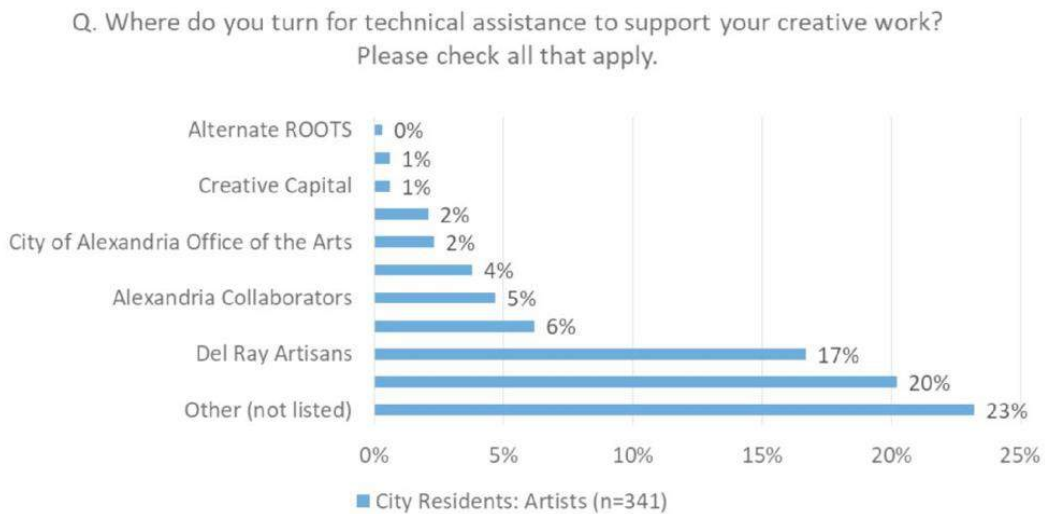

Other places where artists said they turn for support include: other artists, online resources, professional organizations, schools, Workhouse Arts Center, publications, Convergence, Discover Graphics, Smithsonian, social media, and TechShop.

Chart 62. Respondent Interest in Professional Development Services

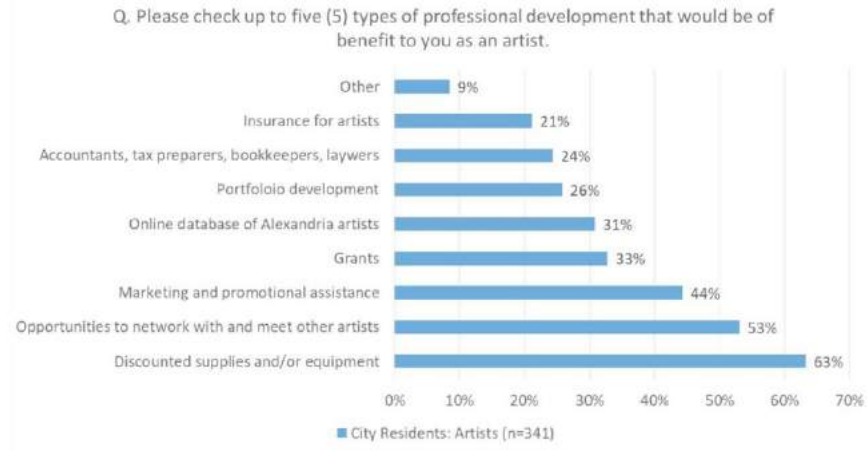

Other services artists said would benefit them include: marketing and advertising, opportunities to network with other artists, classes/workshops on a variety of topics, affordable studio/gallery/retail space, opportunities to network with art buyers, opportunities to collaborate with the City, informal gathering spaces, internships with professional artists.

Chart 63. Respondent Interest in Professional Development Services by Affiliation with TFAA

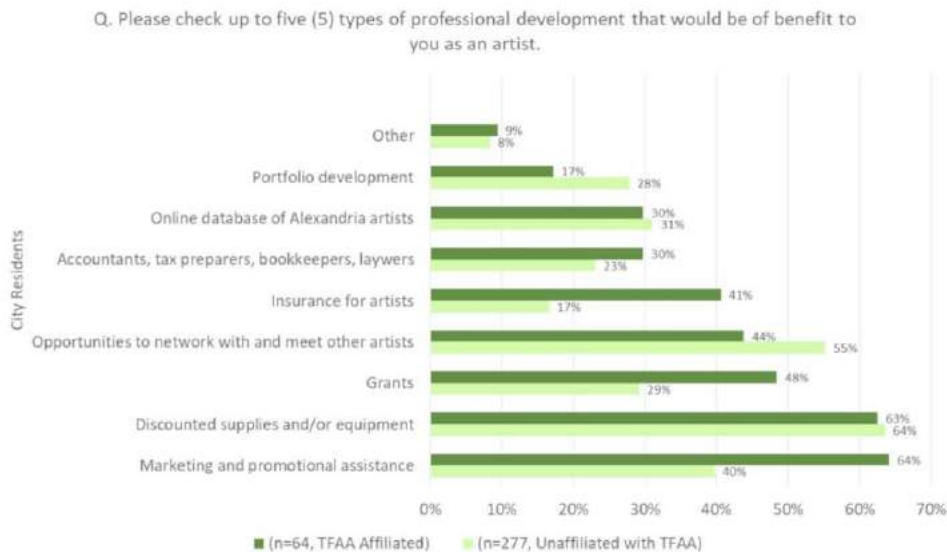

As with the question of issues of importance to Alexandria artists, interest in professional development services and space needs were segmented by artists designating affiliation with TFAA and by artists unaffiliated with TFAA to look for variances in needs of Alexandria artists that could be met through future services.

Chart 64. Respondent Current Space Needs

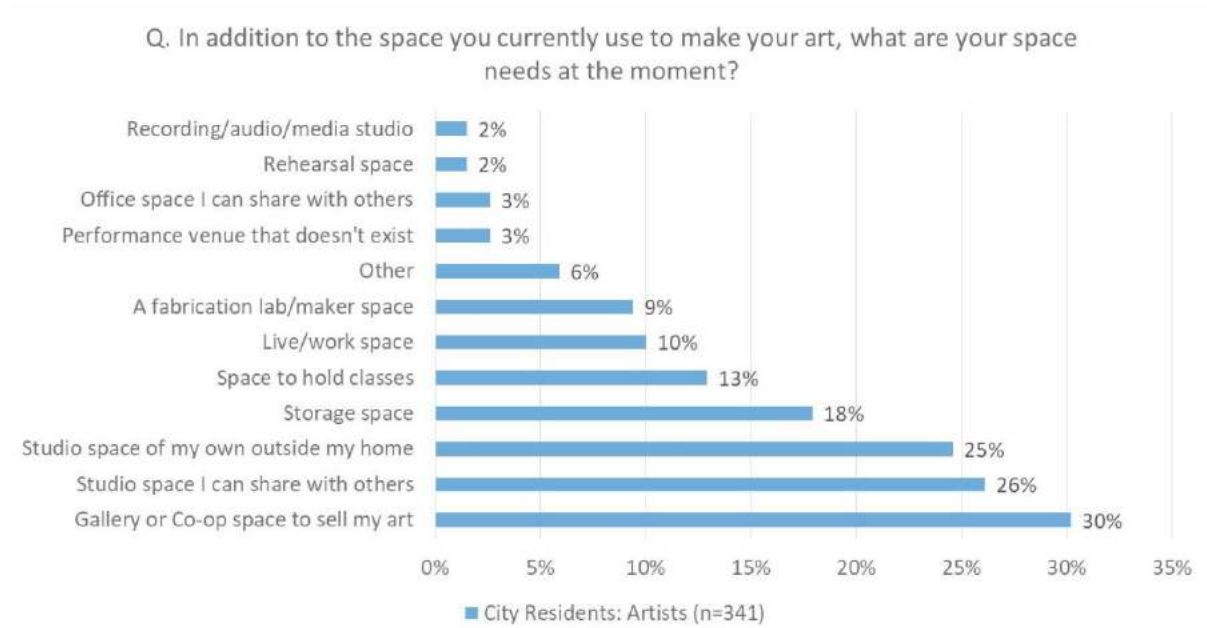

Chart 65. Respondent Current Space Needs by Affiliation with TFAA

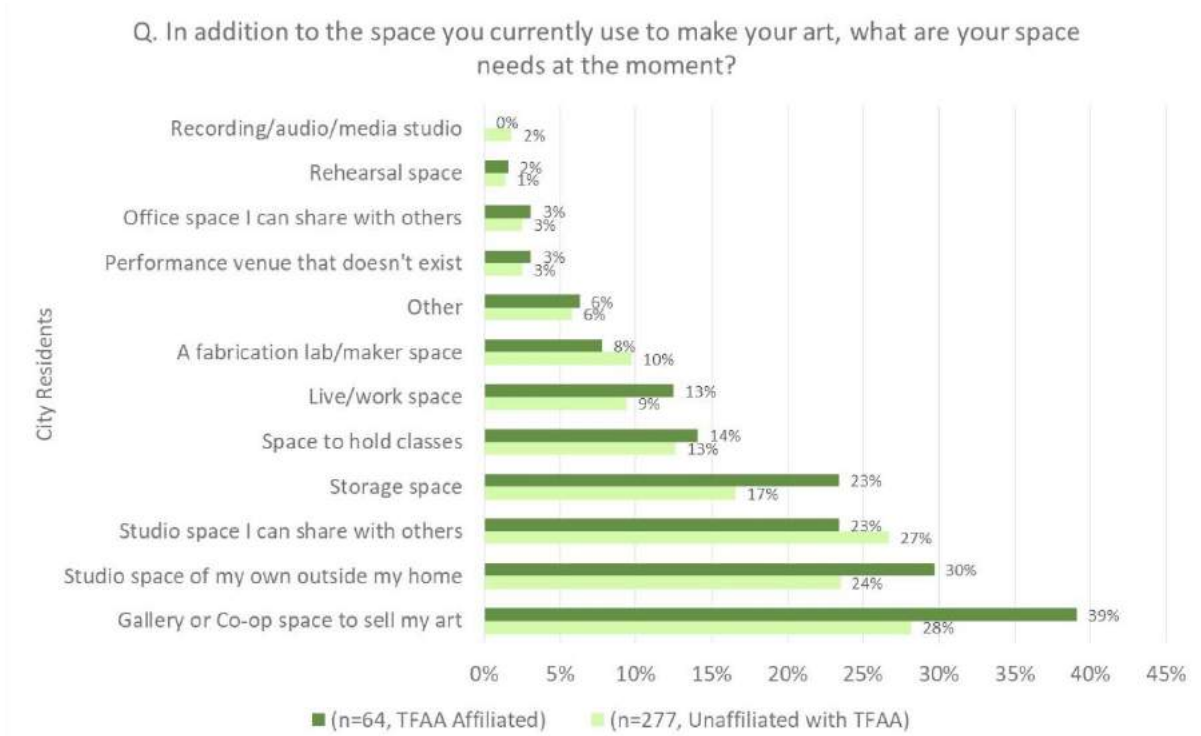

Chart 66. Respondent Space Needs by Discipline

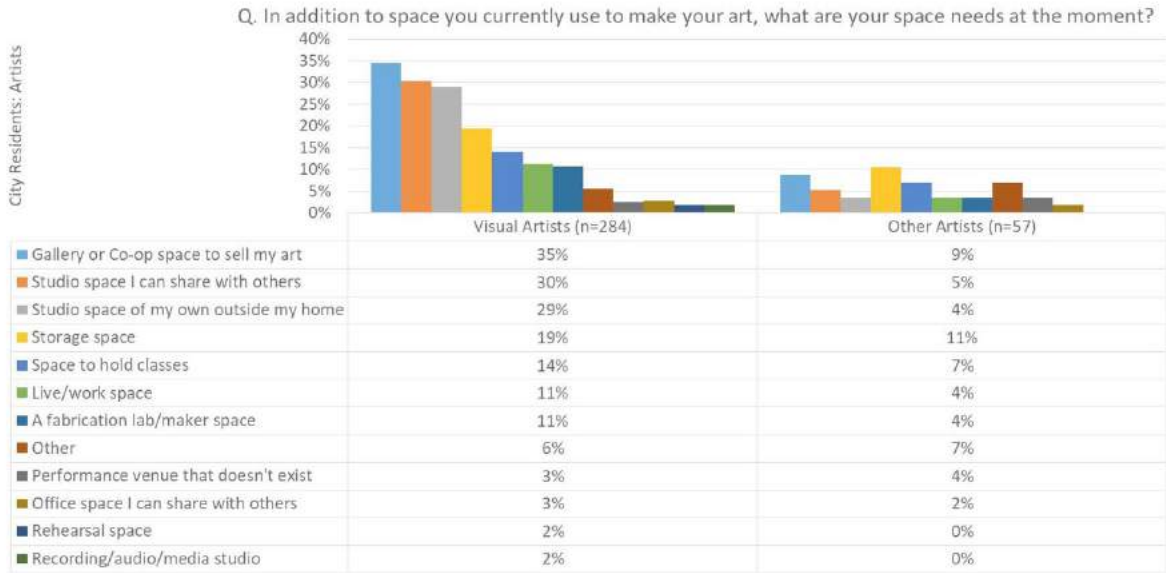
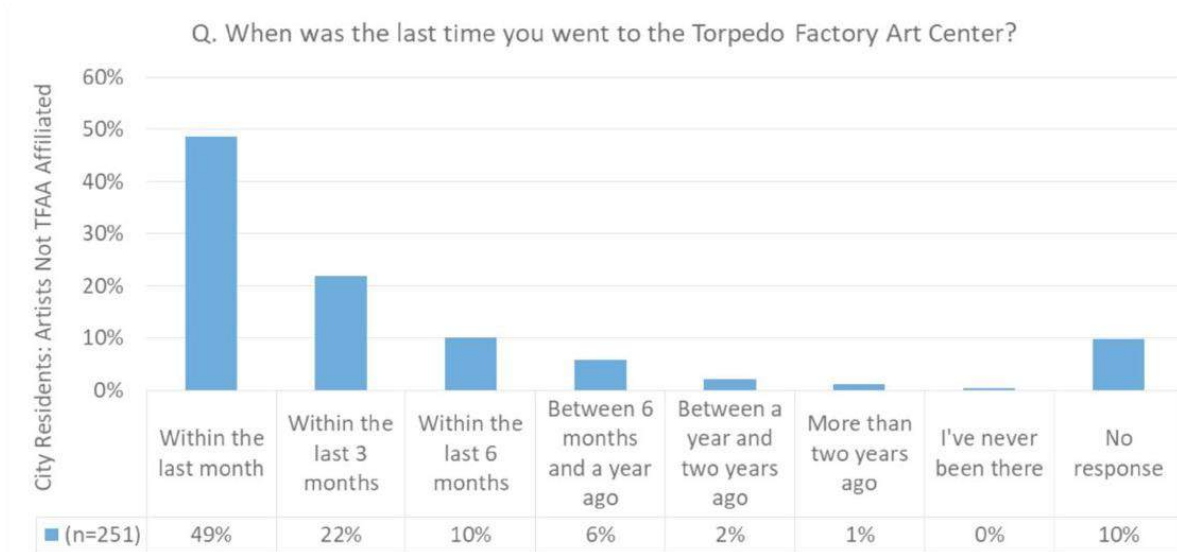

Chart 67. Respondent Last Visit to Torpedo Factory Art Center (Artists Not Affiliated with TFAA)



Because several prior studies exist that are specific to the interests, needs, and opinions of TFAA members, questions about daily use, experiences, and preferences with regard to the Torpedo Factory Art Center were posed on the Community Engagement Research survey of artists only to Alexandria artists not affiliated with TFAA.

Chart 68. Frequency of Visits to Torpedo Factory Art Center (Artists Not Affiliated with TFAA)

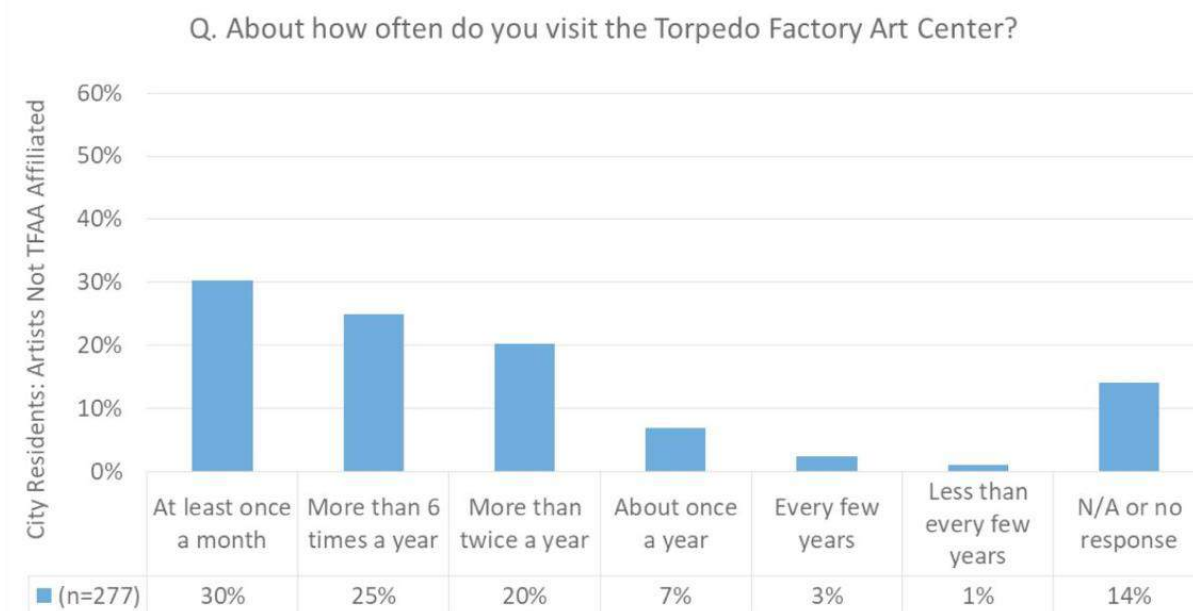

Chart 69. Frequency of Visits to Torpedo Factory Art Center by Discipline (Artists Not Affiliated with TFAA)

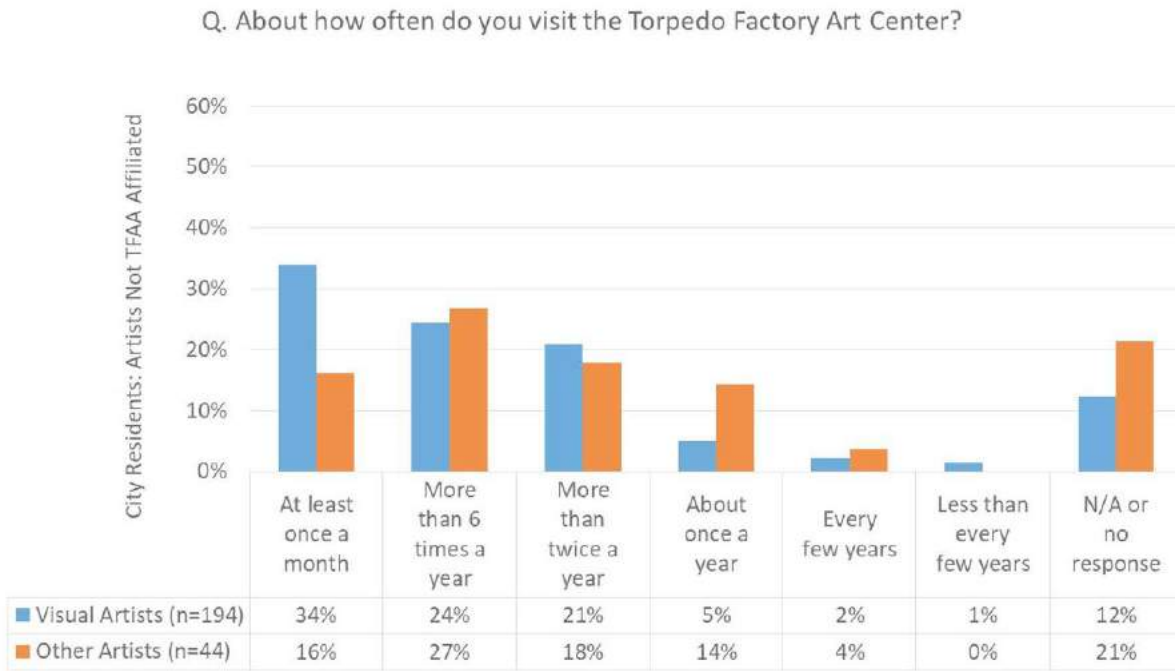

Chart 70. Frequency of Visits to Torpedo Factory Art Center by Age Group (Artists Not Affiliated with TFAA)

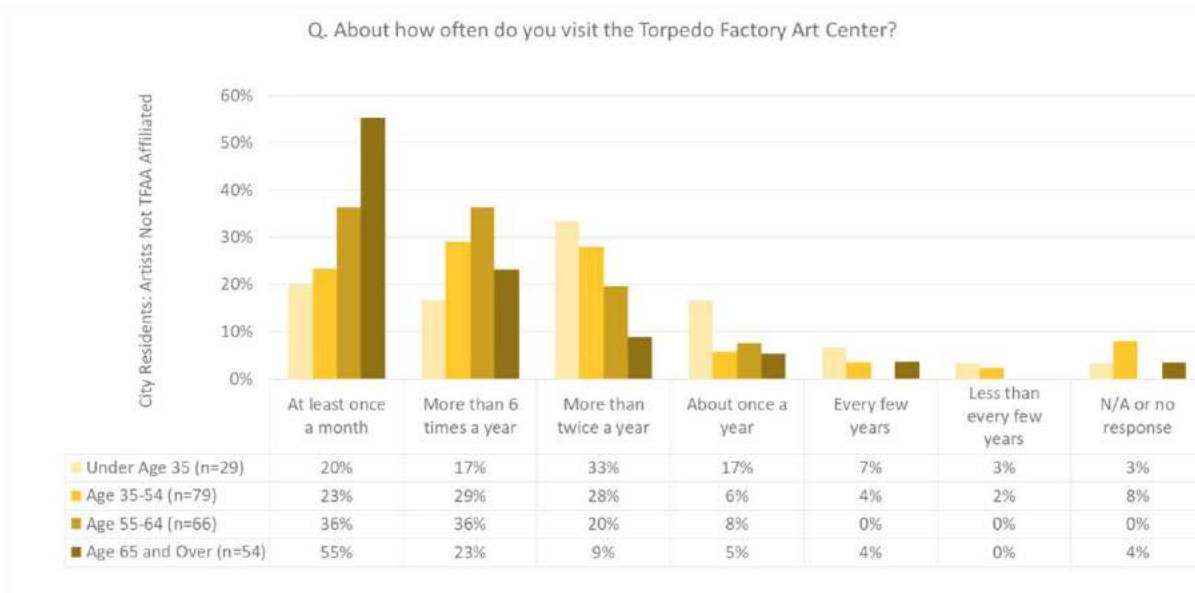

Chart 71. Respondent Reasons for Visiting Torpedo Factory Art Center (Artists Not Affiliated with TFAA)

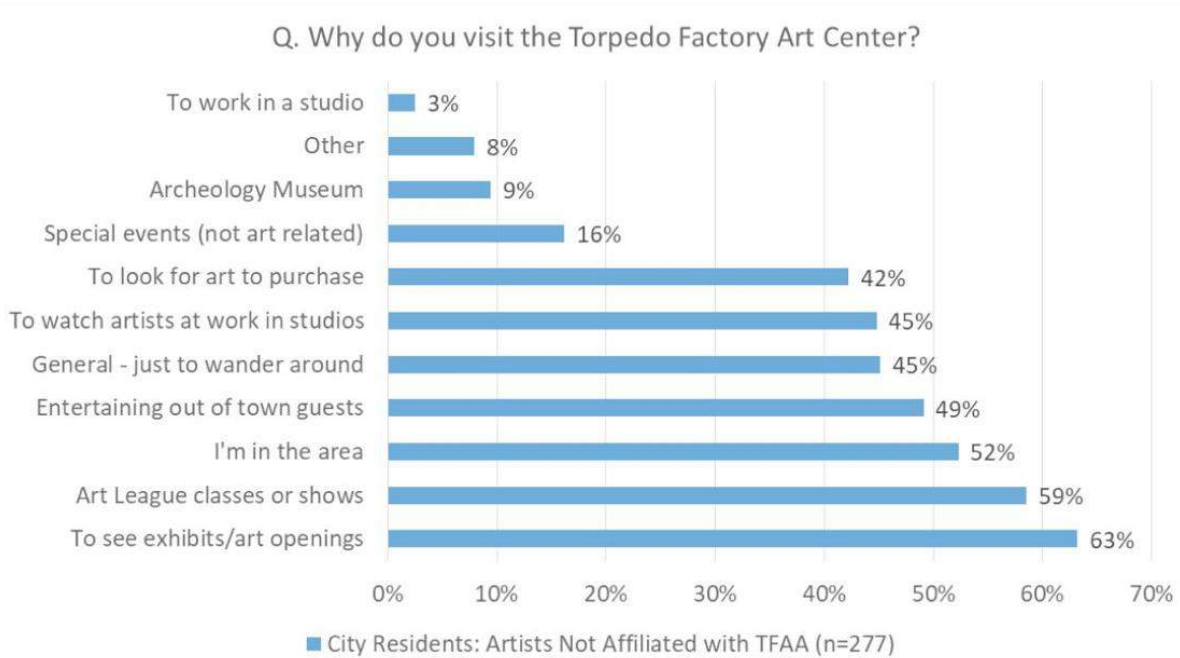

Chart 72. Respondents Reasons for Visiting Torpedo Factory Art Center (Artists Not Affiliated with TFAA) by Age Group

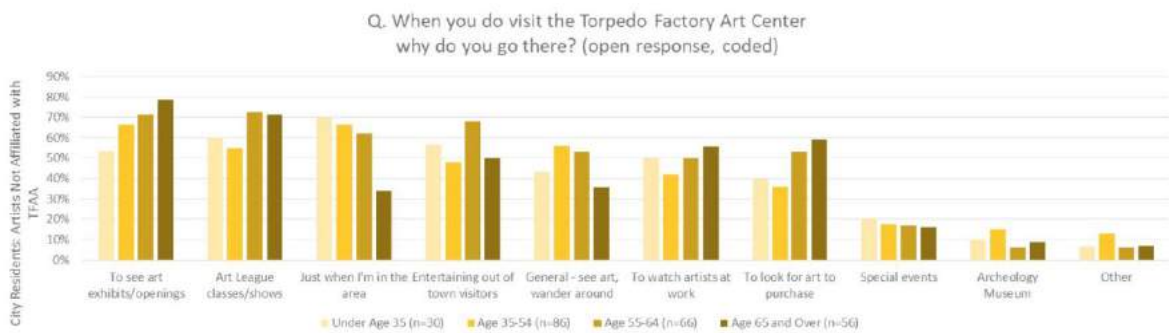

Chart 73. Respondents Reasons for Visiting Torpedo Factory Art Center (Artists Not Affiliated with TFAA) by Discipline

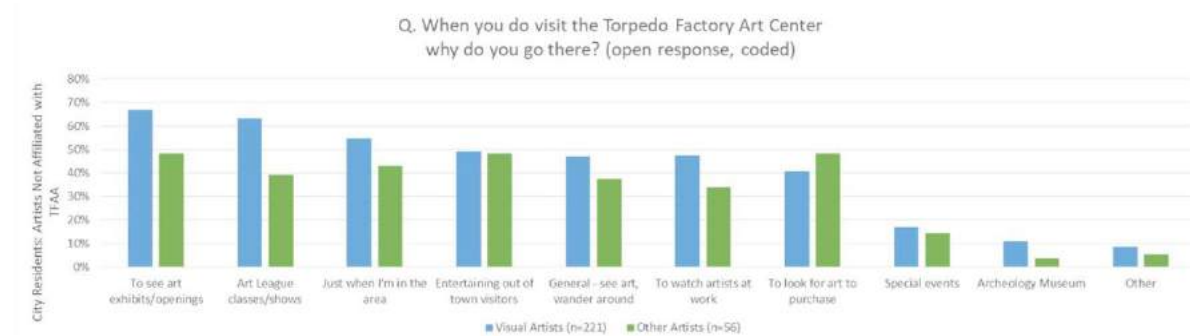

Chart 74. Convenient Times for Artists to Visit Torpedo Factory Art Center (Artists Not Affiliated with TFAA)

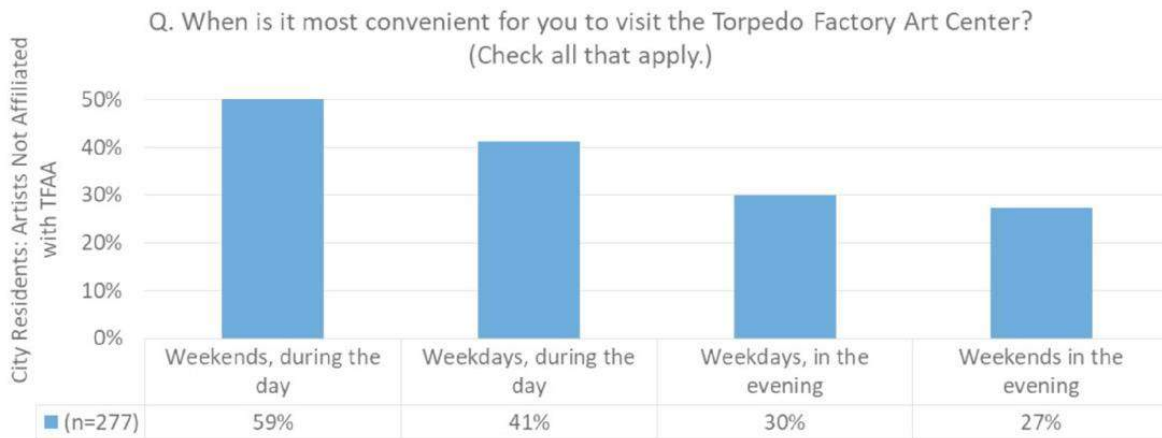

Chart 75. Respondent Satisfaction with Last Visit to Torpedo Factory Art Center (Artists Not Affiliated with TFAA)

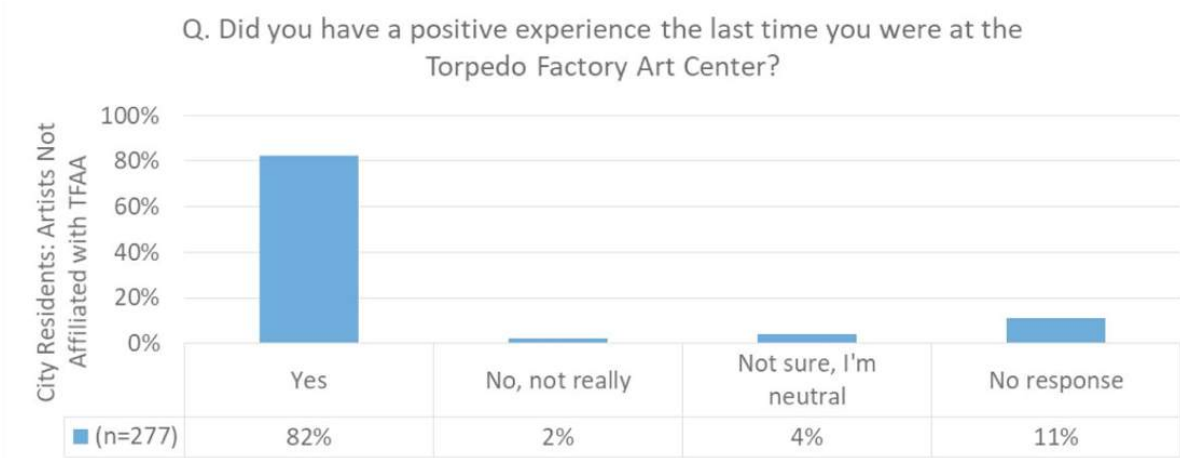
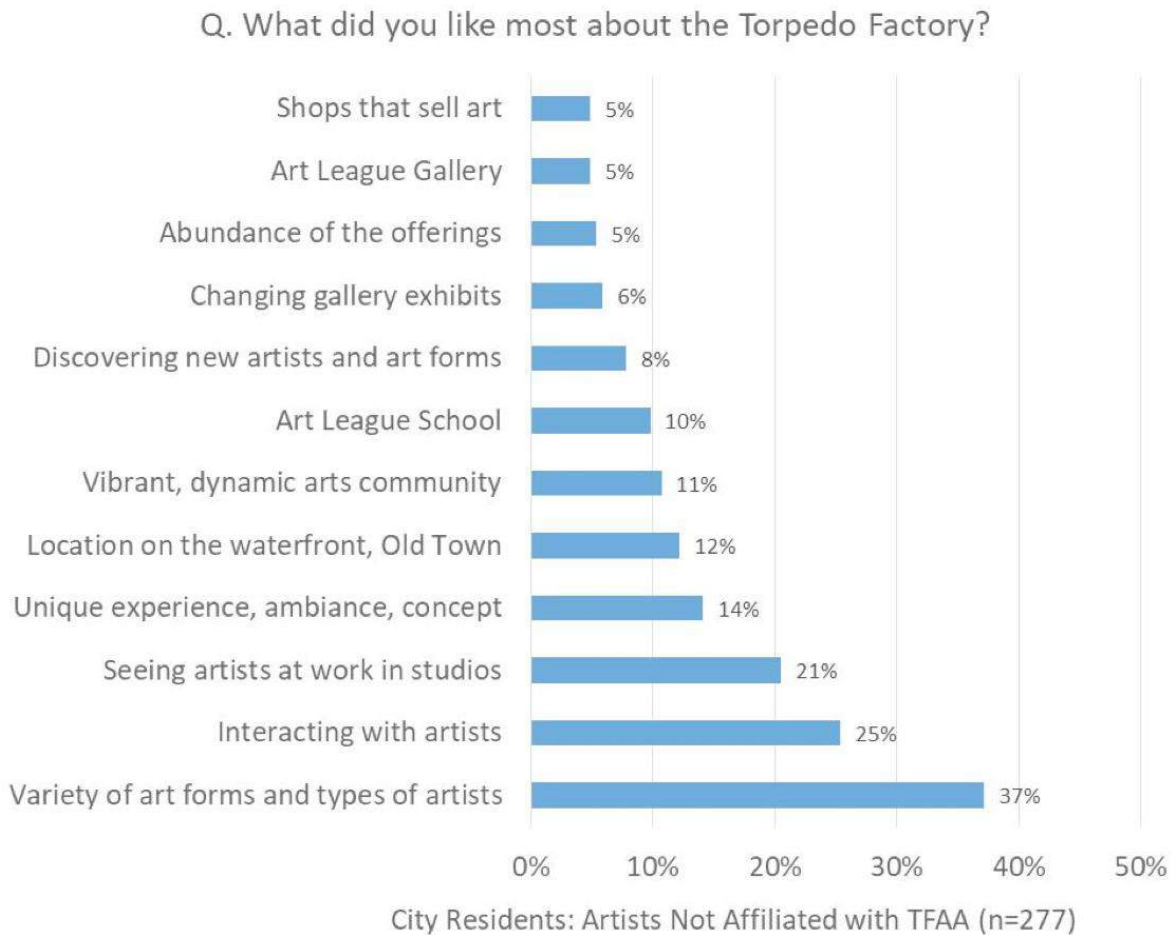
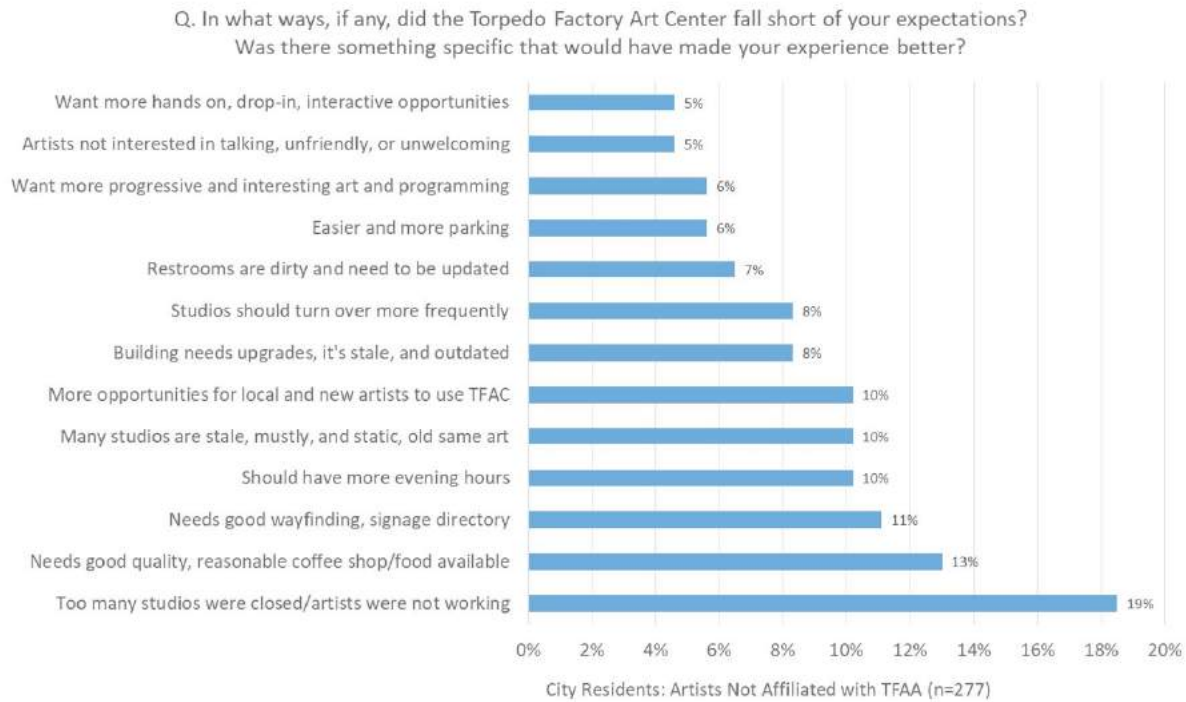

Chart 76. What Respondents Like Most About Torpedo Factory Art Center (Artists Not Affiliated with TFAA)



Results are shown for percentages over 5%. Five percent or fewer respondents mentioned the other following reasons: history, openness, Art League store, quality of art work, supporting artists, events/talks/concerts, inspiration, variety of price points, Target Gallery, expertise of teaching artists, café, that it is free, gift shop, easy parking, student gallery, friendly staff, late hours.

Chart 77. What Respondents Felt Did Not Meet Expectations at Torpedo Factory Art Center (Artists Not Affiliated with TFAA)



Results are shown for percentages over 5%. Five percent or fewer respondents mentioned the other following reasons: uneven quality of art, better store, no bookstore/writers, generic vendors, lack of signage, want more diverse artists (age and race), want more affordable art, more diverse art forms, want better use of waterfront views and outdoor areas, want classical/traditional art, more places to sit/relax, better promotion, better exhibits, want Art League timeline, bad/closed gift shop, didn't feel welcome, want more community outreach, trending too commercial, want more for children, want better use of the public space.

Chart 78. Respondent Feelings about City Support of Artists through Discounted Rates at Torpedo Factory Art Center

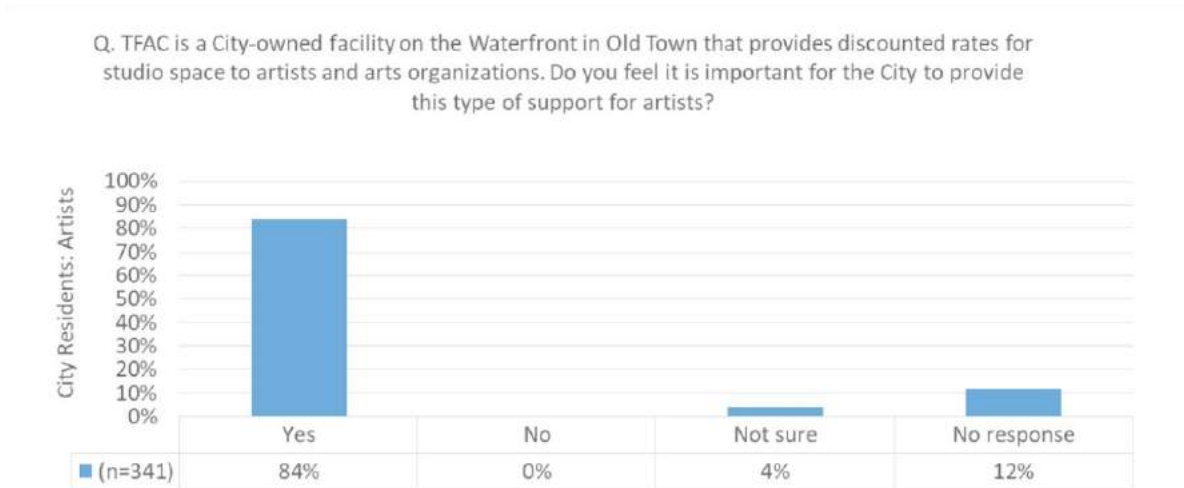

Chart 79. Respondent Feelings about Access to Discounted Space Rates at Torpedo Factory Art Center and Status of Artist Residency

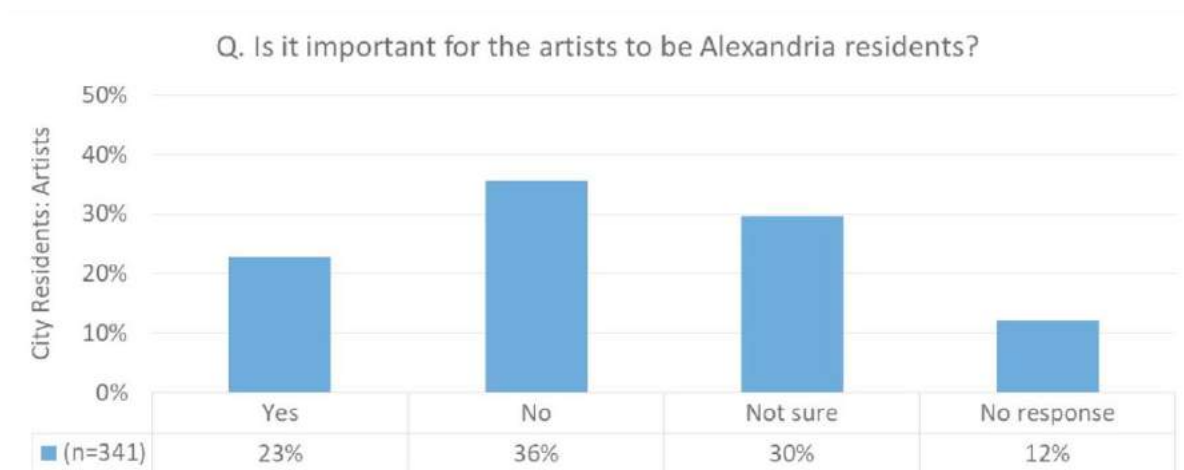

Chart 80. Respondent Feelings about Access to Discounted Space Rates at Torpedo Factory Art Center and Status of Artist Residency by Affiliation with TFAA

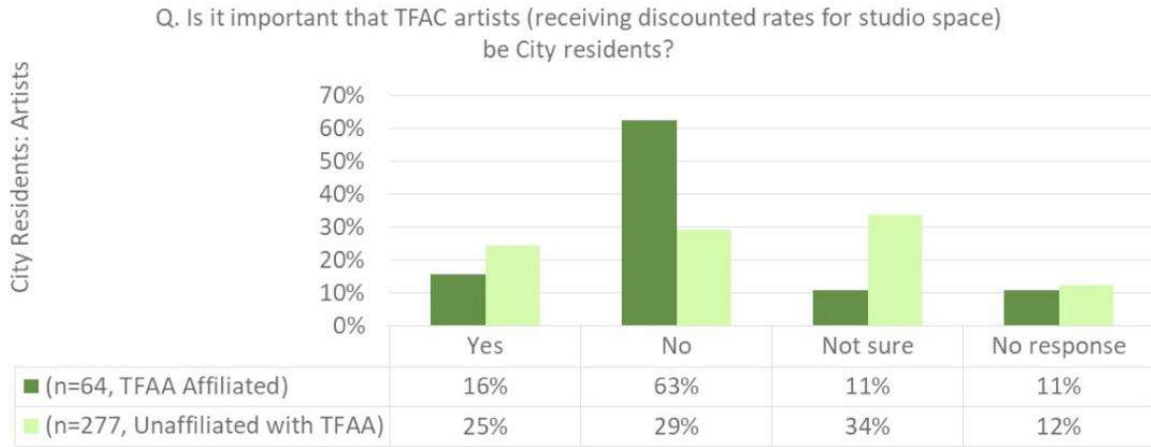
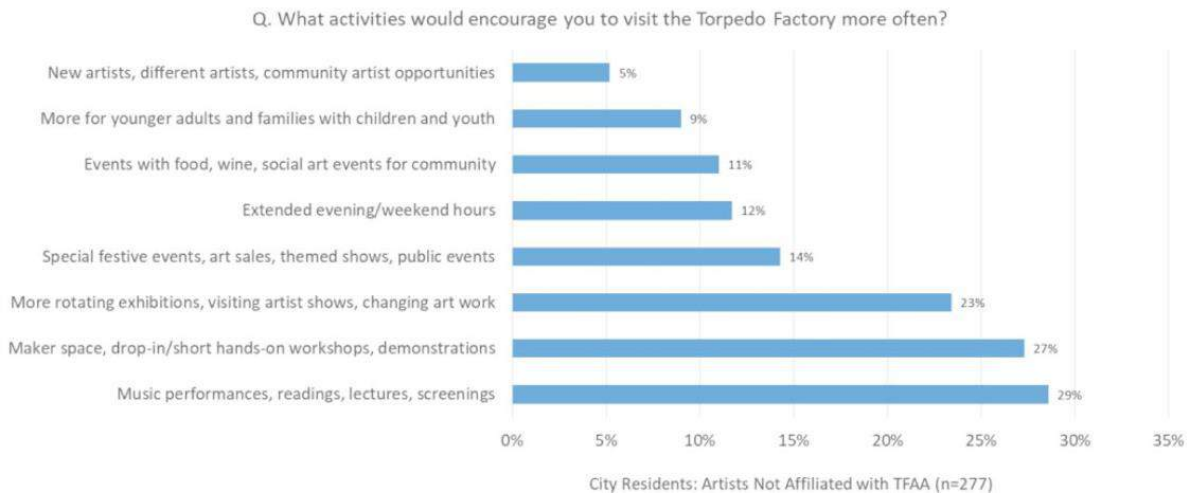

Chart 81. What Would Encourage Respondents to Visit Torpedo Factory Art Center More Often (Artists Not Affiliated with TFAA)



Results are shown for percentages over 5%. Five percent or fewer respondents mentioned the other following reasons: cheaper parking, higher quality art/curation, better event marketing, studios that are open with working artists, better café/rooftop restaurant, use of outdoor space, street-level windows, art walks, dancing.

RESPONDENT CHARACTERISTICS

Chart 82. Respondent Age

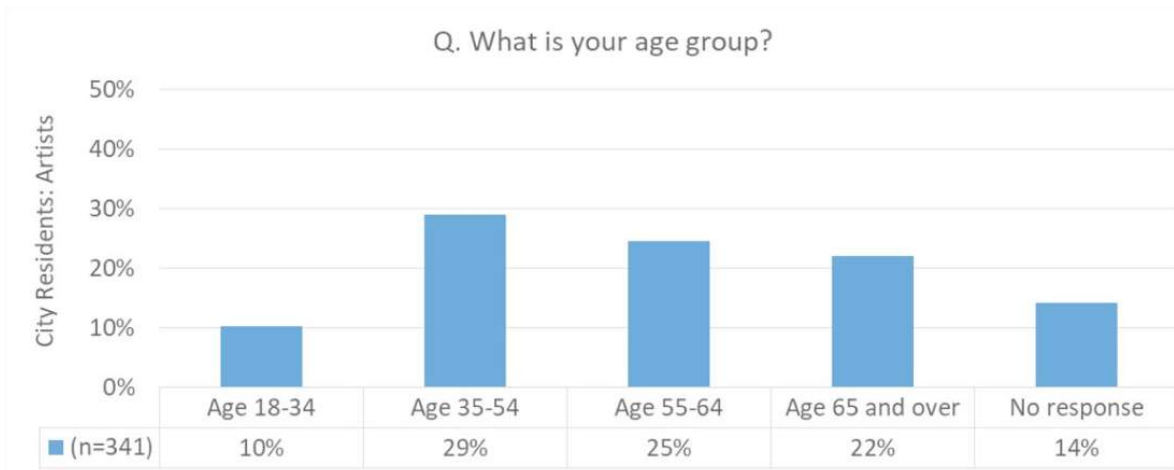

Chart 83. Respondent Age by Affiliation with TFAA

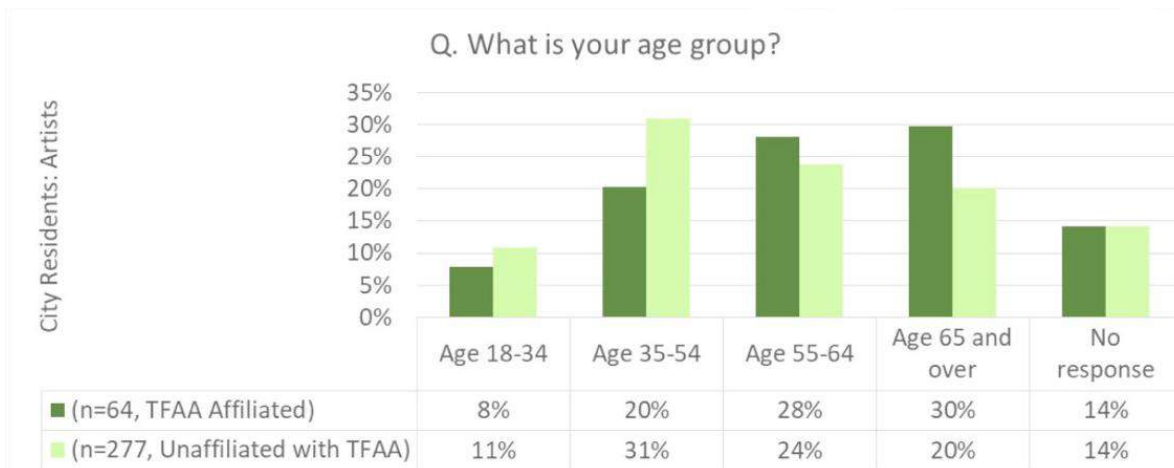

Chart 84. Respondent Race

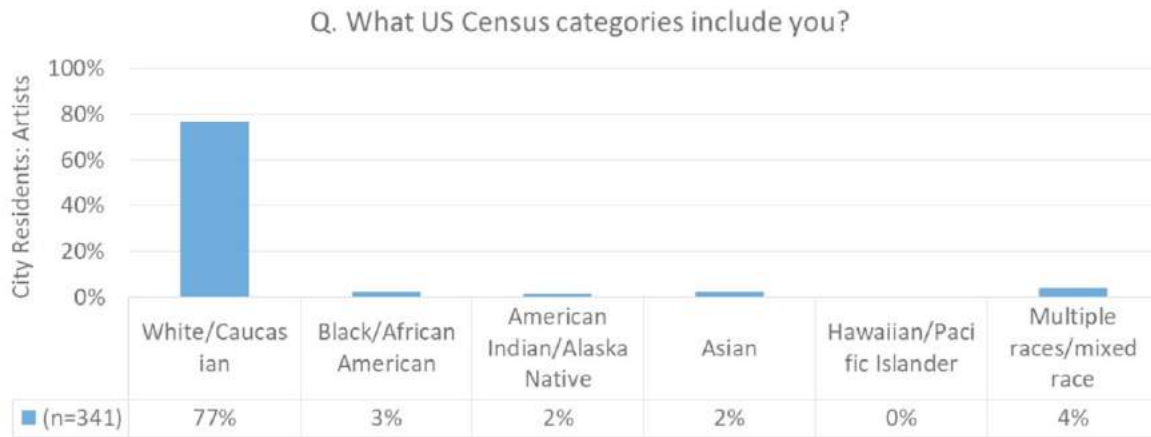

Chart 85. Respondent Race by Affiliation with TFAA

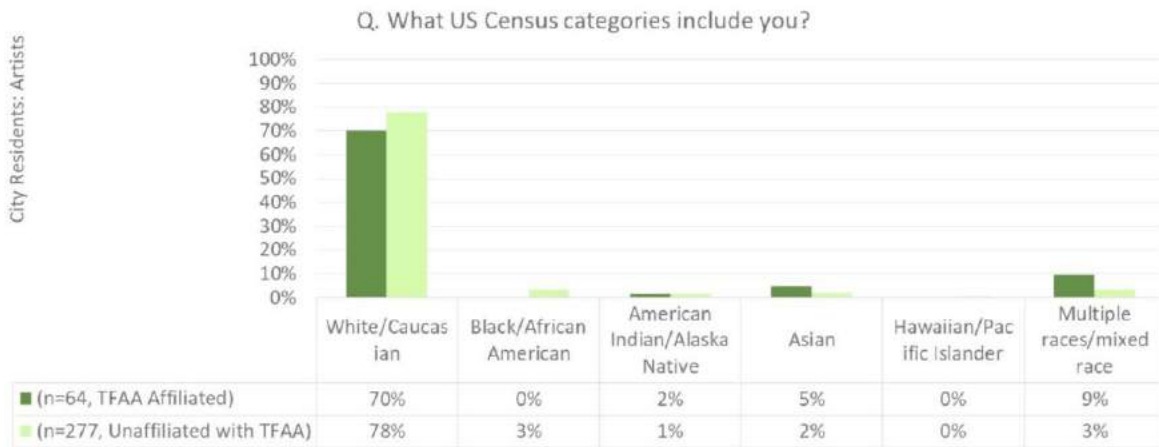

Chart 86. Respondent Percentage Hispanic Origin

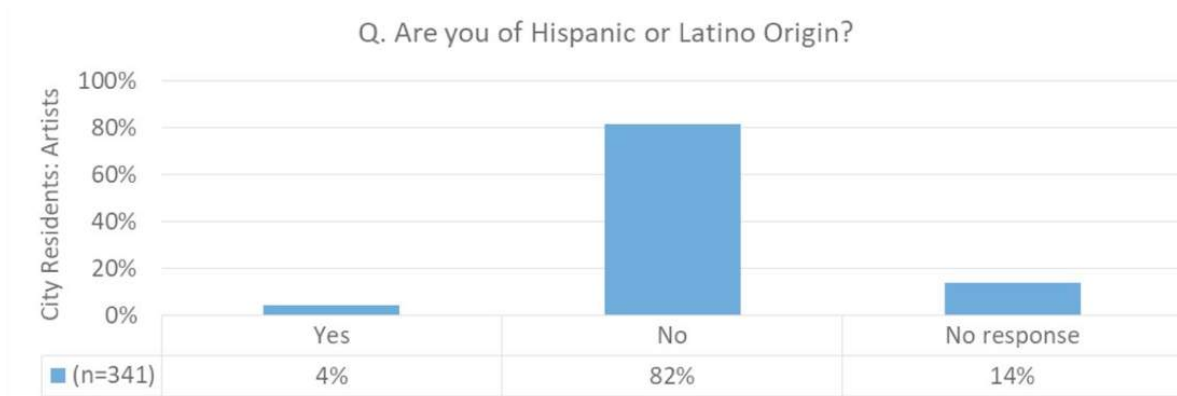

Chart 87. Respondent Percentage Hispanic Origin by Affiliation with TFAA

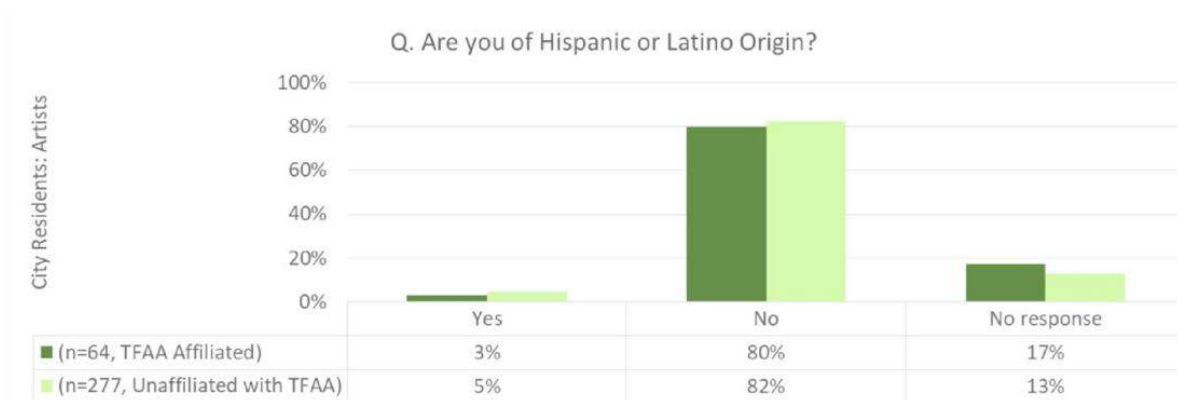
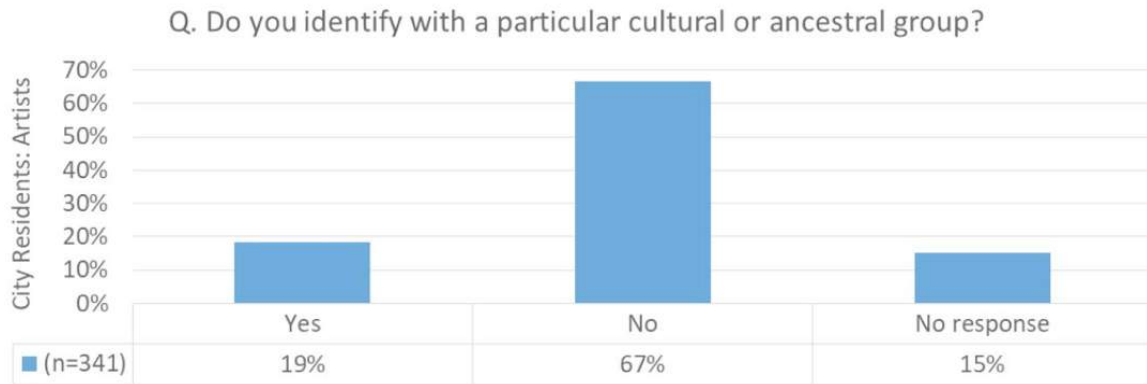
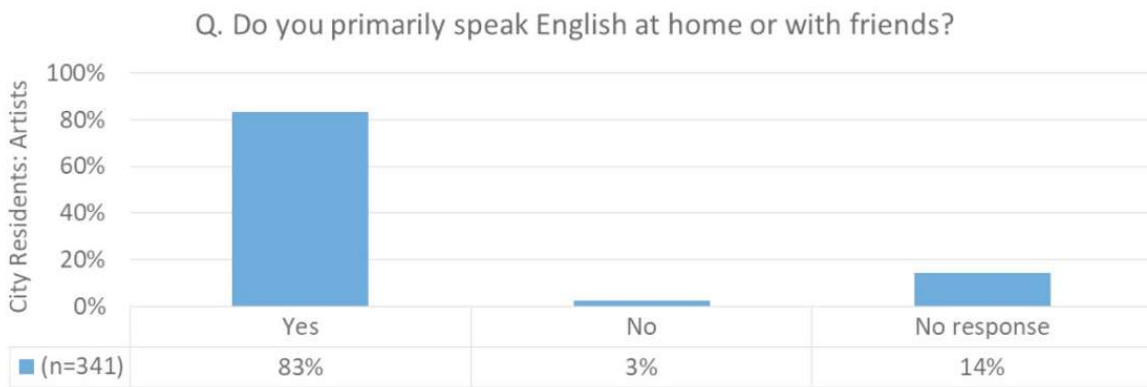

Chart 88. Respondent Affiliation with Specific Cultural or Ancestral Groups



Groups mentioned included: Anglo-Saxon, Armenian, African American, British, Chicano, Dutch, American Indian, Eastern European, Swiss, German, Irish, Italian, Jewish, Mexican, Scottish, Scandinavian, French, French Canadian, and New Mexican.

Chart 89. Respondent Languages Spoken at Home or with Friends



CITY GOAL

CITY GOAL:
**BROADEN AND DEEPEN THE ART CENTER’S COMMUNITY
CONNECTIVITY**

Over 10 months, comments and data about the Torpedo Factory Art Center were collected from Alexandrians providing information and insights about its current value to them and how to increase it. As in the City of Alexandria’s Strategic Plan, themes are described separately yet intertwine with and impact one another. This report’s findings and recommendations are divided into four sections: Purpose, Programs, Place, and Promotion. These sections bring forward the key results gleaned from the quantitative surveys.

Purpose	Programs	Place	Promotion
Fortify “the why” to more genuinely connect with Alexandrians	Diversify and invigorate offerings to keep pace with Alexandrians’ interests	Improve and optimize space utilization	Amplify “the why” to increase Alexandrians’ awareness and knowledge of all offerings

Section 1: Purpose

This section includes data and information about Alexandrians' familiarity with the Art Center, its purpose, and the extent to which Alexandrians visit, participate, and why they visit. Recommendations are offered to the City that will fortify the Art Center's connection with and value to all Alexandrians: honor the vision of the founders, refresh how artists and art connect with Alexandrians, and expand creative supply in response to community demand.

Section 2: Programs

This section provides insight as to the creative interests of Alexandrians: specifically, information about interests of those who frequent the Art Center and the waterfront. Recommendations are offered for the City's consideration that would diversify and expand creative opportunities both inside and outside the facility through programming that keeps better pace with Alexandrians' interests.

Section 3: Place

This section is about revitalizing the Art Center as a more dynamic place for the enjoyment of all Alexandrians and visitors. Findings and recommendations from interviews, focus groups, and survey comments also relate to building appearance, a sense of welcome, accessibility, and ease in navigation. Also included are recommendations for the City's consideration to optimize the Art Center's spectacular waterfront location as a creative gathering place, linked to other activities in order to achieve wider-ranging community benefit.

Section 4: Promotion

This section focuses on Alexandrians' awareness of the Art Center and how to improve it. Once the City's plan for the Art Center as *a more sustainable place for the arts and artists in Alexandria* is set, recommendations include communicating those plans through marketing and promoting a new, more cohesive and clear brand. If the waterfront is, in fact, "a place Alexandria residents inhabit - not only visitors - and belongs first to Alexandrians,"¹ communicate to Alexandrians how Torpedo Factory Art Center will be a primary catalyst in the City's April 2018 announced plan to revitalize the waterfront.

At the end of each section is a one-page summary of key recommendations based on the overall analysis of research findings in that section. **As this document is not a plan, the summary is intended to help guide the City in its decision making with regard to its efforts to broaden and deepen the Art Center's community connectivity.**

¹From Alexandria Waterfront History Plan, 2010. The City of Alexandria Archaeological Commission.

SECTION 1. PURPOSE

FORTIFY "THE WHY" TO MORE GENUINELY CONNECT WITH ALEXANDRIANS

This section includes data and information about Alexandrians’ familiarity with the Art Center, its purpose, and the extent to which Alexandrians visit, participate, and why they visit. Recommendations are offered to the City that will fortify the Art Center’s connection with and value to all Alexandrians: honor the vision of the founders, refresh how artists and art connect with Alexandrians, and expand creative supply in response to community demand.

Findings: What city residents know about Torpedo Factory Art Center

- ▶ Ninety-three percent (93%) of city residents are familiar with the Art Center.

Table 7. Level of Familiarity with Torpedo Factory Art Center

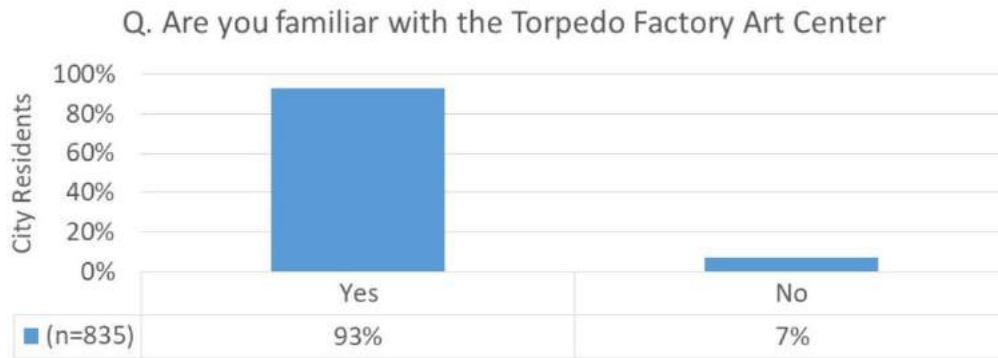

- ▶ 88% of city residents think Torpedo Factory Art Center is important to Alexandria’s identity.

Table 8. Level of Importance of Torpedo Factory Art Center to Alexandria

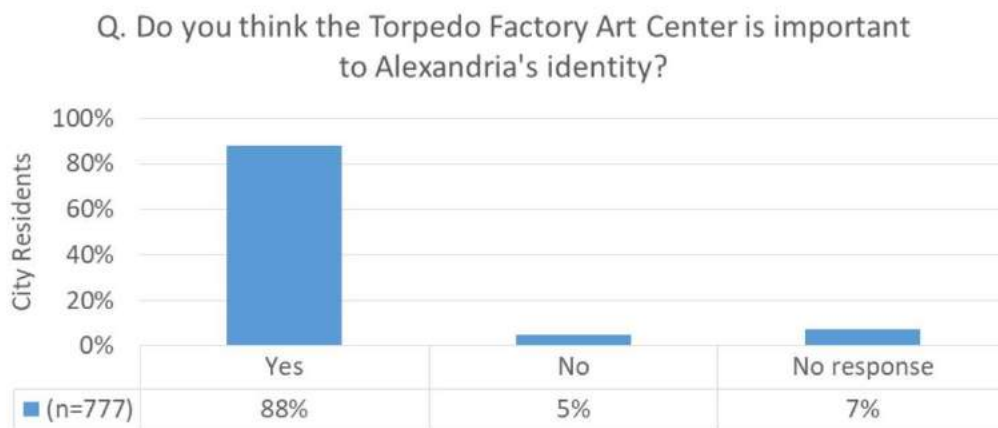

- ▶ Though Alexandrians’ familiarity with the Art Center is high, resident participation is low. In Table 9 below, Torpedo Factory Art Center visitor frequency was categorized into two groups: those visiting the Art Center six times per year or more and those visiting once a year or less. Seventy percent (70%) of city residents are infrequent visitors.

Table 9. ZIP Codes of City Resident Survey Respondents by Frequent and Infrequent Visitors

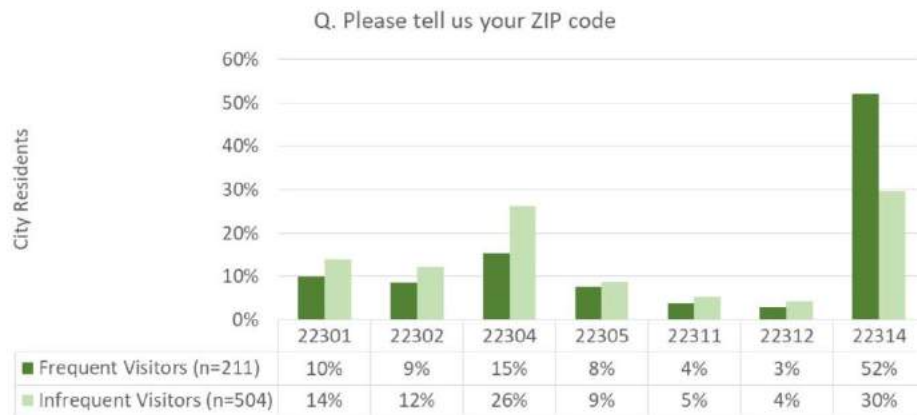
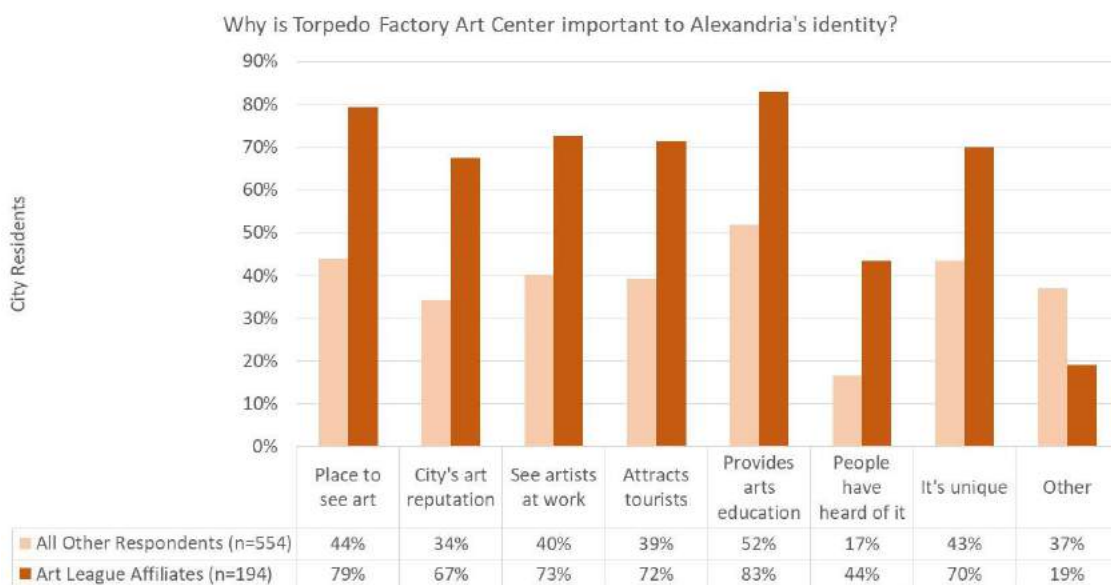

Table 10 shows data points in the City Resident Survey that reinforce the greater-appreciation/stronger-bond premise. There were substantial variances to results from the City Resident Survey to the question, “Why is the Torpedo Factory Art Center important to Alexandria’s identity?” City residents affiliated with the Art League have a much stronger sense of the relationship between the Art Center and the City’s identity than does the general public. The variance in percentages reporting reasons ranged from 27% to 35%.

Table 10. Why City Residents Believe Torpedo Factory is Important to Alexandria’s Identity



In City Resident surveys, of 88% who believe the Art Center is important to Alexandria's identity, 12% of respondents wrote in reference to its historical significance as a reason under "other". Also, among comments on the survey that mentioned history it was noted that the facility does not highlight enough of the facility's WWI and WWII history. Also with regard to history—the transition from munitions plant to Art Center and being on the forefront as a first in creative adaptive re-use is a story that is not well known among the general population.

The Art Center's distinctiveness as one of the first public collection of artists' studios in the nation was its early allure. Firsthand experiences with artists made visiting the Art Center unique; specifically, watching artists at work in their studios, communicating with artists directly, and purchasing art from artists.

Table 11. In What Ways Did Torpedo Factory Art Center Fall Short of Your Expectations?

- ▶ 92% of City residents surveyed indicated a positive experience when they last visited the Art Center. When asked about the experience and what would have made the visit better, 7 of 13 highlighted reasons in Table 11 below were related to criticisms of the studio experiences, artists, or art offerings (blue/white shading in the chart).

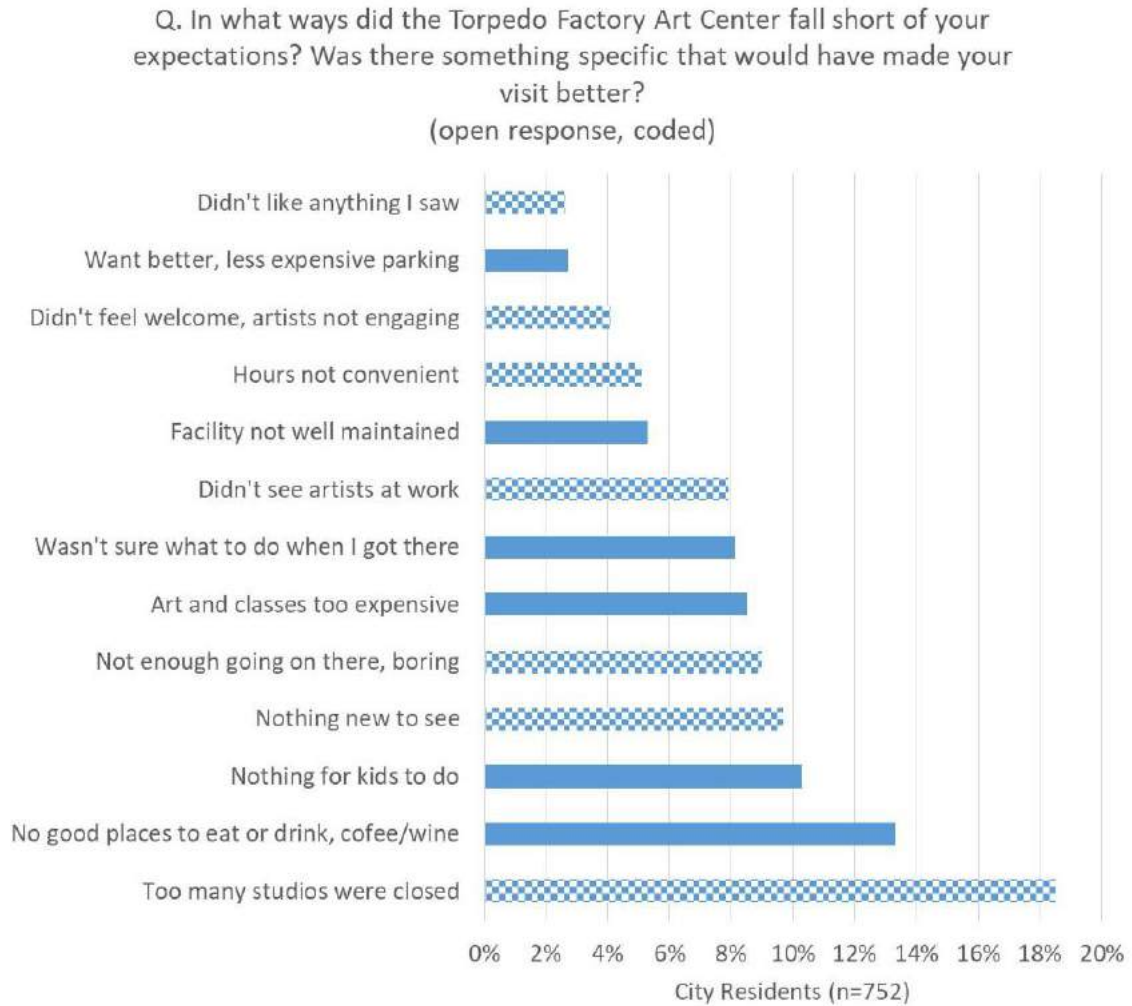
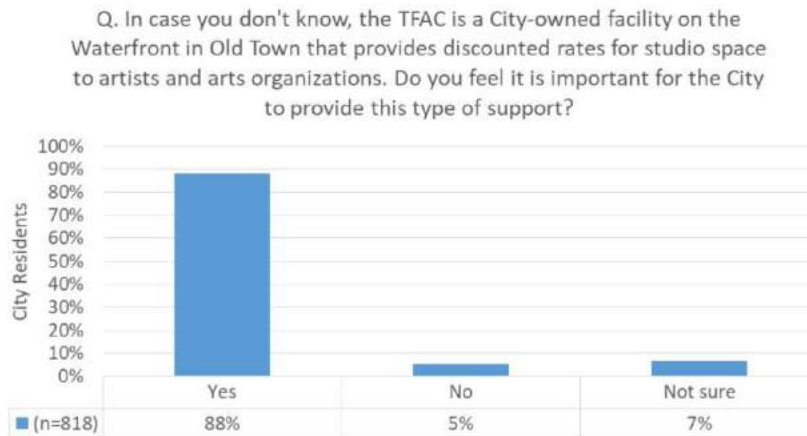

Table 12. Importance of the City to Subsidize Artists – City Residents



Alexandria artists – both with and without affiliation with the TFAA shared these opinions.

- ▶ 84% of city artists unaffiliated with TFAA believe it important for the City to provide support for artists and arts organizations. For TFAA affiliated city artists, it's 88%.²

Table 13. Importance of the City to Subsidize Artists – City Artists

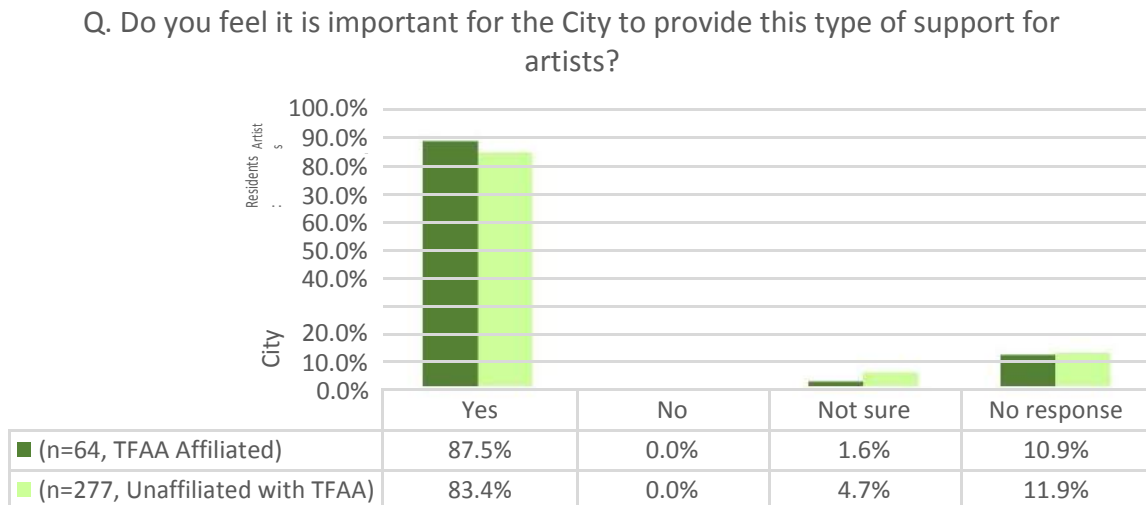

² Torpedo Factory Artists' Association (TFAA) is a membership-based professional artist community operating out of the Torpedo Factory Art Center. Because TFAA provides a variety of services to professional artists, some of whom lease studios from the City in the Torpedo Factory Art Center, the ranking of issues on the survey was segmented by artists affiliated with TFAA (self-designated) and by artists unaffiliated with TFAA to look for variances in needs of Alexandria artists.

While it is clear that a vast majority of city residents – artists and non-artists believe the City should support artists through discounted rates for studio space, the issue of whether or not city residency should be a requirement for the discount is murky.

Just over half of city residents don't think artists occupying studios need to be Alexandria residents. However, as column three shows, 22% are unsure about it. The results were similar regardless of residents' affiliation with The Art League³.

Table 14. Importance of Artists to Be City Residents – City Residents

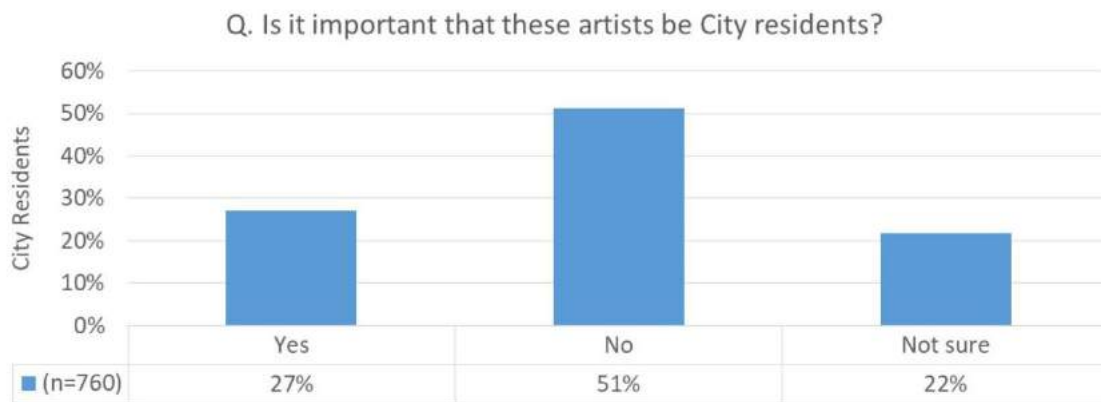
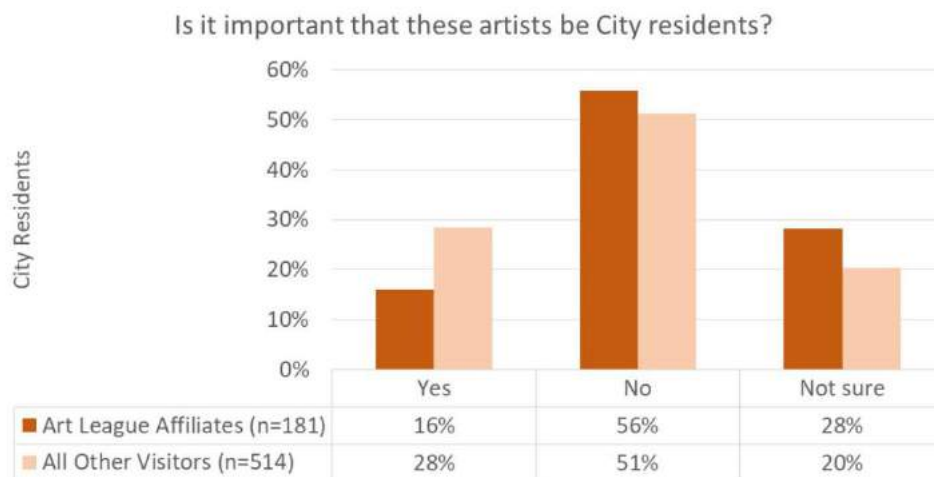

Table 15. Importance of Artists to Be City Residents – Art League Affiliation



³ Because city residents affiliated with The Art League represent a large component of daily users of the Art Center, as well as a large portion of the survey sample, segmentation was used to compare responses with other visitors to see if there were substantial variances in responses to the survey. For the purposes of segmentation, "Art League Affiliates" are defined as respondents who reported that one of the reasons they visit the Torpedo Factory Art Center is for "The Art League." This may include classes or other activities. Respondents on this question who did not report activity with The Art League were grouped into the "all other visitors" segment.

PURPOSE

RECOMMENDATIONS TO BROADEN AND DEEPEN THE ART CENTER'S COMMUNITY CONNECTIVITY

1. Affirm the City's mission for Torpedo Factory Art Center.

As the most important first step, affirm the City's mission and purpose of the Torpedo Factory Art Center and its value to Alexandrians.

2. Better curate the visitor experience.

Provide and continually improve interpretive content for Alexandrians – and all building visitors: what's in the building and why it is there along with history of the facility, using interactive media, docents, better signage, maps, and more.

3. Remind Alexandrians of the Art Center's unique creative legacy:

Continually refresh how Torpedo Factory Art Center honors and celebrates its artists and founders: Consider a commemorative wall to honor founders. Consider an emeritus gallery to exhibit founders' work.

4. Refresh and expand Alexandrians' connection with artists:

Continually refresh studio policies and artist selection process:

- Determine practices and procedures to improve the studio artists' interface with the public and see that it is consistently implemented throughout the building.
- Expand the diversity of artists to better reflect the diversity of Alexandrians (age, ethnicity, creative practice, and more.)
- Expand the diversity of visual art to reflect contemporary visual art: 2D, 3D, ceramics, fiber, metal, painting, photography, print media, and sculpture plus video art as appropriate to the space.
- Refresh the creative interface though more innovative interaction. Consider ways beyond ways of "viewing" the art, provide different ways to "experience" the art: open workspace, informal gatherings, demonstrations, and more.

5. Monitor progress:

- Assess and measure improvements to revitalize the artists' interface and connectivity with Alexandrians.

SECTION 2. DIVERSIFY PROGRAM OFFERINGS

This section provides insight as to the creative interests of Alexandrians: specifically, information about interests of those who frequent the Art Center and the waterfront. Recommendations are offered for the City’s consideration that would diversify and expand creative opportunities both inside and outside the facility through programming that keeps better pace with Alexandrians’ interests.

Findings: Why city residents visit Torpedo Factory Art Center

- ▶ The top 10 reasons why city residents said they go to the Art Center are passive: “to wander, to see, to look, to watch...”

Table 16. Why City Residents Currently Visit Torpedo Factory Art Center

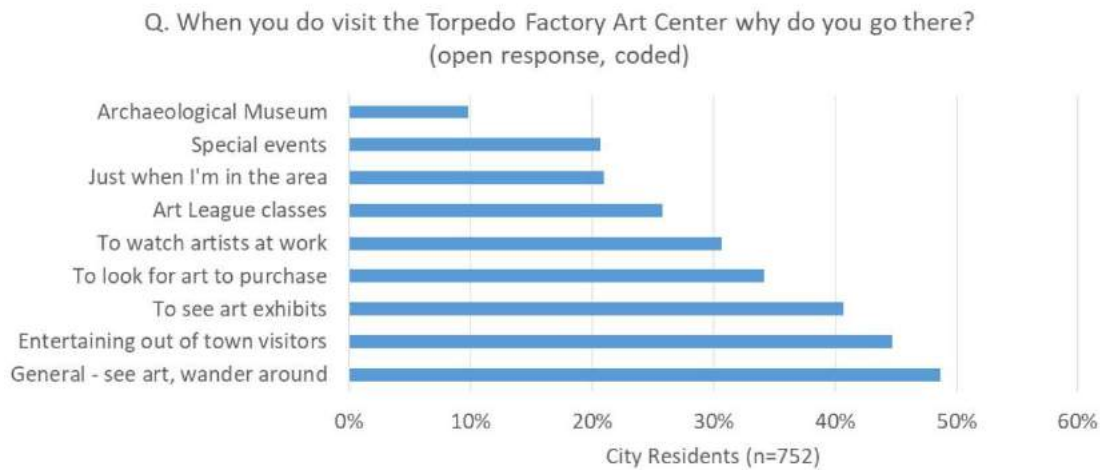

To more precisely see the differences in why city residents go to the Art Center, Art League-affiliated visitors were compared to all others. City residents with Art League connections rated every reason higher. Table 17 below suggests current offerings are less interesting to all others.

Table 17. Comparison of Reasons for Visiting Torpedo Factory Art Center by Art League Affiliation

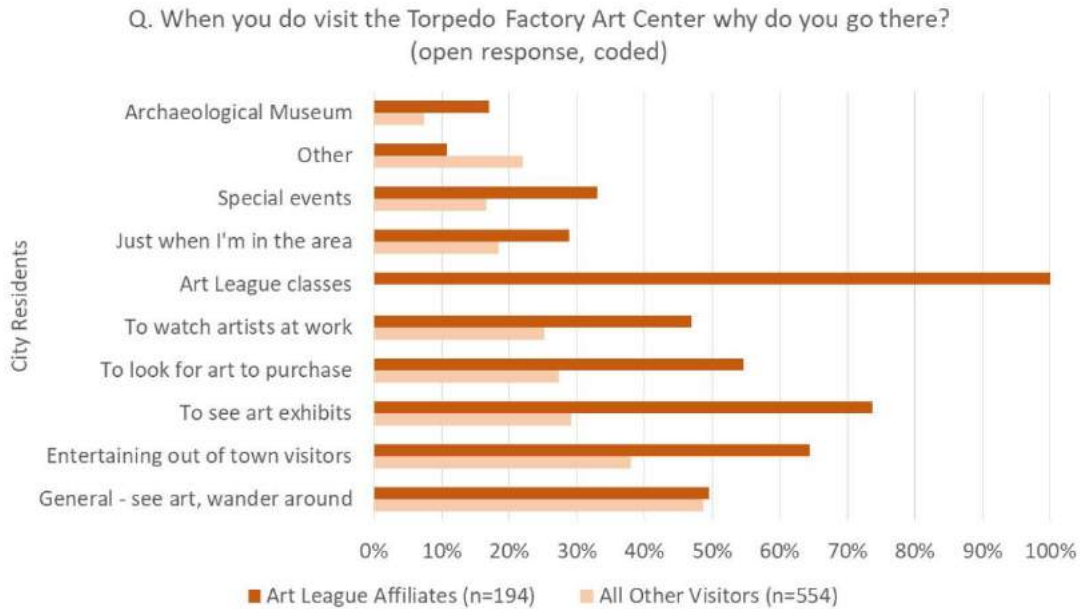

Shown below in Table 18 are the top 15 suggestions (of 40 themes mentioned) that would encourage city residents to visit Torpedo Factory Art Center more often.

Table 18. What Would Encourage You to Visit Torpedo Factory Art Center More Often?

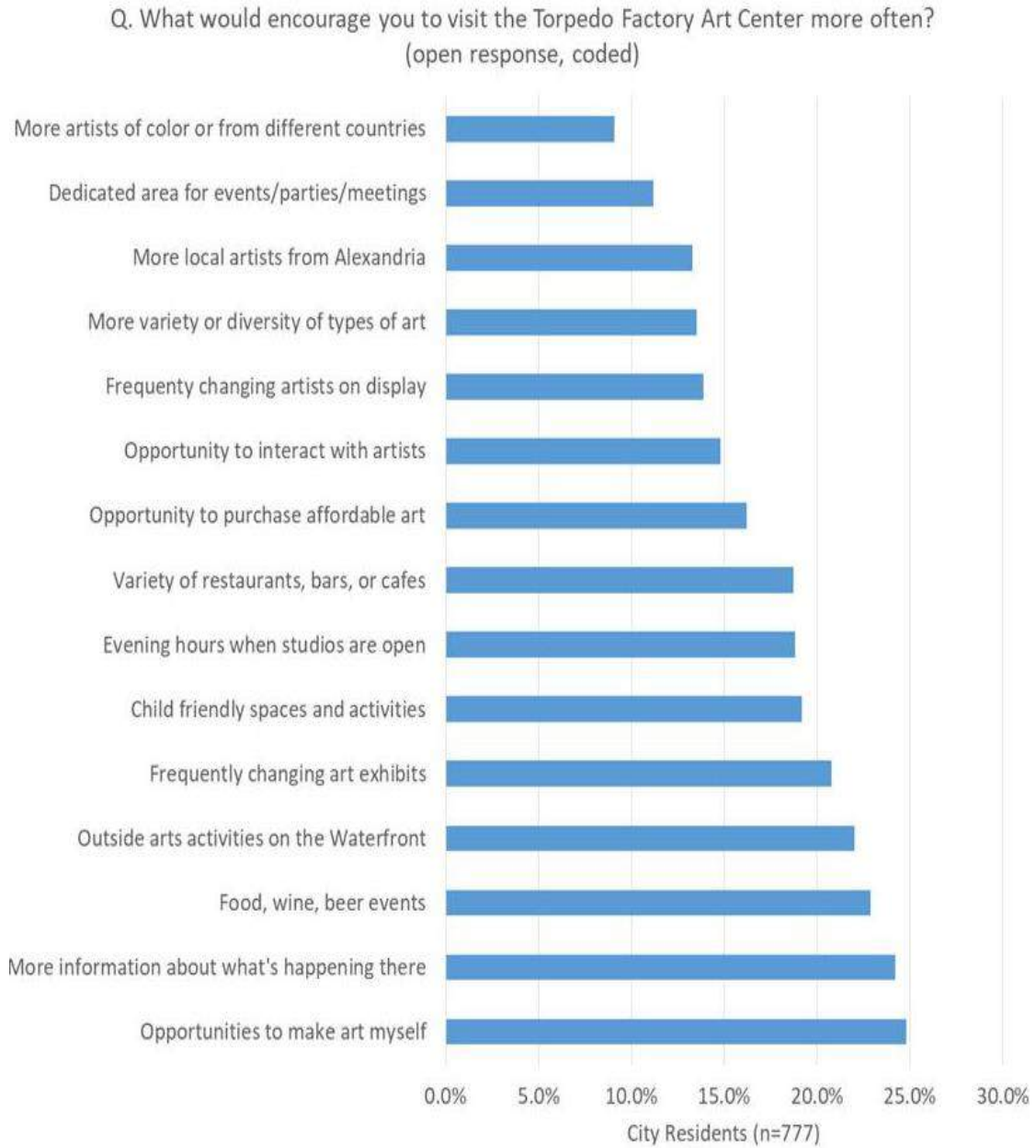

Findings: Age is a significant indicator both in terms of assessing current participation patterns of City residents and how to increase participation.

- ▶ Alexandrians age 35 to 64 are outpacing younger and older age segments visiting the Art Center by more than 3:1. Cultivating next-generation Art Center participants – especially 17% of infrequent visitors under age 35 – should be a priority.

Table 19. Current Torpedo Factory Art Center Participants by Age

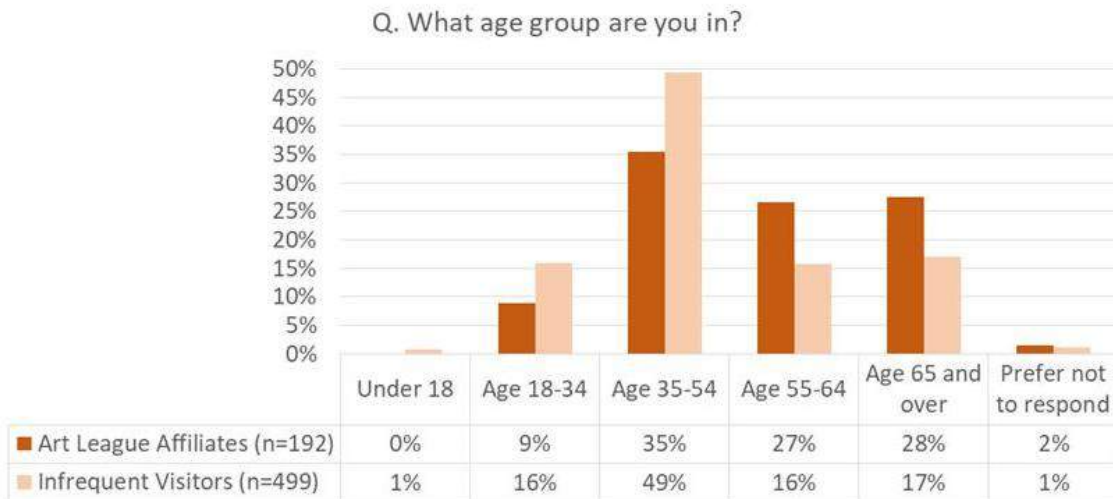
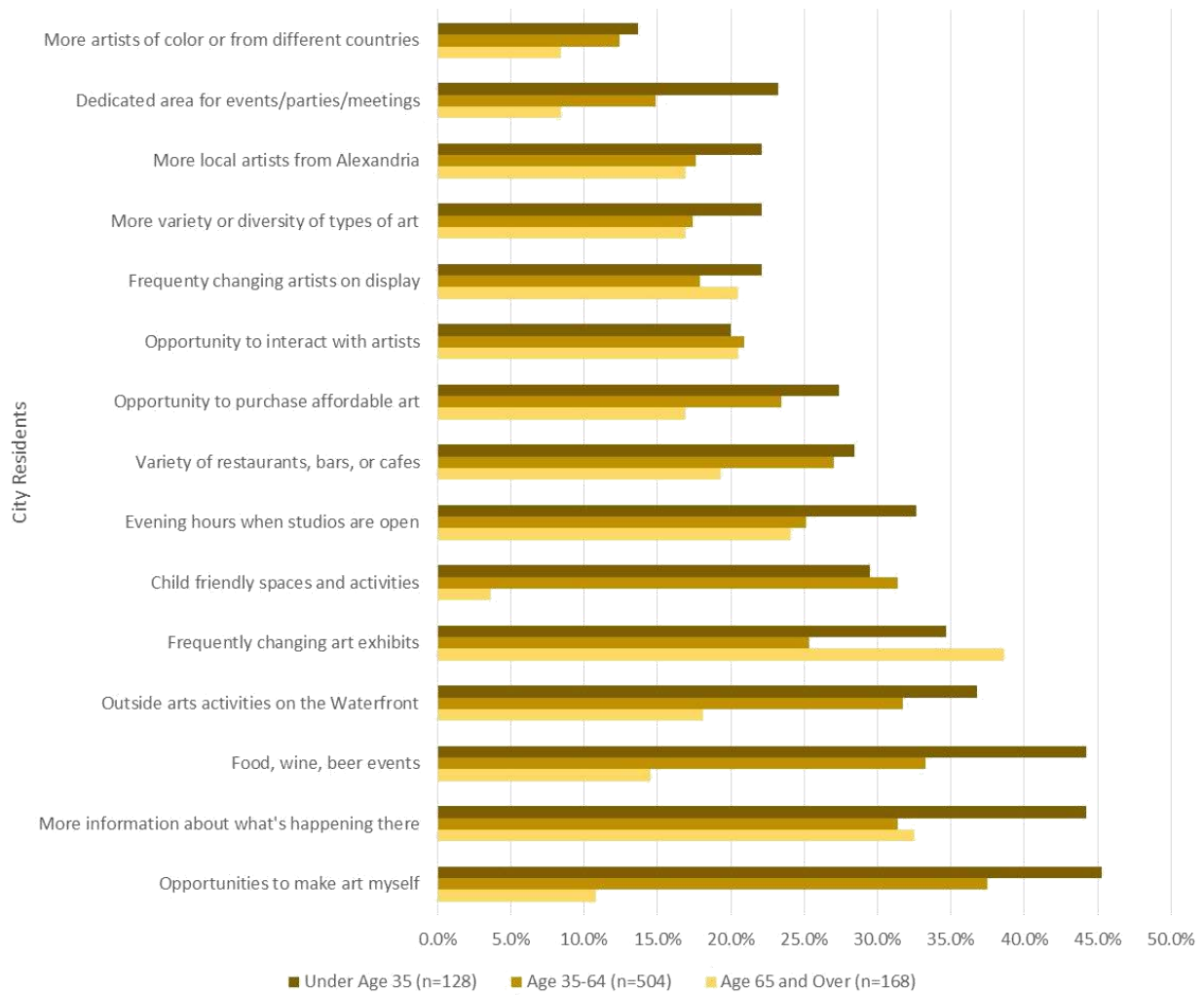

Table 20 provides data that will be key in continually refreshing and developing more program offerings to attract different age segments. One size will not fit all as punctuated by the disparity of interests by age in the four activities at the table's base.

Table 20. Suggestions for Improving Torpedo Factory Art Center Visits by Age

Q. What would encourage you to visit the Torpedo Factory Art Center more often? (open response, coded)



- ▶ 72% of City residents want programming on weekends.

Table 21. When Is It Most Convenient for City Residents to Visit Torpedo Factory Art Center?

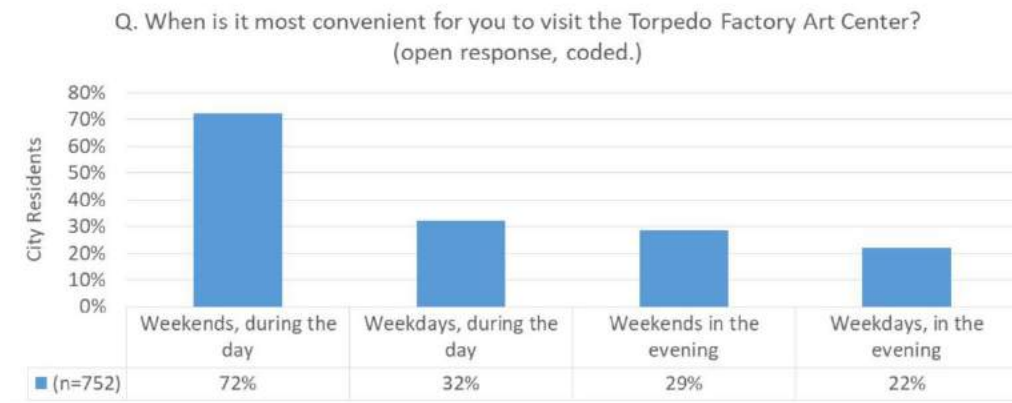

- ▶ A prime target of new Art Center participants are the 62% of city residents who are unfamiliar with Torpedo Factory Art Center, but visit the waterfront more than 7 times a year.

Table 22. Frequency of Visits to the Alexandria Waterfront

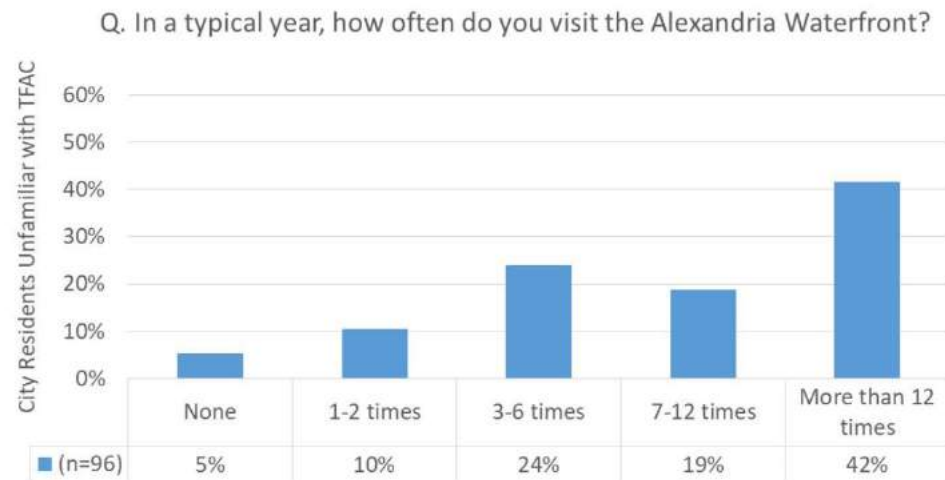

- ▶ Creating mutually beneficial, innovative programming strategies linked to preferences in Table 23 below could attract and keep even more Alexandrians on the waterfront.

Table 23. What City Residents Unfamiliar with Torpedo Factory Art Center Who Visit the Waterfront Like to Do

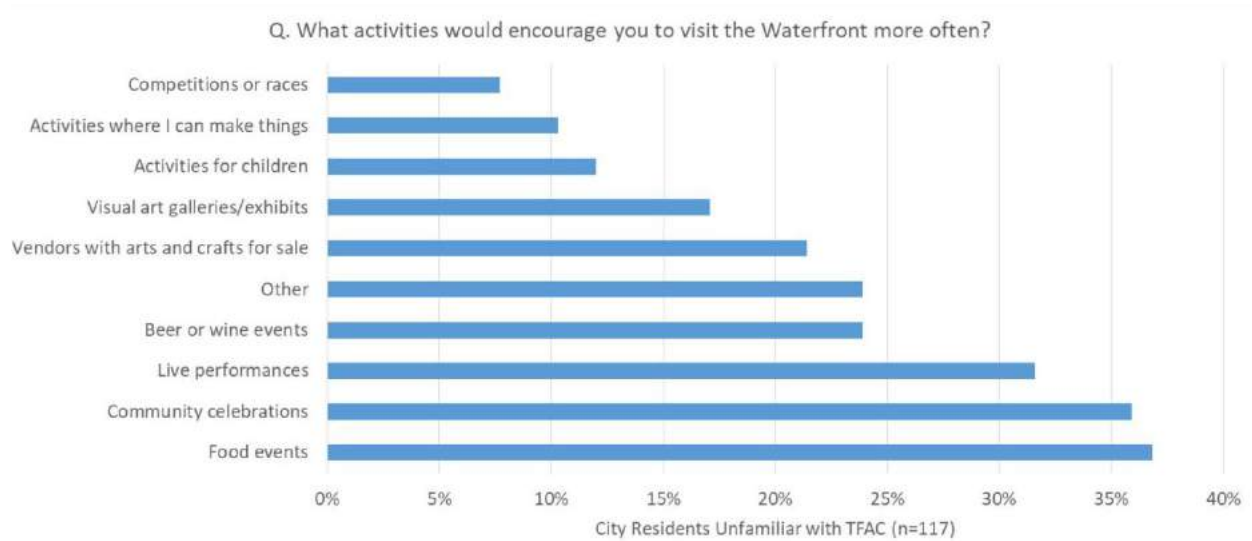

Findings: What the community of artists in Alexandria needs and how Torpedo Factory Art Center might help

Data and opinions collected from 371 Alexandria artists – those involved with TFAA and not – reveal the needs and challenges artists face.

- ▶ 42% of Alexandria artists earn some part of their living through art as shown in Tables 24 and 25 below.

Table 24. Professional Artists



Table 25. Annual Income Derived from Creative Practice

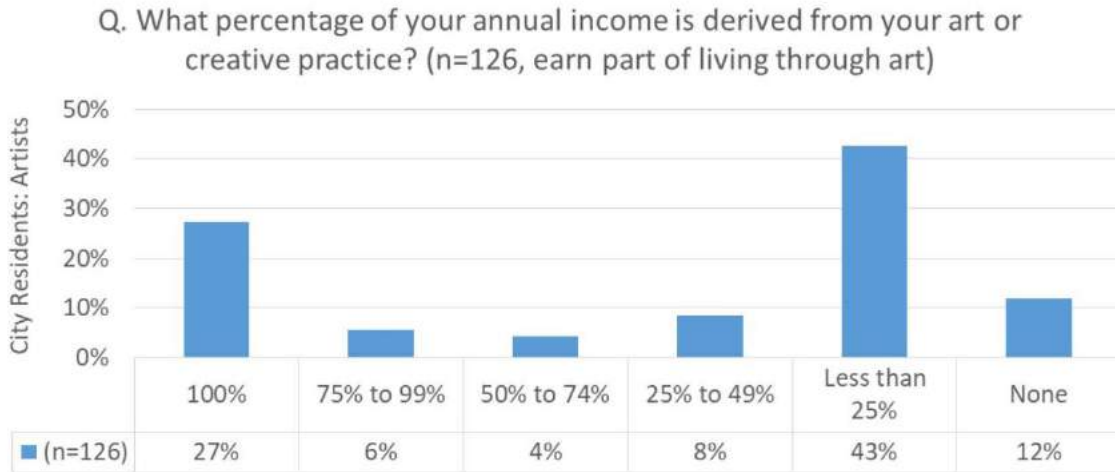

- ▶ Artists surveyed were asked to prioritize what's most important to them in regard to their creative practice. All point to increasing the ability of artists to earn their living as an artist.

Table 26. Issues of Importance to Alexandria Artists

Q. Please rank the following by importance to you as an artist.	Rank
Opportunities to learn a living as an artist	1
Affordable workspace in which to create my art	2
Resources to develop my artistic practice	3
Affordable retail space to see my art or service	4
Resources to develop my art business	5
Opportunities to connect with other artists or arts organizations	6

Table 27 below illustrates the extent to which Alexandria artists know about and are aware of City of Alexandria resources and Table 28 shows where they turn for support.

Table 27. City Artist Relationships with the Alexandria Office of the Arts

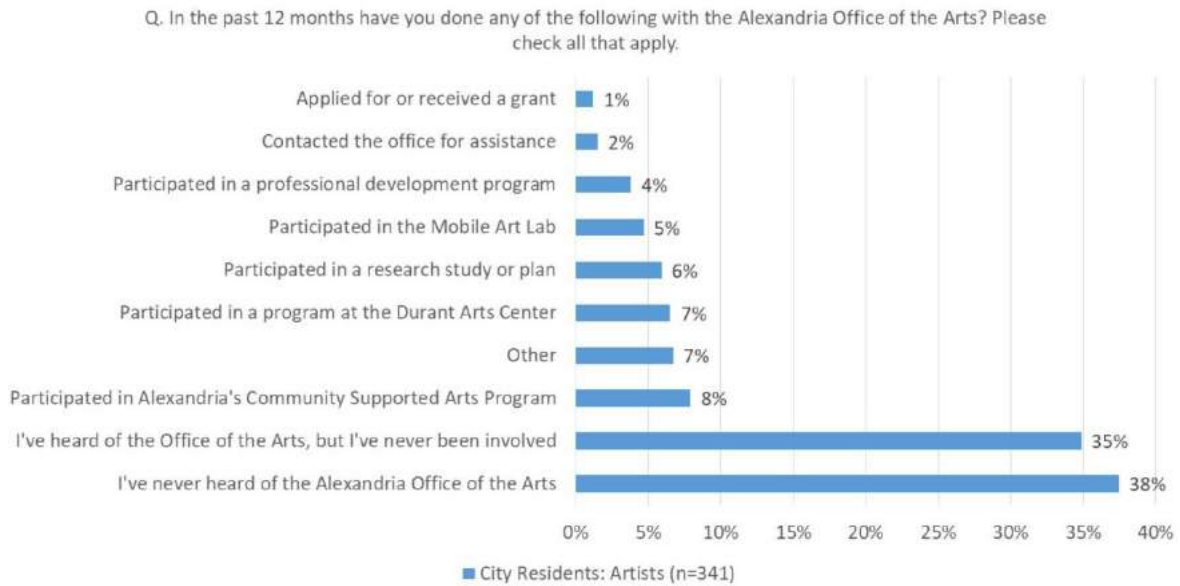
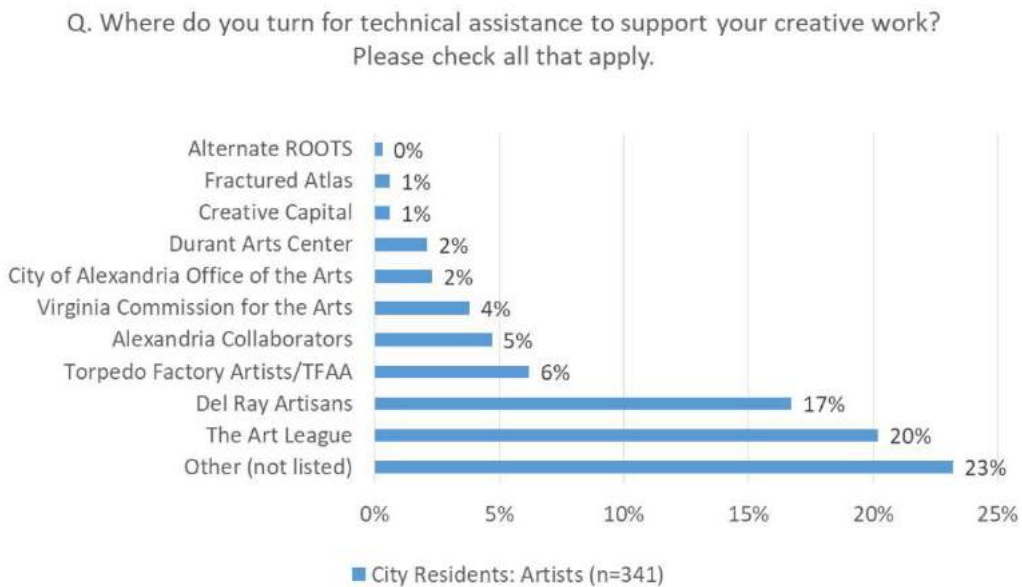

Table 28. Where City Artists Turn for Support



Types of assistance and support Alexandria artists say they need are in the next three tables.

- ▶ Of note is the high level of importance on interacting with other artists, rated second of a dozen options.

Table 29. City Artist Interest in Professional Development Services

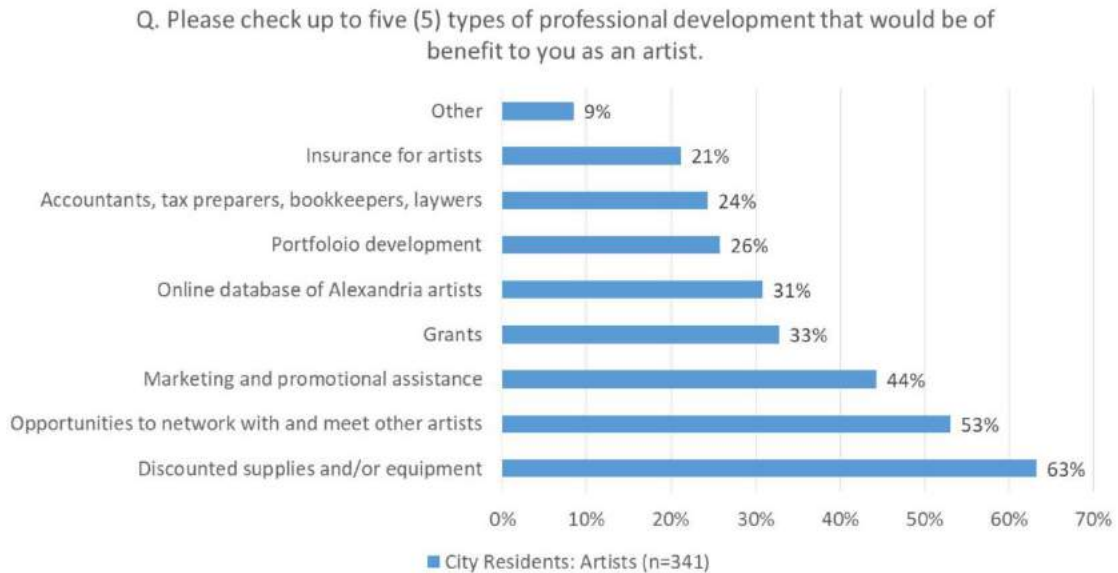
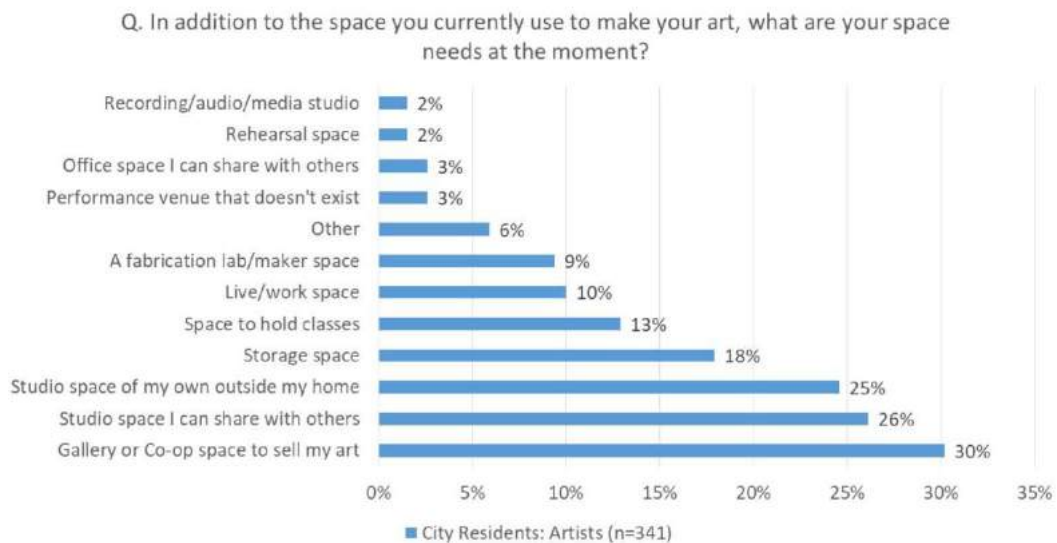
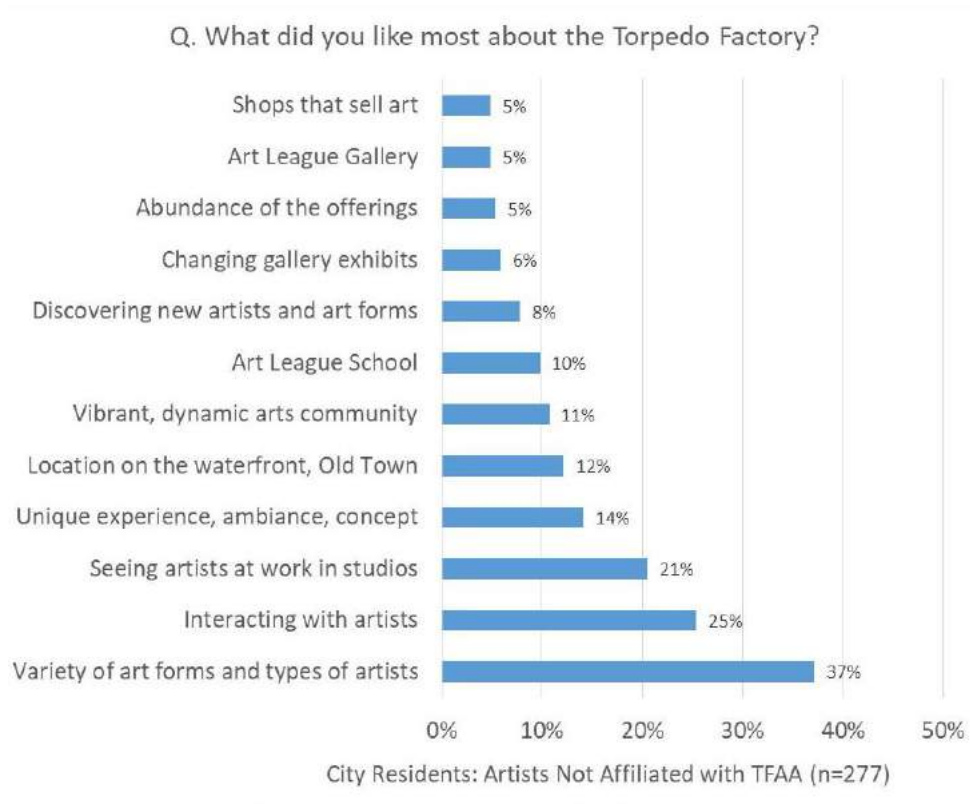

Table 30. City Artist Current Space Needs⁴



⁴ It should be noted that 74% of city artists responding to the survey worked in visual arts, while 26% worked in some form of performing art or “other” creative discipline.

Table 31. What City Artists Like Most about Torpedo Factory Art Center (Artists Not Affiliated with TFAA)



PROGRAMS

RECOMMENDATIONS TO BROADEN AND DEEPEN THE ART CENTER'S COMMUNITY CONNECTIVITY

5. Revise programming strategy.

Rethink artist and partnership selection process within the Art Center's comprehensive programming strategy for studios, exhibitions, and events to align with the refreshed mission and goals.

6. Expand programming inside the building and outside the building.

In partnership with tenants, with other Alexandria artists, Alexandria's most successful arts organizations, and other potential partners, expand mission-appropriate content that will increase Torpedo Factory Art Center participation.

7. Consider offerings and services to assist Alexandria's artists.

As part of the programming mix consider meeting the networking and professional development needs of Alexandria artists beyond what is currently offered through membership-based services.

8. Modify days and hours of operation.

Keep better pace with Alexandrians' preferences for days and times of use.

9. Strengthen relationships and develop partnerships with waterfront and Old Town entities.

Together, develop mutually beneficial ways to increase public accessibility and use of the waterfront and King Street.

10. Monitor progress of Alexandrians' participation in and opinions of programs.

- Monitor the balance of offerings for different population segments and artists of various media and artistic disciplines.
- Establish participation targets and measure success in achieving participation targets.
- Use results to continually inform programming strategy that will increase target audience participation.

SECTION 3. PLACE

IMPROVE SPACE AND OPTIMIZE SPACE UTILIZATION

This section is about revitalizing the Art Center as a more dynamic place for the enjoyment of all Alexandrians and visitors. Findings and recommendations from interviews, focus groups, and survey comments also relate to building appearance, a sense of welcome, accessibility, and ease in navigation. Also included are recommendations for the City’s consideration to optimize the Art Center’s spectacular waterfront location as a creative gathering place, linked to other activities in order to achieve wider-ranging community benefit.

Findings: Factors in place to support Torpedo Factory Art Center success

- ▶ “The City of Alexandria’s commitment to keep the Art Center as an historic cultural resource supporting the arts and artists in Alexandria,” according to the City Manager, “is solid.”

- ▶ City’s waterfront as a dynamic gateway to historic Old Town could mean resources would be available to support the Art Center’s physical plant recommendations.

- ▶ The potential for this report to position Torpedo Factory Art Center as a greater contributor to City of Alexandria’s Strategic Plan goals – Distinctive and Vibrant Neighborhoods and Flourishing Art, Culture and Recreation – is excellent.

- ▶ Collaboration with other organizations:
 - 7. Continuing Collaborative Organizations
 - Alexandria Arts Alliance
 - Alexandria Economic Development Partnership
 - Alexandria Small Business Development Center
 - Alexandria Restaurant Partners
 - The Art League
 - Factory Society
 - Office of Historic Alexandria
 - The Old Town Boutique District
 - Torpedo Factory Artists’ Association
 - Torpedo Factory Friends
 - Virginia Museum of Fine Arts
 - Visit Alexandria

- Current Season Collaborative Organizations
 - ALX Community
 - American Geosciences Institute
 - Armed Services Arts Partnership The HRCHY
 - Capital Area Photographers
 - Community Building Art Works
 - George Mason University, The School of Art
 - SIGGRAPH
 - USO of Metropolitan Washington-Baltimore

PLACE

RECOMMENDATIONS TO BROADEN AND DEEPEN THE ART CENTER'S COMMUNITY CONNECTIVITY

1. **Develop a Torpedo Factory Art Center space utilization and optimization plan that is linked to a *business plan for sustainability*.**

Once the mission, studio, and programming policies are clear, develop a comprehensive space utilization and optimization plan for all space inside and outside the building, including the roof:

- Program + exhibit spaces
- Public spaces: comfort stations, shops, food, etc.
- Rental strategies

2. **Develop a Torpedo Factory Art Center renovation plan.**

Once the space utilization and optimization plans are set - linked to the Art Center's sustainable business plan - develop renovation plan in phases.

3. **Position Torpedo Factory Art Center as an asset and helper to advance Alexandria's important public agendas.**

Link to:

- The planned \$60 million Waterfront revitalization plan.
- Permanent plus temporary public art installations on the waterfront.
- Plans for greenspace, parks, and historic preservation activity on the river, and historic preservation.

4. **Monitor progress.**

- Measure success in achieving the City of Alexandria's participation targets relative to the business plan and space utilization goals.
- Use assessment measures to continually refine programming strategy to increase target audience participation.

SECTION 4. PROMOTION

AMPLIFY "THE WHY"

This section focuses on Alexandrians’ awareness of the Art Center and how to improve it. Once the City’s plan for the Art Center as *a more sustainable place for the arts and artists in Alexandria* is set, recommendations include communicating those plans through marketing and promoting a new, more cohesive and clear brand. If the waterfront is, in fact, “a place Alexandria residents inhabit - not only visitors - and belongs first to Alexandrians,” communicate to Alexandrians how Torpedo Factory Art Center will be a primary catalyst in the City’s April 2018 announced plan to revitalize the waterfront.

Findings: What Alexandrians suggest to improve the brand, its marketing, and messaging

- ▶ When City residents were asked what would encourage them to visit more often, 24% said “more information about what’s happening there.” This was ranked second highest among 40 open-ended suggestions in the City Resident survey.
- ▶ Creating marketing and messaging strategies linked to preferences seen earlier in Table 23 could attract and keep even more Alexandrians on the waterfront.

Table 32. What City Residents Unfamiliar with Torpedo Factory Art Center Who Visit the Waterfront Like to Do to Inform Marketing and Messaging

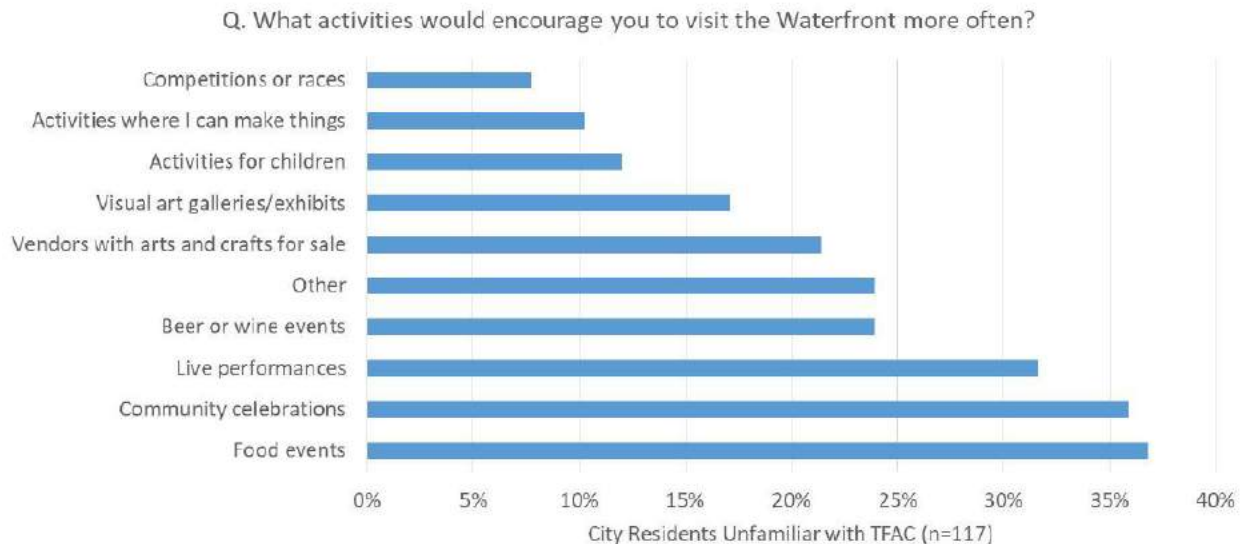

PROMOTION

RECOMMENDATIONS TO BROADEN AND DEEPEN THE ART CENTER'S COMMUNITY CONNECTIVITY

1. **Assess and refine the Torpedo Factory Art Center brand in support of the City's mission for the facility then develop messaging to drive it.**
2. **Develop a Torpedo Factory Art Center strategic marketing plan**
 - Identify specific target markets, goals, and ROI measures for marketing expense.
3. **Manage the brand.**
 - Strengthen brand guidelines and use policies, including social media.
 - Strengthen website policy for Torpedo Factory Art Center and all occupants.

INTERCEPT SURVEY COMMENTS

Other - Write In: What do you think makes it important to Alexandria's identity?
local, provides space for artist to express themselves, supports arts, space to create`
Historical/ Waterfront
Could be important but isn't. Wasted opportunity. Artists go inside, close doors, don't reach out to community, don't spread art to the community
A creative space that honors artists and Alexandria's history
history, great food,
special events - an anchor for the waterfront
no idea
A PLACE FOR PEOPLE TO TAKE COURSES AND SALE THEIR ITEMS
role it plays in Alexandria's history. it's an iconic location
diverse
Historical importance
Nice to have something to do along the waterfront that is not eating/shopping. Gives a little variety to an outing when we have visitors in town.
All of the above plus its original history
place in history of the city
live events/ A Dream within a Dream
anchors the waterfront in a beneficial way to all residents.
historic and current at the same time
place artist to develop themselves
been there forever
SUPPORTS LOCAL ARTISTS
landmark
residents and tours
creativity
Great place for young life
history, part of the culture
historic building,
historical
historical building
SUPPORT LOCAL ARTIST
nice place to take your kids to
part of the community to have these points of connection and development, as doing things personally and as a group. It's a worthwhile part of our spectrum of opportunities.
It touches people in other ways that commercialism and materialism doesn't.
history
it's popular
wonderful use of the location
a great place to have independent artist
the fact that it is there
supports local art
dk- i am new to the area

diversity of attractions to the city
History
children activities
history
Kids bathrooms
The name recognition beyond the city of Alexandria. Unique.
its Alexandria's only major art center. Its special.
Historic, local artists, great for tourists, free
Major attraction, leader in this land of adaptive re-use, supports and enriches the arts in Alexandria and nationally
Its history
It is unique. It anchors a restaurant and small shops district. It offers creative artwork and jewelry, enticing shopping excursions. It attracts visitors and continually delights residents. I was there yesterday and loved it.
Not boring and dull but effervescent and changing. Knowledgeable and interesting people work there and we can see them actually practicing their skills. It brings in lots of tourist dollars.
arts and crafts and history
HISTORY
landmark
PART OF THE HISTORY OF ALEXANDRIA
it's a very historic site, the location right on the water
history
culture
retail shops, individuality
LAND MARK
HAVEN'T VISIRE
PLACE FOR LOCAL ARTISTS TO GET KNOWN
a lot of history
easy location
location
artists are varied been there a long time
historic building, the largest venue in the city of alexiandria.
local artists, lots of things to do, you can bring children there
CLASSES, DIFFERENT KIND OF PEOPLE A LITTLE BIT OF EVERYTHING, ITS ECCLECTIC
great home atmosphere
parking
HISTORY
The art and family friendly
historical significance
on piece of culture they have
THE BUILDING AND PULBIC ACCESS
HOSTORICAL PART
LAND MARK AND IDENTIFIED WITH ALEXANDRIA
history

HISTORIC CHARACTER
its hisorical significance
history its been around
nice place to go
BUILDING AND ARTS
HISTORY/ DIVERSITY OF THE ART
PLace to buy rt
NEVER BEEN
interesting place intersting history
ART ACTUALLY DEFINE A CITY PLACE THAT HELPS ALEZANDRIA
NOT SURE
education for our kids
INTROSPECTION OF DC AND SURROUNDING AREAS
bringing art culture to the area
offers a sense of community
SHOWCASE DIFFERENT KINDS OF ART
history of munitions factory and good it was turned into something else. saves money. from what i know they have things going on there other than visual art
historic
CITIZNS
it is historical
it can draw people like a museum. i like the archaeology department
its good to be located in one space
NOT SURE
brings in local artists
NO IDEA
place to take kids and a landmark
place for people to meet and experience the culture
history
adds culture
good for working artist
I DON'T KNOW
history
landmark important
old town
nothing
i think of alexandria as a community of communities and the torpedo factory is where they can come together. it is a good place to bring visitors
large structure important peice of real estate. historical signifigance
historical and place for kids
culture
and all the events
people like it

the historic part of the city that inhabits the waterfront.
local artists/destination on the waterfront
Community art, inspires you
Fabulous art, supports local artists
tells the history of the city
great place to shop
brings art to alexandria without going to DC
history
history
typical of the public
been around a long timee
it has always been here
Don't want it to go away because part of Alexandria's identity would go away.
culture
world war2 take family
not sure
dont know
DONT KNOW
good displays
NICE MAGNET FOR CREATIVE THINGS
a fun place to walk around - can bring your dog
old town, alot of history
one of a kind/structure
It's a landmark
different families reunite
showcase
to see artisan merchants
photography workshops
variety of art
history
carries legacy of the history of Alexandria contributes
Brings culture/Adds another dimension to who we are as a city
History
Local artists/Art Leage
Been there so long/icon in community/art important to city's identity
Historical marker of the city. Good community place to host events or see art.
it is a unique instituion for the city. It is a hub for international and other parts of the U.S. visitors. Its visitors spend money there helping with the economy.
It bring the community together and helps preserve the history of this great city.
Location of Torpedo Factory at river lends itself to tourism, the history of it and the artists that are so varied.
History
Not exclusive to binary genders/simultaneous competitive and not competitive for space

Antique feel fits old town/history
locally produced art, emphasis on art many cities lack, historic building, multipurpose, landmark
sign that Alexandria supports the arts
history
individual artists that work and sell right there, made by hand locally, creative
Important historical sitey
Offers a haven for a cup of coffee or special event
Adds culture
Something to do
1st place to visit mixture of history and art
Community/artistic expression
History of the tfac
Community
Building
History
supports art
Artwork is reflective of Alexandria's history and talented artists. Archaeology is well placed for connections between citizens and our archaeology history
No opinion
Public spaces/outlet for artistic expression they might not otherwise have
Art as focus for visitor to Alexandria and artists
torpedos, the water, a destination
soul of alexandria
great place to visit w/out of town company/good place to purchase gifts.
Not sure if it's important
great place to visit w/out of town company/good place to purchase gifts.
historic/local artists
public space on the water. access to bathrooms. strong "art" prism.
Wonderful
Signifies a premier culturally oriented population which values art over profit
Different events & venues
History and contribution to the war efforts
Display are for artists. performance space, history of factory.
Cool place to go. Attractive. On the water.
It includes so much of the history and also provides a place for artists to work and display their works.
History of building. Art is a part of the Identity of Alex.
Cultural attraction
Its history not its current use.
the historical aspects of it
historical items
The land mark
DIVERSITY
not applicable

the history is exhibits and the history of the torpedo factory
its history, its potential, it could be alot more than it is and a place to gather
old town
HISTORY
a nice social place to see
something creative , started years ago. i love to visit. i have spent monely there, it has quite an attribute to the city
THE WATER FRONT
HISTORIC LANDMARK
nice there
HISTORY AND LOCATION
brings people together
DONT KNOW SINCE I ANSWERED THE OTHER QUESTION AS NOT SURE
LOCATION
THE BUILDING IS IMPORTANT AND YOU CANT TEAR IT DOWN BECAUSE THE FOUNDNATION IS BUILT THERE
HISTORICAL
any time you have art in an area and people can look and buy it it just makes the area better.

Other - Write In: When you visit the Torpedo Factory, why do you go there?
friend that is an artist
Use the bathroom
Classes for my children
Wish there was more reason to go, more interesting events, more change to the arts and artists
Kids events
to have fun
SUMMER TIME TO COOL OFF IN THE AIR CONDITION
history
want kids to be exposed to it
use the bathroom when at waterfront
it's an interesting third space. Having a library satellite branch would be awesome here. So would a maker space.
nice place to be with friends and learn
FOR HUSBAND
SEE WHAT'S NEW
to take some art classes
to shop
gone to see it not to buy
See artists
to walk around, to visit the shops, to look, to look at the water
location restroom waterfront
bringing friends or relatives
SEEING THE WATER FRONT PIER
land mark
went with friends
looking for art
new an artist
the shop+restaraunts
see different art available
no
I work one block away
visit waterfront
date or visitors
just a stop off place when I'm riding my bike
to rake my kid for the art
looking to buy objects i like
food court
to see new artist see waterfront
TO LOOK AT THE ART
JEWELRY ENGRAVER
really good seafood restaurant

theater event,
TO LOOK AT VENDORS
TOO SEE VARIOUS ARTISTS
to take your grandchildren
EATING
relaxtion and social meet up
curiosity
I AM NOT PERSONLLY INPRESSED WITH THE ART OFFERINGS
SHOP,AND HOST VISITORS
to get kids something to do
CLOSE BY WHEN HE GOES TO NEARBY RESTAURANT
see whats there
in the neighborhood want to look around
JUST HAPPEN TO BE IN THE NEIHNORHOOD
DON'T REMEMBER
to see what activities they have
in my neighborhood and its something i want to see. i like to support it.
place to bring my grandchildren
look at the art and see if anything is new in the archaeology department or if a friend has a new exhibit
to accompany others
a fund raising event
enjoy mtself and take my kid
history
shops
to see whats new
visiting workig artist to see new art
quality time for her & dad
TO SHOW VISITORS WHAT WE HAVE HERE IN ALEXANDRIA
to take others to see
whats new
activities for children in old town
to look at art
Relaxing
Classes
My kid enjoys seeing the art and artists
Entertain my kids. Open area, attractive art, fun atmosphere.
bathrooms
nice to have it in your backyard
school related function
to see what artists are doing- working on
My child performs there with his school, John Adams ES
walkng around to vent
to watch my kids perform

ON THE WAY WATERFRONT
OUTING WITH FRIENDS, DINNER
to see what is on display
to see the stores, art, pictures, archaeology
TO TAKE OUT OF TOWN VISITORS
the river view
have had jewelry made and for sightseeing take my guests there
just when i am downtown
Good location for first date
weather
Environmental reasons/to market my goods talents
A part of the experience in old town
Whenever i'm around I go in
open print studio, buy supplies
inspiration, talk to artistists
Walk through with toddler kids
Kids' events
cup of coffee with friends
See what's new
See what's new
Lunch at Eats Place
Bathroom
Classes
Bathroom
and shopping
shows our heritage
to go with friends
for events or to take tourists
just to walk through it
HISTORY
MY FRIENDS WANTED TO GO
lectures
TO EXPERIENCE ART
I'll go to volunteer or just when I want something to do.

Other - Write In: What do you like most about the Torpedo Factory?
so many things to explore there
Not much. Wasted potential.
Archeology
Almost nothing
Watching artists but most are never there even when I visit during business hours.
art and food
aet safari and other family events
open welcoming space
Dog friendly
Lectures
the flower arranging demonstrations are great
SUPPORTS LOCAL ARTISTS
NOTHING SPECIFIC
nothing
people watching
no pressure to buy
vendures, historic information about the torpeodos
variety of shops, its all local
MY WIFE LIKES MOST OF THE ART WORK
open to the public, place where people can meet, a real part of the community
SEEING PEOPLE WITH THEIR OWN ART
it makes us stand out
diffrent types of art
glad local artist have a place to do thier stuff
that it made topedos in the past and that it is a industrial residence
seeing differnt kinds of things availbale-
no comment
the art gallery
family days
Socials
Great cultural center
All of it
Diversity of artistic experience
Open to all
Entrepreneur/support local artists
Conveniently located. It links the past and present aspects of our community.
lighting open space
NOSTALGA
local art
grat local art grat place to take visitors
p[eice of the history of alexandria
LOCAL CRAFTS
HIGHLIGHT AND SHOWCASE LOCAL ARTIST

varied artists
ART, IM A ART PERSON
ACCESSIBILITY TO THE PUBLIC
ice cream shop
HISTORICAL SITE COMBINED WITH ART
VARIOUSS SHOPS AND BOOTHS
everything
being on the water.
The eviorment
art building is fascinating
CONVIENIENCE
different
SHOPS ON THE FIRST FLOOR
seeing whats new
DON'T GO THERE
variety of things they have
its accessible and not overwhelming
children can absorb the environment
i like the historical aspect of the building with all the different levels and the different rooms
nothing
design and layout for the artists to do their projects.
the whole experience
talk to artists visit archeaology
EVERYTHING
dont go
see how far come in dwevelopment
its just kind of there
supporting local artist
QUIET
the name
INTERACT WITH ARTISTS
diversity of the artists
interacting with the artists. it is there and it is unique
local artisans. free admission
pleasant experience
brrowse around and see what the artists are doing
the art studio
convenience
Interact with artists, buy art & know who made it, love the Art League and how they support artists
galleries are nice
Interactive
Interact with artists
My kid enjoys it
Bathroom
just like it exxspecially for my son who takes dates there
not sure

nice to look other families are there
the large open space
nothing really
SERVICE
CLOSE TO WATER FRONT
the displays
PLEASANT TO GO SEE EXHIBITS
exhibits
the variety of stores
everything
i like the russian jewelry maker
restarants or cafe
bathroom
exhibitions
Variety of art activities
supports local artists
Everything. Loved it.
WWII History
Events that are held there.
special events/holiday celebrations
supports artists
open studios, engagement, architecture
i dont like anything
Arts and culture
Layout easy to navigate
Live music events colorful
Cafe
Supports arts
Eclectic nature
No opinion
Just like having it there
community gathering place
architecture
Open. Welcoming space. Not a restaurant or commercial space expecting \$.
Meeting and interacting with artists
Everything. Loved it.
Indoor space to enjoy time browsing and looking at art.
Active present artists
Seeing the artwork and learning about our history.
Not much.
It provides artists a great place to work, display and sell. This is a very important support by the City. I go out of town to find a similar space.
lots of creative arts
seeing some of the art
being able to walk around the piers and the restaurants right around there and the art and shops right in the torpedo factory.

and the history and can actually buy the pieces there
its a gathering place around art
i think its history; the fact that it was a torpedo factory
the experience
THE HISTORY
I like the fact that it's there. But it could be better. It needs more.
galleries
ITS UNIQUE
I DONT REALLY LOVE IT
You can submit art to shows. It's not like a museum that you'd find in DC. The Torpedo Factory is more like you can get involved.

Other - Write In: Was there something specific that would have made your visit to the Torpedo Factory better? Or if it fell short of your expectations, how so?
No
I'd like a centralized place to bring guests to purchase--aka a big gift shop area where all artists could have some pieces.
Would be nice if there were more family programs, concerts, etc. Also, art is often the same, expensive, and sadly a little tacky. Would be nice if there was a higher caliber of art, B&W photography that is not just DC scenes (hotel art), and/or local crafts. Seems like a cross section of art that is a bit dowdy and that which is very gaudy.
It would help if the artists were in their studios. Very few artists were present.
The location is ugly and feels like a school gym or an abandoned ship tanker. Lacks creative energy. Without artist demonstrations and interesting exhibits the place is boring and not worth staying.
Art/Artists more current, more engaging, more dynamic
customer service
ELEVATORS COULD BE FASTER
more children's events
no
had a wonderful experience there
MAYBE IF MORE OF THE ARTIST OF WERE PRESENT WHEN I VISITED
walk around with a glass of wine
not made aware of tours
perffect
Gift shop super expensive
the city neglects this facility. It shouldn't be solely on the artists to come up with the cash to maintain the building. The city needs to shell out to get the water changed so that the yacht club doesn't use the water to wash their boats for free.
no
NO
it was better than i thought it was going to be
NOTHING IT'S PERFECT
more activities, more like a social function.
food
gone in once
IT WAS FINE
support friend
open to community
more shops, for eating and drinking, book stores
more of a rotation on the artist. would like to see a variety of artist.
real cafe indoor and outdoor
nothing
EVERYTHING WAS GOOD
artist not welcoming need more places to sit
LACK OF PARKING HURTS THE TORPEDO FACTORY

ARCHEOLOGY THERE AND MORE RESTURANT CHOICES
meeting with artists
Making things more public about the opportunities there, supporting the street musicians
MORE HISTORY AND SPACE
no improvements
more culture
nothing specific for me
nothing
depends on the arstist
nothing would have made it better
every was ok.
nothing I can think of
nothing
no
Last time we tried to go it was closed - no idea it closed so early on a Saturday evening
Upgraded bathrooms
More lighthning
Convenient Parking
I think it's a great location for Tourist and the community
I liked it
Parking
More signage for artists
Cheap easy parking/maps of stores & restaurants nearby
No. Some members of the City Council & Planning staff appear to be openly hostile to the Torpedo Factory. I wish they would stop this ugly behavior. Radical change is not what is needed. It is not just another cafe site.
parking
NONE
everything i expected
met ep[ectations
MORE INTERACTIVE STUFF
nothing really low pressure place to shop
nothing
cant make it better
nothing
needs something to bring the art and history together and make it more accessible to tourists
NONE
NOT ENOUGH SPACE
not all the stands were open
nothing
no response
everything was great
NO I ENJOYED IT

NONE
more vendors
nothing
parking
I wish their classes were a little cheaper, and a lot of them are during the day when I work.
THERE WAS NOTHING NEGITIVE
UNSURE
just okay
NO
no
nothing i can think of
not quite sure wat your gonna get
NO
NO
NOTHING IN PARTICULAR;
NOT MY TASTE IN ART
no
NEED TO OPEN THE COFFEE SHOP
IT DIDNT FALL SHORT AND I CANT THINK OF ANYTHING THAT WOULD MAKE IT BETTER
nothing
NO
ENJOYED IT
no
like it remind him of a mall
NOTHING
NOTHING
NO
need to paint on the cieling it is falling all the place
no
parking
NO PROBLEMS WITH ANYHING
I CAN'T ANSWER I DON'T GO THERE
no
SUPPORT THE ARTISTS
no
i cant recall
did not fall short of my expectations. ive been there berore and knew what to expect
it was fine
NO IS FINE
i cant think of anything, the artists are pricey
more of the historical info
no - it was fine new experience
NO

timed program free and interactive, not enough benches, musicians playing in the hallway
more special sales
a bit of music
NOTHING
NO
no
nothing
nothing
evrything good
better gift shops / more parking
DON'T REMEMBER
young didnt understand
I DONT HAVE AN ANSWER FOR THAT I GO TO LOOK AT ART I DONT THINK THAT WAY
everything is perfect
nothing
it has never has fallen short of my expectations. it is always different
all museum very nice for kids
i dont think so
it has never fallen short
no
Food trucks/lower cost food options
No
Haven't been in over 10 years
less sales and more artists working
New art
Directories, schedule of events
Espresso bar
I would go more often but since parking is a nightmare and expensive, I now look for art classes and sales elsewhere
more artistic education would be nice
Incorporatee indigenous art from immigrant communities in Alexandria.
nothing right now
nothing
dont know
nothing parking
nothing
it meets my expectations when i go there, have exhibitors on the history of the city
no
NONE
NO
christmas display, enjoy history
no interest in art
NOT SURE / NO COMMENT

NEED TO UPGRADE AND BRING IN MORE STUFF
ENJOY DIFFERNT ART FORMS, THE PEOPLE, THE ART, WOULDNT CHANGE ANYTHING
NO
can't say
NO
NOTHING
ITS OK
nothing
dont know
NO
CLOSES WHEN IM THERE
making it bigger
FRIENDLY TALKING AND RESPONSES
more concerts from schools
no it was a good experience
never visited art
the soffee cart is only seaonal
parking is a pain
it has never fallen short. there is always something there that is different
classes on light room processing
Artists need more customers, service focus for all populations
Location is fine but parking is a hassle
exhibitions and history
More detail about WWII/Education on factory
Needs to be more vibrant to engage attendees
"homegrown" art
Events
if I could find what I needed
Artist not very engaging. Should have film.
Packages with other places
No
Nothing negative
Juried, rejuvenated, term limit, members be available for other functions, competitions to get in
reasonably priced art classes
Rooftop bar/restaurant, later hours on weekends
Didn't fully understand the flow of the building, wasn't welcomed or introduced to the space. No on ein the gift shop and in some studios to be able to make a purchase.
Building is old and not very appealing inside
I would attend event if invited
none I love the Torpeo Factory
bathrooms need an update
lack of parking nearby, accessibiity issues
Parking

Restrooms on the first floor are closed for the first hour of the day
Events
Crowded on weekend/interactive activities
Advertising and marketing
Advertising/marketing
Sorry to see the coffee shop go.
First time/buiding easy to manage/good experience
Its great but needs more funding to upgrade the facility
Modernize/Upgrade
Modernize/Upgrade
There seems to be a gap between people on King St and Waterfront for restaurants etc and the people going inside the TF
Cafe in TF is limited. Consider expanding it to include outside (dock). Wider selection. Would be great to have expanded hours before and after dinner (6-9p)
Art opening, 2nd Thurs.
More live performances like the Edgar Allen Poe piece.
Was a bit clueless about where to go but still fine.
live entertainment
Term limits
NOTHING
more handycap assesable
nothing paticular
PERFECT AS IS
the bathrooms could be improved.
NO RECENT ACTIVITY
it they had handicapped accessibility, handicapped bathrooms
longer hours, more edging art
i think it is fine as it is
stay open later
NO ISSUES
everything is fine the way it is
TOO EXPENSIVE AND DOESNT HAVE A HISTORY SECTION ABOUT THE FACTORY
ITS PERFECT
NO PROBLEMS WITH ANYHING
The organization as a whole feels somewhat mediocre.
it does good doesnt need changes
PRIVATE CLASSES, PUBLIC EXPEDITIONS NEED TO BE EXPANDED
no
OFFENSIVE SIGNS AGAINST DONALD TRUMP ON THE 2ND FLOOR
MEETS ALL MY EXPECTATIONS
Not a lot of programming or events that try to draw in a younger crowd. Programming and marketing that draws people under age 60.
not advertised much

Other - Write In: What would encourage you to visit the Torpedo Factory more often?
More events centered around a younger demographic. advertising
Bring back Art on the Rocks (Art on Tap is not as fun, especially for non-beer drinkers)
Definitely needs more diversity in the artists and the art on all levels. More activities for families, places to gather, have a snack, etc.
Better cafe
More events
Kids art exploration events may two times per month/regular reliable shop to purchase local artists work
More artists there.
More events, especially art demonstrations. Art gallery showings with wine events. Weekend events for school age children that do not require sign up. More demonstrations by "maker studios" such as wood fired kiln
Larger variety of art, greater change over of artists, more diverse art, cafe
nothing
IF IT WAS A REGULAR ART GALLERY
more events
parking cheaper or validation
time
later hours on friday and saturday
more advertising. more events, an open house.
nothing
Performances or activities that encompass other art forms like dance, music, theater.
shceduled events there
entertainment shows and preformances
a maker space and Parks department upper management that understands their mission citywide
Advertising/website/flyers in old town and around the city
when I have time
MORE PARKING
better parking
for people over 35
dont know
more classes, better parking
make me more interest
a museum would be nice
more special events
weather warmer
more planned events
more parites
good cafe, musical events public invited
more kids events
NOT SURE

MORE PARKING
nothing
IF IT WERE OPEN LATER ON THE WEEKENDS
special events
more information through the mail
NOTHING
more time to visit
more events
more special events
its not my thing like to watch sports
free parking at certain times and better handicap space my wife and i have handicap issues.
nothing more to add, it is just a matter of time availability for me
promote it more- social media, and direct mail and tv
i cant think of anything
Artists have hours they have to be open. Some open some closed, no consistency with hours/artists.
Art History and teaching series
More advertising
Living closer
Able to bring my dog
Free events, yoga/sumba events/happy hour
Dog friendly events
If I had more money
Cheaper parking.
MORE PERFORMANCE ART
nothing
more events
location parking
free coffee, or iced tea
themes and events
I like archaeology, so if they had a display of things they found over the years
ADVERTISEMENT
a couple times is fine with me
holding more events rhere
better place to eat and shops stay open
have regular events
DONT KNOW
coupons
FREE PARKING
reminders to go
offering activities
more time off
UPDATED EVENTS
MORE OPEN HOUSE EVENTS

nothing
more theater events
more seating, way to get food and enjoy it while you're in there.
nothing
diversty of exhibitbs
exhibits
MORE COMMUNTIY GATHERINGS
NEWSLETTER OF EVENTS TO KEEP ME AWARE OF WHAT IS GOING ON
NO ANSWER FOR THAT
just my distance
Develop a collection from other places or museums.
if included musical events
PARKING SPACES
cheaper parking
NOTHING
MORE PARKING
cant think of anything
havent been in a while
THERE ISNT ONE SPECIFIC THING
NOTHING
dont have an answer
ID LIKE TO KNOW WHATS THERE
not sure
nothing
BEING AWARE OF WHAT HAPPENING THERE
NOTHING
NOTHING
nothing
MORE PROMOTION
free classes
more art classes
EASEIR TO PARK
more advertising
live entertainment
i dont know
nothing
little closer and a little more convenient parking
talks by artists or classes
not alot wrong
ADVERTISING
more convient parking
more time in schedule
not sure

classes
better parking
I DON;T KNOW
IM REALLY TOO BUSY TO VISIT THE ART CENTER
dont know
nothing
need to know where it is
i there were more events there
more public displays
when we take trip to waterfront
opportunity to look around
featured events and artists, galleries
walk around
They have an archaeology room. I would like more history, like a history room. Or they could expand the archaeology room as it's pretty small to add more history of Alexandria to the space.
Parking/seating outside comfortable
Time
Better contemporary programs
More free personal time
winning the lottery
better parking
its nice to have a place in teh city that isn't unindated with small children - try to keep at least one place that way!
Types of exhibits that are interesting and perhaps connected to social justice movement.
depends on my life
parking
nothing
kd
Public calendar
Turning the Torpedo Factory into something else, like bars/restaurants/venues
Art attraction engaging/music
dont know
MORE SHOWS
more history
HISTORY
MAKE IT MORE INTERESTING
STICK TO YOU ORIGINAL OUTING ACTIVITIES
BETTER PARKING
and that i like
MORE ADVERTISING FOR ACTIVITIES
THE ATOMOSPHERE
SOMEONE TAKING ME
nothing

i like to go in the summertime
NOTHING
ADD MUSIC INSIDE AND BEVERAGES
none
BEING ABLE TO WALK AGAIN OLDER INDIVIDUAL
more school concerts
better parking in old town
parking is a problem
annual sales prices are high
better health and bringing in major artists.. for special exhibits
more events
More ethnic diverse artists/activities
art from different cultures
Advertising/More history
More social events at small fee. Outreach to people on West End and the city for socializing with food/drinks.
Special events couples, singles and families
Visiting relatives/friends
It is so dead and appears like nothing is happening in the building
Events for singles, couples and families
More time
Festivals/open studios/arts and craft fairs
More time
Events
MORE AVAILBILITY
online category searchable database
More time
Transformational not just transactional. Artists supporting/advertising other art events
N/a
Time
More performance events
New artists
More awareness of events
hands-on demonstrations
More free personal time
More events
Parking
rooftop bar/restaurant
Accessibility. As a person relatively new to Alexandria, I know that artists work there but it seems like an office building for artists. I would be nice to show how to access the artists or have screens at street level with live streaming of the artists making their art.
It's time to evolve and make the TF building a market that is open daily. See Reading Terminal Market in Philadelphia and Mercato Centrale in Florence, Italy for inspiration.
if I was invited to function or social occasion

Art-making activities, music in the open space
better cafe with outdoor seating
More focus on history
I visit close to once a week - don't need more of an incentive - it is good just the way it is
Advertising marketing
Not much
TP needs to do a better job of informing the community of its activities
Longer hours/more artists working
Diverse performances/arts
History of people in the war time relative period of the TF
Open studios
public outreach/notification of exhibits
historical events
performing arts
performing arts
Maybe have book talks by authors. connect it to king St crowds more! more signs/publicity.
Being in town more
More events; community based art shows. kid events.
More exhibits from local artists
Themed events-maybe talks or drinks or over 50's mixer
Time
events
Diversity of artists
Changing artists
emerging artists, cutting edge arts & installations, resident participation making activities
More engaging events
Rotating uses, business or art exhibits
no
SPECIAL EXHIBITS
more handicap areas
advertise a little bit more
NOTHING
FREE TIME
upgrade with more handicapped facilities
longer hours, nicer place to sit for a meal and edgier art
more displays about its history, old photographs of alexandria are always interesting
nothing
AVAILABLE TIME,MORE MONEY TO KEEP FUNCTIONING
nothing
NOT A LOT
DOOR PRIZES AND RAFFLES
NOTHING
NOTHING

More interesting and sophisticated offerings.
cant think of anything
nothing
I DONT REALLY NEED ART
VISIT FREQUENTLY ENOUGH
NEED MORE ADVERTISING
Free events or low-cost events.
if they advertise more

Other - Write In: What types of activities would make you visit the Waterfront more often?
mostly for restaurants
Women
Better parking
Relaxation
Relax, look at water and boats
lgbt events
Gay Pride
depends on when i go
RELAXING
veiw
unsure
I like the restaurants down there.
cost is cheaper
more outdoor events
brunch with alcohol, mimosas
N/A- always there
Boat rides
walking
football
NOTHING
Walking on waterfront
Just to visit the waterfront
I like it like it is
Boating activities, regattas
Vegan food options

Is there any other advice you would offer to the City as it plans for the Torpedo Factory's future?
Love the arts, but it can't come at the expense of providing critical services and education to the youth of Alexandria
I think that the hours are the main reason we don't visit. They are odd. It would be fun if there was an arts festival in the torpedo factory and more events for city residents to socialize, purchase and support art and if the artists worked with ACPS and community programs, like The Campagna Center. When I lived in DC, I went to many arts events at the Corcoran and was a member of their young benefactors' group. I'd love to see the Torpedo Factory offer these types of artistic themed events (cocktails related to art, galas, beer/wine tastings, kid friendly programming). I'd also love more information about the artists and more focus on local Alexandria artists and student artists, with art available to purchase. And a variety of price points and type of mediums.
Integrate more events to bring folks into the center. We've been for Art on the Rocks, and it was a great way to see art and have a good time. The Torpedo Factory is a neat, unique space that can be quite boring for tourists and even for locals. Add a wine bar, or outdoor seating that integrates art, etc.
Vital part of why I live here and think it is so important to continue
Keep supporting the arts!
Add a venue to book events such as weddings or fundraisers if not already in existence.
Find ways for artist's work to be seen and used in the community. For example, how can TF engage the nonprofit community maybe through Act for Alexandria so Artists have the opportunity to be commissioned to make gifts for nonprofit annual gala guests. This offers something unique at for gala guests, gets TF and artist name out there and creates a three way bond between TF, Alexandria nonprofit and nice audience segment in Alexandria/DC. Feel free to contact me if you want to brainstorm the idea further. Derry Deringer, derry@deringerconsulting.com
Keep the Torpedo Factory open!
Include religious art and artists from various faith backgrounds. A Higher Power and interaction with humankind has always proven to be a fascinating and illuminating subject.
A great space to have farmers market on the weekends, and more activities or space for kids to use.
While we love the TF and are long time Alexandria residents, we rarely buy anything or do more than walk through on our way to the river/park/shops. It always seems like the same art, not very diverse, very expensive, and often - sadly quite tacky or stodgy/like hotel art or corporate art for DC office space. Would love to see a more international/diverse and more inclusive feel; cultural fairs celebrating different heritages, programs for families, places to gather/eat, etc. The tunnel you walk through still has many shops that feel outdated (shop with cat pajamas & tourist stuff) - would be great to see more fun shops/cafes in there with more lighting & less dreary. The improvements on the outside of the riverfront are lovely and would be nice for TF to upgrade. Such an important art and historical space we treasure - but would love to see it refreshed with the times. THANKS!
I love art and enjoy the art aspect of the Torpedo factory, along with the story the building tells. I think that story needs to be told better/ more. However, with the financial issues ongoing with the City, I don't think the city government needs to be utilizing tax dollars outside of grants, etc. to maintain or run the facility. Event space, artists and other private funds should cover maintenance and cost.
I wish that the outside of the Torpedo Factory fit in more with the area - even though there's that alley-type walk through area from Union to the Marina, it would be nice if the Factory had sort of blurry indoor/outdoor distinction - like big garage doors that can open up in the summer, or outdoor ground-level terraces.
Better bathrooms Access to rooftop

<p>It was boring, same, no artists, same art. Wasted potential. Need change, fresh events and art, activity, movement walking through an abandoned building. Changing art and artists--how about cultural events where bringing in lots of artists from a culture/region/something for a short exhibition to bring more people in and reach out to different folks from "old" people that currently go there. Does not think the city should provide this support not the way it is. Artists get low rent, COMMUNITY GETS NOTHING. No outreach to community from artists. Where's the diversity? Artists should be ambassadors. City gives them "free" space and they give nothing back. No kids programs for the community, no bringing art out into the community, no activity for tourists, like you have to ask permission to see their art in a public building. No diversity and ways to celebrate/highlight that diversity. its not a percentage to get its festivals, events. Right now, full of old people.</p>
<p>Get out of the landlord business.</p>
<p>Develop arts program for seniors, visit senior facilities as out reach. The artistic energy of the TF should not be confined within its ugly walls. Expand education programs and outreach to the community. TF is too exclusive or has that appearance that you must make the extra effort for art to come to you rather than art be part of your everyday life. Open studio space to quality artists-residency should not be a factor. Constantly closed studios should be kicked out. Create programs for demonstrations for public, especially children (i.e. puppet making). Create and develop art program/exhibits that focus on Alexandria/Potomac waterfront heritage. Visitors and even residence would appreciate experiencing regional/local art scene, modern or historical. Develop a fun competition that blends artistry and engineering and racing i.e. Baltimore's visual Arts museum. Consider integration with visual and performing arts in the public space. Develop programs for emerging street art i.e. Baltimore's visual Arts museum.</p>
<p>DO NOT TURN IT INTO A RESIDENTIAL COMMERCIAL BUILDING</p>
<p>no</p>
<p>parking</p>
<p>invite outsiders and advertise</p>
<p>NO!</p>
<p>great facility</p>
<p>none. more people should know about the stuff thats going on.</p>
<p>no leave it the way it is</p>
<p>I think subsidizing the studio space is an important part of the formula to make the TF work. Making living as an artist (or even as supplemental income) is difficult when you also have to pay high rental fees for space. I love that people can work there in that great, historic space.</p>
<p>I love the Art League component of the Torpedo Factory. I love going to the Torpedo Factory too but sometimes the art is out of my budgets. I would like if there were more places to eat and more opportunities for kids hand on activities. Thank you</p>
<p>Make it into something that would draw more people with different interests. Or an indoor market type place like Fanueil Hall in Boston or the indoor market in Milwaukee (don't know the name). Incorporate the outdoors if possible with cafe seating, outdoor stalls for vendors to sell their things, etc.</p>
<p>Nothing specific but please give enough notice for hearings, if any, and consider all proposals. Thanks.</p>
<p>I feel that the space is being underused and that there are great potential to better include city residents in visiting the Torpedo factory.</p>
<p>Maintaining a unique event space that is not just another corporate or generic attraction is important for the city.</p>
<p>Needs to rebrand as a public use space and less dedicated solely to art. If it is going to stay dedicated to</p>

artists, they should be required to have their space open minimum hours so it is worthwhile to go. Artists spaces are usually closed whenever I've been there.
Make it a destination for families and tourists. Discounted studio space could be offered someplace not as centrally located to tourists.
Parks shouldn't bother planning at all if they're not going to put the community's feedback to work. I'm tired of attending Parks meetings and being ignored. No one in upper management at Parks understands aquatics, planning, fitness, teamwork let alone any of the cultural institutions. Luckily the Library is somewhat separated as is the Museum. However, both of those get short shrift on funding. Arts and Parks should split. There's a huge contrast to Elections. They get almost no money but they do the best with what they've got, even on very short notice.
Given that it is city owned, it should provide more benefit to city residents. As it stands now, it appears to benefit the artists more than the residents as the artists get a cheap space to sell art. Residents should have a cheap place to make art. There are a plethora of for profit paint and sip / paint pottery businesses around. The City could also provide that to city residents at a discounted rate at Torpedo rather than just sell private artwork there.
Gift shop should be promoted better. T shirt prices children can afford to promote TFAC in and around the city. Gift shop and studios should be open for special events at the center.
Keep ok rockin
no
SHOULD NEVER REDUCED FUNDING
they should keep the torpedo factory and not sell it to developers.
KEEP IT IT'S THE CROWN JEWEL OF ALEXANDRIA
She thinks that the city needs to fund art programs to enhance people lives, to help bring more people should have live music there and people could listen to music and view art
no
I DON'T THINK SO
make nice condos
IT'S JUST A LOT OF SPACE HONESTLY WITH EXPENSIVE ART
rather it not become condos and go away
NO thank for keeping it open
I would expand it very carefully, and more evening and weekend classes.
branchout to diverse groups of people in city not just white women
no
JUST KEEP IT GOING
its odd it tends to be last thing i think to walk thru usually due to weather artist personality and lack of seating
MORE PARKING, MORE HISTORICAL SHOWINGS AND EVENTS
MORE INTEGRATION AND MORE WATER FRONT AMENITIES.
It should be supported and maintained. It's a good resource for the city residents. Its location is ideal. You can have a lot of tourists down there. And the residents enjoy walking along the downtown and Potomac river area.
remember that its important to visitors
Connect to the walking and biking paths downtown. See it as part of a network with the downtown and not as a stand-alone facility, and build more signage to remind people of that. Include the Torpedo Factory as a starting point.

IF THEY HAD MORE SPACE AND MORE HISTORY CONCERNING THE TORPEDO FACTORY.
more special events, make sure that the shops have increased opening hours, fix the bathrooms
I would like them to develop the Waterfront but it has to have an acknowledgement of the local history and community. I don't want it to be too commercialized. And another thing: do an installation on Civil War history and statues. It's about the interplay about the civil War and the current statues, the memorialization. I've driven enough down Jefferson Davis highway. It's a very hot topic.
no
no thanks
it really important for alexandria's identity and to provide a place for classes
no.
let the taxpayer keep it money
TRY TO MONITOR THEIR FISCAL SITUATION THERE HAS BEEN A BREHAHA BETWEEN THE ALEXADRIA AND THE ALEXADRIA YACHT CLUB THERE HAS BEEN A LOT OF POLITICAL FIGHTING.
maybe put some kind of website so people can see what is available and buy stuff. have more exposure via the website.
no advice
no i think they are going a very good job. in supporting the artist community through the torpedo factory and providing an attraction for visitors to old town
Advertising/social media
Great location and nice space, maybe we should use it for more things to bring more people to visit the location.
Dining options within the facility; covered outdoor area that overlooks the water (somewhere that you can sit or stand and look out at the water without being rained on or standing in the scorching sun).
The more family-friendly the studio is, the more interest I would have....great for birthday parties, family day, etc. With three small children, family time is critical to me.
It is a crap shoot when you go to the Torpedo Factory never know who will be there.
Taxes are already too high. Don't add on.
Incorporate themes in the City's Strategic Plan as part of telling the City's story past, present and perhaps vision of its future Envision it as an international center for artist from all over the world to come and display their art - like a peace filled United Nations where the medium of art is viewed/appreciated as a bridge builder and artists as ambassadors of kindness and compassion.
KEEP IT
Would love for it to feel livelier and more modern. Drinking and dining options would be a huge draw.
To bring in other local artist and musician
No
Survey is too long. More diversity needed in artists and shows.
More interdepartmental collaboration.
Have specific programs for kids all the time
More weekend kids activities, particularly for toddlers and preschool
More kids activities during the weekend day. Two working parents don't have many kids activities in the weekend.
better food and dog treats
Ways to get the business community involved.
Make wide open spaces on Waterfront-the plan sold out space. Try to attract cheap food trucks? and sports/children's team games there on weekends.

stop looking at this as merely a cash cow to fill city coppers. It is a terrific asset to our community. We are not sterile like many other boring suburbs. This is a vital dynamic place. I'd ask the politicians and developers to stop trying to ruin it with overpriced, ugly, cramped, commercial and residential developments. They have made parking a nightmare. Please stop it.
KEEP IT DONT GET RID OF IT
no
EVERYTHING THAT THEY ARE DOING IS FINE.
no
Parking is the nightmare/ Have a drop off place for uber and lyft
REALLY WORK ON BUILDING SOMETHING TO KEEP THE WATER OUT DURING FLOOD SEASON
I think they should continue to support it. It provides a vital addition to the community that is an added benefit to civic life. I think it's important.
Reach out to residents of city to bring them in. Marketing campaign
no.
Maybe if they did offer some class or some little project. I'm at the library and they have different craft days. If there was something for just \$20 or something. Or a game night, something that brings people in. A simple craft or demonstrations for crafts would be fun. Just to see someone doing their work.
try to reach out to civic and youth organizations non profit.
no
NO.
i cant think of anything
art and science that should not be taken away from community
make it more attractive and more inviting and tell the history. more to welcome people
no
KEEP IN MIND THE POSITIVITY OF THE COMMUNITY, AND LET THE PEOPLE EXPRESS FREELY THEIR THOUGHTS OR EMOTIONS. USE THE FACTORY AS A NETWORKING TOOL.
NONE
NO JUST AN APPRECIATION FOR LOCAL ARTIST
no
no
continue to have it
To put out more advertisement out there
no
encourage the city to keep it as a landmark
NO.
NO
consider different or additional uses for the space
no
TELL THE CITY TO NOT FORGET THE HISTORICAL NATURE OF THE CITY. ITS SO IMPORTANT TO THE SPACE, CITY AND THAT PART OF VIRGINIA .
CONTINUE WITH WHAT THEY ARE DOING PROMOTE MORE FOR SCHOOLS VISITING SCHOOLS AND MORE FOR KIDS
They do a very poor job on the economic planning for things. I don't have any advice other than don't do what you normally do. Don't screw it up.

no.
no
NEEDS TO KEPT THE WAY IT IS AND ITS A IMPORTANT PLACE TO KEEP CITY FUNDED
NO
I THINK THE IN TOWN ARTIST IS A GREAT IDEA BUT IF YOU NEED TO SHOWCASE OUT OF TOWN TO CREATE MORE OUT OF TOWN VISITORS THAT IS FINE A NEWSLETTER WOULD BE GREAT ADVERTISING USING THE SPACE AS AN EVENT SPACE BY HOSTING WEDDINGS CORPORATE EVENTS BEING ON THE WATERFRONT WOULD ATTRACT MANY VISITORS
no
NO COMMENT
no
SUPPORT IT IN EVERY WAY AND DO NOT LET A DEVELOPER TAKE OVER THAT PROPERTY
Just don't build luxury condos there. If you do change it should be affordable housing.
no
NOT AT THIS TIME.
no
that it be respectful of different economic groups of the city
put the parking meters back - i don't like the kiosks
NO
MORE PARKING, LESS EXPENSIVE PARKING,
stop putting so much money it s arts are nice let people pay for them ...
no
NO ADVICE
KEEP IT GOING, DON'T GET RID OF IT.
NO I THINK ITS A GREAT IDEA
NOT REALLY I FEEL LIKE IT AN INTERESTING PLACE THEY NEED TO SOMETHING ABOUT THE PAINT. IT MAKES IT LOOKS DUMPY. A LITTLE MORE MONEY IN MAINT.
NO
saw torpedo factory grow and its a wonderful thing to continue to support.
parking makes me crazy. do something about it.
i have none
RENOVATE THE OFFICE SPACE ADJACENT TO THE FACTORY
SELL IT AND REDUCE OUR TAXES
keep it going dont close it we still like to keep it going
DON'T STOP DOING WHAT YOU'RE DOING, I THINK IT'S IMPORTANT TO THE COMMUNITY, WE SHOULD CHAMPION THE ARTS AND IT SHOULDN'T BE DONE AWAY WITH
no
i dont believe it should be developed furtjher
i am an artist. i feel strongly about the arts being accessible. they have a beautiful facility on a beautiful site. maybe there should be more publicity
no
JUST KEEP IT THATS ALL
they should have a celebratory day for the torpedo factory
no. i dont have any ideas

no
THEY SHOULD KEEP A RELATIONSHIP FOR THE MUESUEM
i would see how you can make it with more interactivity with artists or special things happening. free classes by the water for watercolor or sketching for adults and for kids. have people person artist
could have something else in the space =maybe food = it's a large space don't know what else it could be used for
performances in open areas
not really
NOTHING THAT I CAN THINK OF
NO
replan it
no
nothing ath his time
nothing
opening themselves up to more people
would like to encourage the city to keep it like it is and dont let the devolepors take it over
keep going
MAINTAIN THE BUILDING. KEEP IT CLEAN.
NONE
keep it open for those people who have artistic expression
no
support the local artist
encourage it to grow
nothing
no
it could be used for other activities. broaden horizons
think its an instituion so i hope i would continue
no not necessarily
dont close it. it is a great feature to the city
no
Just to consider that the Waterfront is because of what's going on on the other side of it with the casino and high-level development, it's important to remember the cultural and more modest arts and individuals that Alexandria should be profiling. It's important that we think about people in the arts rather than making money.
if support artist some place ill go check enjoy parks go to and glad city supports them
Great place. Historic.
The artists don't have to be city residents but not sure about subsidizing rent for non-resident artists. During last visit gift shop was closed Did not like exhibit with Sheldon Scott and the Target Gallery
Maintain high standard for artists and art, artist need to exercise control over life of the center.
Enjoy it
Make the property self-sustaining with minimum city funding.
It draws me to Old Town more than anything other than the bike path and park areas.
Would 100% support establishing a childrens museum like space with a special focus on creating art and working with different mediums (perhaps with dedicated classes during week and drop in

opportunities on weekend) As such a large, indoor City space near parks and river, it really needs some dedicated children activities to better serve the larger community.
Please keep the Torpedo Factory as a space for artists sharing their work with the public. Would love to attend more events and open house type art shows and sales.
Education about art (history, diversity or the making of it) would be nice when visiting. Walking around is good, better when artists are present, but something interactive to learn more would be good. I think it will help newbies learn to appreciate the art work itself and the artists. I would also love to go to more events there (wine, entertainment, benefits, etc)
Would like to learn/participate in art.
Would visit an art center If they had more time
Interested in art. Would like to take art classes.
Likes art but does not participate in any art programs currently.
Would visit an art center to learn but does not participate in any programs currently.
Liked the Torpedo Factory but it was a quick visit. Would like to see the center and bring children. Does not currently participate in arts programs.
Would like to know and enjoy place of art. Would like to know about programs for paintings and activities with kids.
History/Art via history would make them visit an art center. Interested in sculpture and historic arts programs.
Interested in paintings.
Would visit to view and learn about art. Kids like to painting so would come to see.
Interested in architecture.
Would visit if they got information on art exhibits, events, family/kid events. Interested in sculpture.
Would like to visit an art center. Does not currently participate in any arts programs.
Does not participate in any arts programs but would like to visit an art center.
Would visit for family outings to see galleries, paintings and similar art.
I participate in arts programs at Casa Chirilagua. I'm a musician and play at my church and in my personal time with friends.
Not clear about the concept. Does not participate in arts programs.
Would visit if the art center had programs for kids. Children participate in art programs through Casa Chirilagua via Upcycle.
keep it open
no i dont have anything else
not sure s advertising person dont recall seeing advertising
keep it their continue letting artists rent the space out. no corpration. nothing gimmicky
no i cant say i have anything at the moment
Do not get rid of the Torpedo Favtory. It is one of the unique features of Old Town. Do not commercialize the waterfront.
Just like the failed/failing Lorton artists set up, I think this space would be better used with restaurants and other retail. I am pro-artists and support their work, but think that in a location like this so much more can be done with it.
More free workshops and kid-driven events please
Interactive kids space like Upcycle at Durant center or single day art classes would be a huge draw. I would probably go on a weekly basis. Having coffee shop is a great addition.
Advertise more. Better outreach for arts events in many languages.

Don't tear down. Fund it more to keep bldg current/updated. Advertise more. Birthday, special occasion packages to celebrate family and friends.
Used to work at the Torpedo Factory when it manufactured torpedo. He did not know that it was converted into an art center and was afraid that it was going to be a Torpedo Factory again. Lived in Alexandria all of his life. He thinks that there needs to be better advertising and outreach.
no
THEY NEED TO KEEP IT OPEN. I THINK IF THEY HAVE FUNCTIONS THEY SHOULD ANNOUNCE IT MORE. I WOULDN'T HAVE KNOWN ANYTHING ABOUT THE CENTER IF I HADN'T GONE WITH THE KIDS OR LIVED IN THE AREA.
REALLY CANT ADVETISE IT ENOUGH AND HAVING IT DOWN TOWN I CANT SAY ENOUGH GOOD THINGS
more parking too strict driving visitors away
NO
KEEP IT THERE AND PROVIDE FOR THE PUBLIC AND RESIDENTS FOR THE CITY
no
need public swimming for kids
NO
KEEP IT AT THE WATER FRONT.
NO I ENJOY THE FAICILITY
keep it open
HAVE DEVERSE EVENTS
NOTHING
NO I HAVENT THOUGHT ABOUT IT
NO
NO
I like the people outside who attract you in
try to improve more what they have. i havent gone in the last few years.
JUST KEEP IT
JUST VERY VALUABLE AND ITS IN A PRIME LOCATION AND WE SHOULDNT LOSE THE FLAVOR FROM THE WATER VIEW
Please leave it.
I would consider maybe doing more events there. And I would consider parking as an issue. I wouldn't want to take away space for parking, but maybe there's something else they can do.
Parking across the street although there needs to be better parking for handicapped individuals.
it would be nice if it was bigger
i would strongly suggest that they continue to support this even if this is a financial burden
improve the parking - offer discounts for Torpedo Factory visitors
no but i will raise that i have noticed a number of shops in old town that are not there anymore. so the torpedo can use its bully pulpit to help other artists and galleries.
Supporting the arts is very important to me and I am always delighted when Alexandria extends its support in any form. I am pregnant with my first child and hope the Torpedo Factory is around for him or her.
more outreach in different languages. more diverse arts programs needed celebrating different cultures.
Interesting marketing. Good logo needed. put in places where people will notice. need to generate more word of mouth about the art programs.

More funding to keep bldg updated. Culturally diverse art opportunities.
Keep it updated and clean
More advertising about events throughout the city. Diverse programming in a variety of languages.
More advertising. Have not heard that much about the TFAC.
Keep it open supporting artists and art endeavor. Expand activities that take place at the TFAC social events/city and other. Affordable to rent reasonable price.
More advertisement of events
Advertise more. Ethiopian community. Ethiopians in restaurants and shops on Pickett st.
Continue support. Keep up maintenance.
Advertising in different languages to involve more people. Culturally diverse arts programs.
More cultural events celebrating cultures.
Shorter online survey. Advertise everywhere.
Donate funds to social services
Traffic patterns need to get better. better parking available.
Not enough knowledge of current offerings at TFAC
More advertising. more open studios. vodka festival might be fun to have.
More outreach
ADVTISING
coffee shop
no advice
Never been but parking is always an issue
Review what hasn't worked and make it better.
Not really
Try to put other organizations under one non-competing umbrella i.e. "Arts District" More live demos and "working" arts center school and kids events
Accessibility and customer service
Compete w/National Harbor, be more creative/less conservative.
Need to compete w/National Harbor, DC Wharf, etc. We need to invest in this area. Good worth while changes require city investment like a rooftop bar/restaurant and a renovation of the inside of the factory.
Enough of what makes old town unique and enjoyable has already been destroyed. Please don't turn our art center into more condos and restaurants. What we have there is truly unique.
Torpedo Factory is awesome!! It can be a little dirty and the bathrooms/facilities are outdated. I do wish there was more structured events and more things were open, as I'm frequently there after it closes on the weekends.
I love the Torpedo Factory. I take out-of-town guests there. My husband and I wanted to support a local artist when we bought our house in Alexandria and we sought out artwork specifically at the TF.
It's time to evolve and make the TF building a market that is open daily. See Reading Terminal Market in Philadelphia and Mercato Centrale in Florence, Italy for inspiration. This would draw so many more people into the building and into that area of the waterfront and King Street. We need to compete with The Wharf (which is WAY better than what Alexandria has planned for their 15+ year build out of our waterfront) and this would be a differentiator.
The best times there were evening events with open bars and activities.
Give the place a facelift; make it more interactive and welcoming, particularly for children
My husband and I love the arts. We often go to art museums and exhibitions in DC. We would love to

<p>frequent the Torpedo Factory more frequently, especially during the week nights when we're less likely to visit DC, but the Torpedo Factory seems to be catered more for the artists (who seem to be long-term residents of the studios in the Torpedo Factory) rather than the public. Most young professionals who could purchase art are working during typical weekday business hours; the art displayed does not change often; I am not aware of events open to the public during weeknight evening hours or weekends and I am signed up for Parks&Recs communications. I would like to see more events and energy at the Torpedo Factory. There are sewing, yarn, paint & sip (which I believe is now closed), DIY craft shops spread throughout Old Town. If shops like these were housed within this area, the Torpedo Factory could be a hub for creativity and inspiration for many more Alexandria City residents, not just the current studio renters. More evening events during the week like exhibits, new artist debuts, wine socials, craft shops, crafting events, demonstrations would draw more people and energy in. I look forward to changes. If nothing else, please rotate the art. If demand outpaces supply for studio space, perhaps limiting the subsidy/discount to a certain number of consecutive terms would facilitate giving different artists a chance.</p>
<p>Include parking area, even though it may decrease art area.</p>
<p>Do not blindly chase the dollar. Even though I'm not an art enthusiast nor a strong supporter of the facility in its current use, I do value a City and community that doesn't simply look to draw blood from every stone. I would STRONGLY want any use of the facility to be with the community (ie not developers) in mind.</p>
<p>I love it - I should go more - if you held events I knew about I might go - I live nearby</p>
<p>Please maintain this wonderful and unique part of Alexandria. I think the signage needs improvement to attract visitors from King Street and waterfront.</p>
<p>the outstanding thing about the Torpedo Factory is its art classes. The studios are fine, but they should really be merit based and perhaps an art competition to pass to gain a studio.</p>
<p>Get a BID. support the small business in town.</p>
<p>More kid events!</p>
<p>Signage outside on sidewalks with what is happening that day. Advertise family events in Parks & Rec booklet for greater visibility</p>
<p>It would be nice to have more child friendly activities like the one that just pasted in October where kids were able to make several different items.</p>
<p>Evening events and open houses create a lot of buzz for the facility, so they are a great idea. Please upgrade/modernize the bathrooms. Some are unbearable in the summer (hot, stuffy, out of date).</p>
<p>Make the process of getting a studio more open and be more open to encouraging young artists instead of being clannish. Encourage artwork and art projects of those who are mentally ill or disabled and recognize that it is art, not scorn it as you have. Permit sharing of space if artists cannot be there full time.</p>
<p>Tourism is important to our city so keep in mind how the Torpedo Factory can anchor the waterfront. Would be great to enhance food/drink options there. We like the Santa visit every Dec!</p>
<p>No</p>
<p>More free parking</p>
<p>Keep studios open . I did not know about the archiology museum</p>
<p>Better parking options</p>
<p>Don't mess it up. It has gone downhill since the City started managing - much less visitor friendly</p>
<p>Become a venue to promote as a tie-in all the arts Music, literary, poetry, fine art. Also, More collaborative programming is needed with businesses and other art/nonprofit groups. There are a ton of associations in Alexandria. Offer occasional free art event for families to encourage the appreciation</p>

of art with young people. Do more marketing overall to let schools, residents and tourists to know about this venue. The Torpedo Factory is a unique venue. Promote it! Make the most of the space with small concerts, poetry readings, all the arts. Definitely loved the art lectures and they seemed well-attended. Do More of that.
No
Make it a multi-use building with food/drinking and activities for customers. Having higher paying vendors who can create revenue for the city.
Love it. Great asset or the city. Historic building.
Please keep it! It's gem!
More information about what's going on there; more art that isn't absurdly expensive; open studios where you can interact more with the artists; more tactile experiences that allow people to touch and feel art, not just stare at it through a window.
Host more events other than just Art.
Keep it.
Important to the city but should not be in this location needs to move. Torpedo Factory is located in prime business spot and does not attract enough business. Turn the building into use for businesses that generate revenue for the city. The TFAC should be like DC's Union Market but not on our waterfront.
More support for valuable asset that transformed Old Town. I am a native and the power of the arts in real time create positive changes in our community. this asset is not only a lively place for art it is economic development. it brands Alexandria as an interesting exciting place to visit.
Keep it going. It is unique and a real part of Alexandria. Maybe have some book or art talks right on the first floor, center hall, with folding chairs, to draw in folks.
Alexandria has not taken advantage of the river for public access, use in recreation vs. commuter. The TF and Alex. seaport are great attractions and have built "Alex" as a brand. Please do not over commercialize there places. More public art; sculpture; temp exhibits; reason to explore waterfront from north to south (Jones Pt.)
Keep it the same - don't raise rents or turn over to developers.
More food options
Historical events about the city. Titans school reunion at the waterfront/TF
The waterfront in general is important and keeping it non-commercialized as much as possible is important. Which includes the TF, the pier with boat residents, the parks etc.
Keep it going.
Improvement of the Madison Street facility of the Art League!
Keep on keepin on
Keep it! Do not let it go away. Continue to support and preserve the historic building.
History, art, tourist stop. keep.
Term limits and diversity of artists
Change artists many have been there since the beginning so why go back? Survey is way too long. Who did this survey!
The addition of the cafe was NECESSARY but it's still not big enough. The tables are too crowded.
Old Town has an opportunity to become an artist hotspot which attracts experiences for residents and tourists. Classes/Workshops at the Art League form a strong and wholesome community within the City.
Public toilets that are easy to find and accessible please

Give space for emerging artists that have a great work to share.
Encourage more diverse uses. While providing for artists is incredibly important to culture. Is it important that they are located in such a prominent waterfront building?
keep it
NOT TO MAKE IT COMMERCIAL,KEEP IT UNIQUE
handicap friendly and anybody that wants to use the art room use the rooms
No.
NOT REALLY
It's an older building and that's part of the appeal, but it could be touched up some. The bathrooms could be better.
KEEP IT GOING DESPITE THE EXPENCE IT PRIDES RESOUARES FOR CHILDREN AND FOR A RELAXING ENVIROMENT FOR PEOPLE IN GENRAL
no
no i cant think of any. a coffee shop you can sit in and get food
makle it a livier arts place and not convert it into condos or something
no im sure there is ample discussion of it. i think the whole history of the water front needs to be emphasised
KEEP THE TORPEDO FACTORY THERE,INVEST MORE MONEY IT'S THE CONNER STONE OF OUR CITY
NO UNLESS THEY TURN IT INTO ANOTHER RESTURAUNT
I HAVE NO IDEA
WOULDNT CHANGE ANYTHING , IT ALL SEEMS TO DO VERY WELL.
Since I've no idea what they're planning, maybe involve us more? The city needs to put more money into it or find a way to deepen it in some way. Make it better. Maybe it's no money at all, maybe they link up to the Smithsonian. It feels very small town.
no keep it i like its very important
DON'T SELL OUT
no
INCORPORATE OTHER ART FORMS WHETHER ITS MUSIC OR THEATER ART
CUT EM LOOSE AND LET THEM OPERATE ON THEIR OWN. FOCUS ON THE THINGS THAT NEED TO FIXED WITHIN THE CITY. CUT THE SUBSIDY
NEEDS TO MORE UNIFIED. THE ARTISTS AND THE PPL ON THE BOARD.
The Torpedo Factory is awesome. It makes Alexandria a great place. Other than that my wallet got stolen. And there's no cameras in there anywhere, so I couldn't tell the police where to look.
no

ART LEAGUE SURVEY COMMENTS

Other - Write In: What do you think makes it important to Alexandria's identity?
I think it SHOULD be important to Alexandria's identity but isn't.
All of the above!!
is central as our reputation as an art city
I think it could be many of the things listed above - and used to be - but it is not.
fantastic for kids
All of the above.
Important gathering site
Architecture
decent programs for community
It is a destination to visit after a restaurant meal
Helps artists
the TF is involved with schools, and creating art in the community, and worked to open up artistic experiences to other artists who are from other places.
renovation of historical site of importance
provides space for art classes that many people take
potential for active arts
Archaeology!
It's important as a cultural center - children need to see adults working as artists in order to see themselves as artists. We need more artists in this world.
Place to buy art
it's unique
Fun and free destination for visitors of all ages
Provides space for art education
Reuse of old buildings
Place for artists to do their work in a community
Becoming one of the few unique experiences inn Old Town.
This place needs HELP....IT IS NOT VIBRANT OR INVITING....YOU SEE OLD PEOPLE SITTING AROUND ARTISTS DON'T INTERACT WITH VISITORS IT ISN'T AHAPPENING PLACE
Place to purchase original art from people you can meet and/or know.
It is one of the few centers of excellence in metro DC in art.
Great community programs too: SOHO, Veterans, etc.
nice reuse of old building
its an arts experience that is part of the waterfront experience
Combination of city history, art and providing unique service to residents and visitors

Other - Write In: When you visit the Torpedo Factory, why do you go there?
visit artist/friends there
I have become familiar with several artists and I like to visit them to see their new projects.
to talk to the artist about their work
Used to go there all the time to buy art, but increasingly found the studios closed, so stopped going (i.e. years ago I used to go at least once a month. But now really am only there if something else brings me to Old Town).
Classes
rest room usage, food purchase
First night
Art Safari
I go several times a month. It's a happy place for me.
For Arts Meetings, and to go and look at poetry and other arts items that are for sale I like to purchase them for myself and for others.
art class
visit artists I know
Art on Tap and similar events
I'm a member artist - I work there!
My kids like the archaeology exhibit
Because I am a member.
I can take my dog there!
to take classes and enter shows
I am a volunteer
Teach classes, make art
I pass through once a week on the way to my job at Vola's....the outside is filled with trash cigarette butts cans and waterbottles.....seems like no one cares!
I work there.
Using local resources, to connect globally.
classes
a special event produced by the Torpedo Factory e.g. the Late Night events, Art Safari
visit artists
ART LECTURES

Other - Write In: What do you like most about the Torpedo Factory?
Opportunity to purchase art which is handcrafted and unique.
Again, if this question applied to the TFAC 15 years ago, I could click a lot of the things above. But the TFAC today just seems tired and mostly closed off.
Restrooms convenient to Waterfront
great place for kids to meet artists and observe them working -- Torpedo Factory artists are very willing to engage with children
All of the above.
Caliber of the art is high even if it's not all my style
it's a destination, an anchor in Old Town
Archaeology!
As a working artist, having a place with so much inspiration adds to the creative energy of the place. The building needs some love and updates to be sure.
show opening receptions
Art League creates a caring, creative community for me
art exhibits at Art League
dog friendly
The Art League
Convenient to buy art supplies
It is just THERE! It could be SO much better.....the people there are just lulled into sameness
It's a chill place in a world burning up.
Part of the fabric of Alexandria.
critical mass of art within one cool unique space
I visited a particular artist, that doesn't list the Torpedo Factory in their address, just N. Union St.
ART LECTURES LEARNING ABOUT ARTISTS
Location is very important
Patrons Art Auction
It's a great special events space
Meeting and talking with artists

Other - Write In: Was there something specific that would have made your visit to the Torpedo Factory better? Or if it fell short of your expectations, how so?
It's deeply frustrating to me to see so much potential not acted on. The center should a beacon for the arts in Alexandria, reflecting the demographics of the city. It should be an economic drive for the area. I want it to be so much better than it is.
Nothing negative, love this place
Fine
Nothing fell short
It would be great to walk around the Torpedo Factory with a glass of wine
Few good places to eat or drink
it would I have seen the prices of art vary more lately than in the past and that is helpful -- it is nice to be able to participate in supporting the artists at a cost of less than \$100.
did not fall short
It was a nice experience.
I always enjoy my time at TF
Nothing
No complaints
I love this place and the friendly, working artists. As a mom with a toddler, a small kids space would be fun- but I wouldn't want to alter much of the place at all.
not a good map of the building inside that shows where things are
Artists do not keep their hours.
would like a greater variety of art, Would like glass art, weaving and dyeing demonstrations for wool, silk and cotton, Too much focus on painting, drawing, and prints , more engagement with the community and schools
I wish the building was pet-free, other than service animals.
I was sorry to see the artists frustrated by City Management policies, e.g. raising the rent and not maintaining the building adequately.
need better, cheaper parking options
The art supply shop has a very limited supply and did not have what I was looking for.
None of the above apply to my view of this unique center
The bathrooms are horrible! They need to be updated.
always good
easier/cheaper parking
Parking a problem
parking could be easier!
I am offended by the prominently placed anti-Trump signs in the upstairs window facing the harbor. This is an insult to 30 million voters and to the current President.
nothing wrong
Too Quiet and boring
Question should be: was there something you would like to see more of...
Nothing negative!
I'd like to see more of a variety of local artists - maybe a weekly or monthly show where locals (not just

the artists at the factory) can show work
Parking is an issue everywhere in OTX
Map for artists locations was inaccurate.
Some of the art looks very commercial. Selling reproductions seems very tacky.
lovely place, and lots of excellent restaurants close by.
I always enjoy visiting TF
It would be better if they had free pony rides and hydrofoil for pedestrians and bikers.
None of the above
I would like to see more variety in the artists creating work - maybe add more disciplines such as musical instrument making -
the center could be more visually inviting, more activated with events and demos, welcoming (say 'Welcome', smile etc.) and orient people better, re-organize space to draw people to space throughout the building, make it a cool, must visit place because of art and creativity that is engaging, compelling and fun, invite younger artists and more contemporary and immersive work
It doesn't have an identity. Its either studios for working, professional artists or a shopping craft mall. Who knows? I would prefer studios for serious artists on the upper levels and a fun interactive space on the main floor
It's fine
needs better lighting
Hard to park
I think there should be more control by the resident artists.
I love it. Its a reason why I live here
The bathrooms seem to always be dirty/broken. I love the atmosphere that the working studios create - but the facility itself seems poorly run and managed.
I only attend the TF for special events and do not visit to buy/experience art
Improve Parking
Souvenir t shirts should be locally made and designed by TF artists
I enjoy it's place in the community

Other - Write In: What would encourage you to visit the Torpedo Factory more often?
Like it as is.
To me, Torpedo factory is unique. I always shop for gifts as well as my personal collection of art
I think it would be great to have other types of art: performing arts, culinary arts etc., not just visual art.
more opportunities for emerging artists
Add the indoor farmer's market feel esp. as the winter comes this venue would be great
walk around the place with Wine
I like that it's NOT a child-dedicated space, but that there are plenty of options for engaging children in the Archaeology museum and with artists in their studios. I would prefer we not create children-specific space within the Torpedo Factory. (mother of three children)
When visiting with tourists it closes too early on weekends
I visit often.
More history/archaeology instead of art. The art is TERRIBLE.
We go frequently but understand the artists are frustrated by the City's Management.
more convenient parking
lectures, artist talks
easier cheaper parking
guest artist lectures/demos
popularity of restaurants in Old town-are you asking about restaurants IN the Torpedo Factory? why?
Cheaper art is NOT art.
parties like the Mardi Gras Party. Maybe a Halloween Costume Party for adults with live music, etc.
Have you counted how many bars and restaurants there already are? Seriously.
stop insulting visitors with political insults.
As stated - I think a weekly local artist market would do well to bring in more tourists and create more variety.
Higher-quality art
I enjoy everything about the Torpedo Factory
I go whenever I want, no problem.
Cultural/art exchanges with artists of other countries.
more 'happenings', make it a center where there is always cool creative stuff happening where audiences can be engaged, exciting big art projects, cool interior design that is lightfilled and fun environment
Notable artists in-residence
Artists to be open during lunchtime and other times when customers can actually purchase items.
Please keep this as an art center and not an area of cafes and non-artistic activities.
City stop picking on them, keep it true to its roots
Holiday specific kiosks, like tree ornaments
I visit regularly - it is an important part of our community

Other - Write In: What types of activities would make you visit the Waterfront more often?
The homeless scare the visitors
I walk there almost every day

Is there any other advice you would offer to the City as it plans for the Torpedo Factory's future?
It's deeply frustrating to me to see so much potential not acted on. The center should be a beacon for the arts in the region and certainly in Alexandria, reflecting the demographics of the city. It should be an economic driver for us, not a dusty, quiet, public restroom. Resident artists don't necessarily have to be from Alexandria, but some should. Right now artists have been there for decades. So many studios are constantly closed and so many artists have zero drive to innovate or push themselves. However, I want to stress that the potential for what the TFAC could be is exhilarating to me. I'd love to see an art center making space for regional exciting artists of all ages and backgrounds. I'd love to see innovation, collaboration and risk-taking in the arts taking place there. I'd love to see, and feel, an air of inclusion. I'd love to see artists there regularly garnering press and excitement from regional periodicals. I'd love to see TFAC be a destination for tourists and regular to-do for locals because the programming is diverse, relevant and changes. I'd love to see the TFAC be a backdrop space for people to hang out in for a coffee/wine to meet with friends.
Activate the space. Minimize the space devoted to art studios (particularly since they're frequently closed or nobody is working). Add more opportunities for eating, drinking, dancing at the Torpedo Factory. Stop subsidizing non-resident artists. Provide fun, interactive things for kids to do. Add evening hours. Offer something people can't find elsewhere... make it feel as fresh and innovative as it did 40 years ago.
Keep the beer out, this does not have to be party central or a major shopping mall.
No
Some of the questions make it difficult to give a good answer. I like the fact that there are Alexandria artists, but it should not be exclusive to Alexandria artists. I also think there should be some rotation of artists/art - especially for those who aren't that successful at using their space/displaying art/engaging the public. Perhaps have some metric for determining an artist's success/activity and reward those who work more/sell more with continued leases - but MUST get rid of dead weight. There are artists that have been in the Torpedo Factory since I was in grade school back in the 70's who are just taking up space and should be replaced. Also, the first floor should have something else - retail/restaurants/event space to make it more engaging to the public day and night.
The TF and Art League are wonderful!! The TF was a primary, major impetus to the revitalization of Old Town in the 70's. It is a unique and rich City resource and should be eagerly assisted, supported and protected by the Mayor and Members of City Council
I don't feel that a corporation should be overseeing this site and totally managing this venue. It in itself is so unique and worth preserving. Too many touristy shops with cheap souvenirs which to me is so unattractive and distracts from the charm and history of Old Town.
It's a gem and unique experience! Conduct tours, do more events but keep it!
Free parking. Is go so much more
The TF is unique to Alexandria's cultural ecosystem. There are few other places where you can view and interact with artists at work. It is important for people to connect with art that isn't mass-produced. I treasure the art I've purchased at the TF because I feel a connection having met the artists.
Don't make it another mixed use project ie retail, residence, restaurants. Alexandria has too many of these buildings.

<p>It would be interesting to understand how artist are juried into the Factory. Would it be possible to have qualified local residents on the jury? Would it be possible to have a torpedo factory only art festival on the waterfront like the fall arts festival on King Street.</p>
<p>Some artists are more engaging and welcoming than others. More (public) activity in the evening would be nice. Restrooms are worn, cramped, and often dirty - a bad impression for visitors.</p>
<p>Find a way to make it unique again. If I want to watch someone paint, I can do that on YouTube. Broaden the view of "art". Do things that can generate income for the city to support the subsidizing -- i.e., facility rentals/events/food venue (what if we had a culinary arts program with a cafe -- could be a training ground for our local restaurants and also be a source of income for the city). Can the rooftop be used for outdoor space with great views? Give residents and visitors alike a reason to go there. Just having occasionally open art studios does not draw people in. Most people just go in to use the bathroom.</p>
<p>artists should only be temporary. that's why emerging artists need to be given an opportunity to create in such an awesome environment as well. sorry, but if they (artists) want long-term, permanent collaborative studio and gallery location, that is not the City's responsibility. and has anyone ever been to other nearby Art Leagues and checked out the events they hold? i've been to Rehoboth, Ocean City, Rockville, Northern Neck. these are places we regularly go to when we visit these areas. yet for some reason i have no interest in visiting the ALX location. there's just something not appealing about it.</p>
<p>Please don't mess with a place that works very well and is truly special. The best artists in the area need collaborative space and that is what it is about. Please do not add a requirement that artists or teachers be city residents. Everyone who is talented should be encouraged regardless of where they live and their work enjoyed. Also do not add restaurants or more food space to the first floor. There are plenty of other places nearby to eat. Display areas other than the League gallery are not needed - the studios provide that. Just please continue to support the Torpedo Factory by maintaining the building, renovating plumbing and electrical when needed, and fixing up the classrooms. Having it in my city is one of the best things about living here.</p>
<p>Increase publications, local signs, and web presence/marketing to increase awareness and information available about the Torpedo Factory Art Center.</p>
<p>Please keep the Torpedo Factory. A big asset for Alexandria</p>
<p>Make it more hip. Bring in younger, more adventurous artists!</p>
<p>Very worthwhile to consider how to make the Torpedo Factory a more engaging place for residents and tourists to visit. It has a great potential (fantastic history and creative/art focus) but needs a refresh of approach.</p>
<p>The City does not really have the money for this kind of facility that cannot even sustain itself prior to the City takeover. Other funding priorities should take precedence over publicly subsidizing the Torpedo Factory. The city already subsidizes the Durant arts center and the Del Ray Artisans with no appreciable return on public investment. The city should return these facilities to private management and let the market determine the appropriate outcome. The city should seriously consider selling the Torpedo Factory to a private developer.</p>
<p>I'd definitely suggest trying to find ways to make it more engaging and encourage more people to visit regularly. I was surprised the questions here about frequency had even the most frequent visits "multiple times a year" and "a few times in the last six months". I live in the del ray area and I visit the torpedo factory multiple times a month, and it would be cool to see more things going on there. Like the Edgar Allen Poe event that was held a while ago, that was very interesting and fun, and it let people see a different side of what the factory is.</p>
<p>strong leadership can ensure the venue provides low cost leases to artist while providing a destination for tourist. I do believe the space is under-utilized and has great potential.</p>
<p>Consider mixed usage of the space for non-franchise food court, event/ activity/ demonstrations,</p>

<p>weekday classroom use (for Alexandria schools) and evening/weekend use for adult education/ meeting rentals, and long-term leases to educational nonprofits with STEAM programming for exhibition, display, and activities.</p>
<p>While subsidizing artist is important, the subsidy is too much. The city should try to get artist who are more serious about making a living with their art so they can be more self supporting.</p>
<p>The Torpedo Factory is great precisely because it is not a cookie-cutter experience. Yes, please push to learn what changes will improve both the public and the artists' experience, but by no means should we overhaul the concept. The money we spend is WELL worth it and I'm sure comes back to us in the form of a richer community not to mention financially from individuals who create profitable careers as artists and as hosts to many visitors to our city.</p>
<p>Please maintain the unique character of the Torpedo Factory. Don't turn it into a shopping/restaurant/bar type place. Old Town has enough of that.</p>
<p>I have lived in Alexandria since 1984. Prior to relocating here, I heard about the Torpedo Factory. It has been a model for other Art Centers since it was conceived. It adds to Alexandria's uniqueness. The Torpedo Factory provides people opportunities to explore art, discuss art and to learn about art in an interesting atmosphere, versus a dry, "don't touch" museum. I think it is a plus to see a person actually producing art and having the chance to interact with the artist.</p>
<p>Please keep the Torpedo Factory as space for art and artists, and ensure affordability for artists to create art in the studios. Do not expect artists themselves to make \$\$ individually for the city--it is the the entire building and its artists together that make it a destination for locals and tourists. They bring in money for the city by their visits.</p>
<p>Please don't let this City treasure change and loose it's essence. Always a concern with building up the water front and unrealistic expectations from the city leaders and citizens.</p>
<p>No</p>
<p>Keep it and even expand its reach.</p>
<p>We love the TF and bring family and friends whenever we can. The TF is unique and brings artists and art lovers together in approachable and tangible ways. Thank you for continuing the support of this great facility and community</p>
<p>Keep this unique place with its wonderful opportunities for education, art appreciation and purchasing of affordable but unique art. My daughter took lessons there as have I. It has benefitted all ages. A local treasure.</p>
<p>Keep the history intact</p>
<p>Please do not sell the torpedo factory to developers to turn it into housing or more restaurants. We have several other retail and housing developments currently in the city and we need more space for the community to enjoy, not less.</p>
<p>Don't screw it up.</p>
<p>Highlight the archaeology, past and ongoing. Create small "how I work" exhibits from artists. Do not lose the friendly art-based experience to cafes, and such. Consider some 2-hour parking remuneration for visitors to TF.</p>
<p>Keep it as is. Wonderful place.</p>
<p>Display more Torpedo Factory art throughout the city. Maybe on the buses, too. Offer more affordable prices on classes, maybe offer a free "tester" class. Free art projects to get more folks involved.</p>
<p>The TF is a very successful venue as is. Think very carefully about making any changes.</p>
<p>Remember the ages 10-16 population. They are under served by city programs. Children's programs end at age 10 or 12 and adult programs don't start until age 16 or older.</p>
<p>Keep it and expand it - more studio spaces</p>

Just keep it there
My favorite thing about the Torpedo Factory is the diversity of art. The more unique art, the better the experience.
There needs to be cheaper parking options. I like it when there are musicians in the area around the building. I love it when the guy plays with water glasses near the shuttle bus stop. There should be street performers on the wharf and in the alleys & streets around the building maybe the deadend area at the bottom of King Street. Inside the building there is only one coffee shop and it is very expensive.
Don't remove the torpedo factory, it's a very important place for the city and the artist community.
Please don't change its essential character as it is. I love visiting and seeing working artists and such a variety of art.
1. I don't think city staff should directly be managing the factory--this is an overreach and not an efficient use of limited city resources. 2. I want the city to make a real investment in the art center to help make the waterfront competitive with National Harbor and the Wharf. Money is tight. I know. This is a NECESSARY investment to make the area thrive.
Create a maker space where folks can drop in and create things using different media- metal (small welding project), 3D pens (Doodle art) make paper, fingerpaint, make colorful or magnetic slime, adult/community coloring Station. Do like the large chalkboard you have near the entrance and like the unique displays eggs. The decorated doors and the Friday Kahlo display.
The Torpedo Factory and the Art League are part of Old Town's identity and should be preserved and nurtured
don't ruin the idea and atmosphere by putting in multiple eateries
The world needs Art! Without art the world would be in constant chaos. Kids need to be exposed to art - a person who has art in their life is seldom bored or thinking of war. Most large cities have places for artists to exhibit - it gives the city prestige and respect.
Love the torpedo factory!
As I have said before I would like to have more engagement between TF and schools and other outside groups, would like a performance space, greater diversity in kinds of art would especially like to see dyeing and weaving demonstrations, (one of my favorite Textile Museum events was when they did sheep shearing and fabric and yarn dyeing in their garden grounds. This was done frequently. This could be done on the Waterfront. Kids really loved this and so did the parents) Would also like more glass art, and metal art and more joint celebrations celebrating the diversity of the population in Alexandria and the region. How about some art and artists from El Salvador, Guatemala, Nicaragua, Ethiopia, Mongolia, Vietnam or Korea, We have large populations of these groups in Alexandria and Northern VA . We need to engage local residents and bring other populations across our region to Alexandria. Not all of the artists have to be from Alexandria, More joint artistic endeavors, art work for sale should be at a variety of price points. Open in evenings. More and better food choices. Lavatories more accessible. Have a joint effort with the Archaeology Museum and artists to see how items in their collection could be used to inspire new art works for homes and businesses. Could some of the items inspire the creation of door handles, hooks, light fixtures, bar fixtures, benches, shelves, bookends, etc? These could then be purchased. Some might even be able to go into some sort of limited production and be available for sale. Have artists create designs for tote bags, bow ties and long ties, scarves, socks, and other small wearable items which could celebrate Alexandria's history and diversity. These could then be available for sale in both TF and other local shops with the money raised being used to support artistic events at TF and the Waterfront. These could also be sold on line. My recent visits to TF in the last year have been fewer because I have been very ill
It is not successful as an arts space. Would be much better as a history museum slash waterfront visitors center.

Keep it open and where it is.
Get out of administration of the Torpedo Factory. Many artists are frustrated by the City's Management. The City could kill the goose that laid the golden egg. The Torpedo Factory is one of the very top attractions in Olde Towne! If artists keep leaving the facility then it will not be an attraction meeting tourists' expectations.
It is a unique experience and location that no other city nearby has. It would be sad to see its prominence diminished or turned into more generic space for tourists.
I love the Torpedo Factory. I've taken great classes, my sister met her husband in a class, I've been to shows and openings and sold my art there. It's a unique space and a real treasure for the city.
I wish the city offered students opportunities to be mentored by working artists. I don't think we help students know there are careers in the arts. The Torpedo Factory seems like a good venue for this
Torpedo Factory as an artist's center is an important asset to the city. It should remain intact and continue to be a major reason for people to visit old town.
Make it more active and with all arts, music, performing, dance. Much wider variety and diverse art.
Don't cheapen it, keep the arts local, keep the arts made by artists, give parking vouchers if people shop in the Torpedo Factory
This could be a great space think... something like union market
This is a historical building that is appreciated as that. Allowing the structure to become a working artists center has become a gift to residents and visitors alike. The only advice I might offer would be to advertise more broadly the value of this center and its wonderful location. I live in two locations, in Alexandria and in Williamsburg and am surprised that more folks in WB aren't familiar with the TP and its unique contribution to the community and to anyone who has an interest in art and the value of an art to those who wish to take the time to appreciate.
The torpedo factory has been a staple of my childhood for as long as I can remember. It gave me and many others I know who also went into art as a career inspiration and opportunities to grow and flourish as artists
I have been to the waterfront and around the factory, but wasn't interested enough to go in. It didn't seem very engaging, but more like a tourist place to spend money on stuff.
Please keep it. I assume that's what this survey is about.
N/a
Torpedo Factory is essential to Alexandria's cultural vitality for locals and for attracting tourists. However, the center falls very short of its potential.
Large, outdoor art pieces to entice people to come in. Big statues in the park next door or on the wharf. Paintings on the exterior (I know Marsha Steiger is displayed on buildings in Crystal City for example).
Limiting the artists of the Torpedo Factory to Alexandria residents will not increase the diversity of artists - Alexandria is not an inexpensive place to live and as such does not attract all socio-economic levels of individuals. Artists require cheap creative spaces within a more economically booming community like Alexandria to draw people with deeper pockets interested in buying artwork. If other POC artists and historically marginalized folks felt Alexandria welcomed them, more would see themselves in the space. The city has not done a good job marketing these opportunities to all people. Our blind jurying process is very good - we must continue to uphold a high standard of artwork within our walls. Do not lower the quality to satisfy consumers interested in cheap art. They can get that at Ikea or Target. This is about unique, original art-work and working artists. This should not be about undercutting working artists. It should be about supporting the arts and impressing upon people the cost of creating artwork. It's not cheap or easy -- it takes skill, talent, and sacrifice. The Torpedo Factory is not a yard sale! How about you invest in redoing the bathrooms?! The new cleaners do not keep them clean at all - toilet paper is often out. The place smells of bleach but isn't clean. nicer bathrooms would help attract more events like

weddings and corporate parties interested in the unique space. The vent systems need to also be cleaned - there is so much dust in our HVAC that I'm surprised more artists aren't ill. The city needs to invest in the infrastructure of the building but not at the expense of artists. Increasing rent will hurt the artists. You will not retain/keep the artists that are struggling - we will have to increase prices, not lower them to make up the difference. We need a capital campaign. Right now, I wouldn't know who to donate money to at the torpedo factory! is it tax deductible? why aren't we attracting corporate partners to help us with this? It seems like the city is forceably trying to push artists out in order to bring in higher paying, lesser quality, factory made crap for the waterfront. Don't kill Old Town's charm. Invest locally. Tourists don't want plastic, they want authentic.
Continue to offer Alexandria residents this special place. The torpedo factory is unique and an arts sanctuary.
Just don't take it away.
Discounted parking; make the discount available by receiving a stamp from an artist, signifying a purchase or at the artist's discretion, a "welcome"
Recognize the value of this wonderful resource. Treasure the creativity of our community. Do whatever you can to make it as accessible as possible without changing it from a creative opportunity to a commodity.
The Torpedo is a unique art institution. It's not the National Harbor and should not try to compete. It has given Alexandria a reputation as an Art and Cultural destination. If people want cheap art and trinkets they can visit the National Harbor
The most important value for me personally is related to arts education & sparking creative expression especially for emerging artists or to destigmatize art for classically trained artists only. Please do not lose sight of that with pressures to commercialize the space for tourism dollars
Offer more activities within the Torpedo Factory. Most of the times we go during week-days, there's nothing going on other than watching a few artists ta work.
no
Please keep the Torpedo Factory going and allow a place for artists to work and educate us about art.
Think of it as an important economic attraction that requires City investment, in rent subsidies to make them affordable by artists, and in maintenance of the physical plant. To see it just as an expense would be absurdly short-sighted.
I love having Torpedo Factory and living in Alexandria - it definitely is an asset to have in the city and I love taking classes there.
I love this place and think it's quite an asset to the city. I do wish the bathrooms were kept cleaner. They are often out of paper and frequently smell. I would also appreciate knowing what's going on at the factory more often. They seem to have a lot of events, but they generally are not listed in the local paper. This time last year they had a rather amazing theater production about Edgar Allen Poe. By the time I heard about it the event was completely sold out and I don't think they're doing it again this year. I read the paper, so don't know why these events are more widely advertised.
that building has the potential to be a HUGE catalyst for King Street and the waterfront. continuing to operate 'as is' will not catalyze- so deciding on status quo is a decision with a negative economic impact. adding food/beverage/nightlife will only help artists by bringing more people in, more often. significant renovations to the building should be made to open it up to the waterfront and to the street!
Keep communication channels open for both artists, and business types while deciding the Torpedo Factory's future. Please don't just make bureaucratic decisions.
The Torpedo Factory is a tremendous asset to the city, the community, and artists. Be careful in making changes, so as not to undermine its success.
If you want public money, then you should not allow political displays that insult a minority of city

residents. My tax dollars should not go to support anti-Trump window signs. This would not be tolerated if the signs expressed anti-Muslim, anti-Black, or anti-Illegal Immigrant views.
Please don't replace a unique resource with the same old boring choices of shops that are in every city in the country. It is one of a kind and should be cherished as such
Please keep it where it is! I have taken classes there so I know about the torpedo factory but I think communication & signage could be improved. If I didn't know about the space and walked by it on the street, I may not know that I could walk in!
KEEP IT! You will greatly reduce Alexandria's popularity and business opportunities if you close it or change the model too much. Artists need to feel like they have major decision-making power; otherwise, the whole nature of the TP changes and artists feel co-opted. Not good for anyone.
It's such a prominent location on waterfront. Needs to be more engaging -outreaching. Art-full but with a mix of studio artists and things to engage visitors in art. And not just 3-D art but music, dance, poetry. It should be a center if and for art. Even art-full food and drinks. The waterfront is so underutilized. There is nothing to do. The Torpedo Factory should be the cornerstone of 'stuff to do' fit all ages - especially since the City owns it!!!
The art and artists are great. But you need something else to make it lively and to get more traffic in there. It is too quiet and boring when you walk in.
Wider range of art courses.
Just hope they know how far and wide the Torpedo Factory is known and that it is something very important to a lot of people, especially artists. I go there to get my creative juices flowing.
The TFAA offered an alternative to the City's running the factory. The TFAA plan, which would save the city money and result in a more dynamic facility, should be accepted and implemented.
It works well. Small changes might be useful, but wholesale change would be ridiculous. Good mix of artists (focus on local but a mix); classes; events and advertising.
As the architecture and commerce in Alexandria become more generic, it's important to have an authentic art space that is unique to Old Town. Don't corporatize the Torpedo Factory.
Please don't change it. It is the heart of Old Town Alexandria.
Again - I think a weekly local artist market where local artists could sell their work would be great. I think it would bring in tourists and expand the reach of the factory. I suspect the prices would be lower than some of the more established artists at the TF. It would also be good for the local artist community, especially if you kept the cost of entry the market low. As a local part-time artist, I see few opportunities to really exhibit or sell my works at the factory.
The Art League School is extremely important as a means to creating and learning skills in making art. There are so few places available that offers the quality of instruction as the Art League School.
Keep it as an artist community.
Don't commercialize the Torpedo Factory with restaurants and bars. It's a unique art space that adds to the character of Old Town.
Cater more to art critics and less to tourists. Abolish the tacky King Street Festival of the Arts.
KEEP THE TORPEDO FACTORY!!! The Madison Street addition is fabulous!
Need to find more ways to engage and involve local residents and organizations.
Keep it's unique, creative atmosphere combining art and art school. No franchises.
Leave the torpedo factory alone!!!!!!!!!!
Keep it alive and well. That is why I moved to Alexandria!
It's wonderful reuse of old waterfront structure for creative citizen use , recreation & enjoyment of waterfront. Besides taking classes , visiting art studios love to stroll and eat along riverfront.
Currently it's like stepping into 1982 - tired and boring. The first floor needs an overhaul that would give

visitors to the waterfront (both tourists and locals) something to come back for. That's not happening now.
Support the artists who are there. Help them market their work. Keep the studio rent affordable for the artists. Working artists are the key to a successful and unique Torpedo Factory.
Less Burocratic BS for an art center run by artist and not county employees that have no artistic inclination or education. An art center should be an alternative place that is can be enjoyable for many diverse groups of people and not only kids, that is why you have a community center which is under utilized and the kid projects could be directed. Quality of the art and artist and exhibitions should be the main focus and the latest exhibits run by the city are clearly BELOW par and should be put in many of the other structures that the city owns.(Durant ,etc.) The Torpedo factory doesn't need to become a community center, the city already has one.
It needs more millennial friendly events. Things people would usually go to DC for.
As we say in the city....BRING IT UP TO CODE! It is dull boring and needs major help from creative people and FAST!
Keep it. Invest in it. Value it.
The factory is an essential part of Alexandria. The artists are gifted, but many of them have been in the same spaces for decades. Shuffling the studios and creating exciting, focused exhibits would generate excitement. The torpedo factory is essentially an active museum and needs to have more stimulating events for the public. Putting a restaurant or bar or multipurpose space on the top floor with a view of the river would be a wonderful draw instead of the rabbit warren of studios. Putting rotating exhibits up there would be an even greater attraction and highlight artists and artistic genres. And would be a terrific event space with some rental income!
Keep it going!!! We love it!
Support it. Help it expand its outreach to the city. The Torpedo Factory is a significant attraction in the city. It elevates the quality of life for residents. We have moved back to Alexandria after a 20 year absence. I have been significantly disappointed with our return. The Torpedo Factory is sustaining me.
The Torpedo Factory should be vibrant center of activities and events. Events should be scheduled from morning until evening all weekend long. It's just a dull atmosphere right now.
View it as part of our cultural heritage, as a place of learning and enrichment that is efficient enough to pay for itself. Do not regard it primarily as a potential cash cow. You will kill the goose that laid the golden egg, in the sense that the transformation and growth of the Torpedo Factory led the way in the transformation and growth and beautification of the waterfront -- which is finally approaching the goal of being open to the public along its entire length -- and more visibe and usable.
To some at the City, and you know who you are: Quit being so nasty to the artists, management and staff of the Art League and Torpedo Factory. They are, for the most part, hard-working and accomplished artists who are eager to engage the community and the world through art. I've met some of the most caring and wonderful people there. You should cherish the treasure you have in your midst. Just the manner in which the survey was worded says a lot about you, that you really don't understand the impact The Art League and Torpedo Factory have on the community. "Once a month" was listed as the least number option for visiting the Torpedo Factory, when it may seriously underestimate the number of times a community member goes to the Torpedo Factory in a month. Wow. I hope you are not using the results in any statistical manner, because just the way it was put together would lead to erroneous results. Very unprofessional on the City's part. Still, I'm glad a survey was done at all. Usually it hasn't been done, when needed. Thanks.
More classes for Teens
Don't fix what isn't broken. The Torpedo Factory is a wonderful place that attracts tourists and adds to the unique flavor of the Old Town waterfront area.

<p>Torpedo Factory is a great space and a great place for art. We have purchased many items from artists for our home over the years. However, it can feel stale and neglected because the artists never seem to change. There should be a 5-year rotation or something like that, with 20% of the artists changing every year. Another problem is that very few of the spaces are open -- you have to go to another studio and have them let you in. Then if you want to try to negotiate on the price of a piece, that gets awkward over the phone or by email. I get that artists are out making art outside or going on trips to the beach, mountains or foreign lands to create or get ideas for their art, but that leads to a lot of empty studios during business hours. If there was some way to better mitigate those circumstances, that would probably be helpful for the artists who would actually like to sell their art! I would like to see more 3-dimensional art, such as ceramics, being produced on-site. I would also like to see more opportunities for Art League students to exhibit and sell their art.</p>
<p>Be careful. Make it better. Improve it. Please don't change it too much. Please do not make it something that tourists are more interested in than residents.</p>
<p>It is a cultural landmark and an important arts program. Please don't take that away from us citizens!</p>
<p>Having the City run the factory doesn't make much sense. The City's assistance (providing discounted rent, facilities needs) is much appreciated, but a government is a big, lumbering entity to be trying to run a comparatively little art center. The Factory is already being stifled by the bureaucracy. It needs to be returned to self governance (assistance from a management firm, like suggested in the artist's plan, sounds like a great idea), and soon, before it loses the flexibility that makes it special.</p>
<p>Break out of the past and chart a new course that makes the art center activated, beautiful, welcoming, engaging, immersive, with high quality compelling work that reflects the highest practices of the field today, not yesterday. Embrace the waterfront and program inside and outside the walls. Reorganize inside of the building so that the amazing waterfront views on the upper floors are more accessible to the public and leveraged as event spaces to increase revenues. Partner with creative placemaking developers and restaurant groups on a rooftop restaurant / event space and help make other enhancements to bring more vibrancy to the building and to generate earned revenues.</p>
<p>So many of your options for improvement would make a difference. You almost can't go wrong with the ones you pick! However I definitely think that rotating the artists more frequently would be beneficial. Perhaps you could do 1-2 year residencies. You could let people apply again after a gap year.</p>
<p>Take advantage of waterfront location with outdoor cafes/wine bar/etc. Add more excitement!</p>
<p>Right now, the TFAC does not serve the city or the community. We are supporting shopkeepers, and it would be better to use tax dollars to support less, but serious, focused artists. It would be great to give more artists a chance to win fellowships in the TFAC so the artists can change.</p>
<p>Strongly support the Torpedo Factory, its mission and for its contribution to the community.</p>
<p>Don't mess with success. Keep it fully funded.</p>
<p>There are already many restaurants and cafes in the Old Town area. Doesn't make sense to get rid of something unique like artist studios for things we already have a lot of. The city's uncertain/vague plans have caused a lot of stress among artists and art league students. It has also caused some really good artists to leave. Since the City has taken over the management, the bathrooms stink and never seem to be adequately clean.</p>
<p>More events that will bring more attention to the facility</p>
<p>All studios remain consistently open keeping similar hours to other retailers in Old Town. Exception being major holidays or federal snow closings</p>
<p>MORE ARTIST RELATED LECTURES LIKE JOHN SINGER SARGENT BY HISTORIAN RICHARD ORMOND, EXCELLEN!</p>
<p>Diversity of art and artists is important. Inclusion of art-making areas for City of Alexandria kids. Less pressure to make the space financially profitable. The space serves an important function to artists and</p>

community.
Plan to keep it a living space with creativity and engagement of visitors. Keep nourishing and encouraging a variety of creatives through subsidized space, facilities and resources.
Support the torpedo factory. Provide parking.
Have studios covered during normal lunch hours and be OPEN for business.
Better marketing to the community. More appealing attractive outdoors area
The Torpedo Factory is an important arts destination for both out-of-town visitors and local residents.
The Torpedo Factory seems to be working fine. I don't see the need to improve it. Perhaps set evening hours once a week? Food is readily available nearby, so vending machines are adequate to meet the need for something to drink. Just put tables out so people can take a break. Only regional artists would want to work in a studio at the TF, so it does not matter to me if artists are from Alexandria or Oxon Hill or Springfield. Studios should be for artists who will work there, which should rule out artists from outside our geographic area.
put on a roof top restaurant/bar later hours on weekends
I understand the City's concern about diversity, but artists should be selected based on the quality of their art, as judged by other artists, without regard to age, gender, or ethnicity. The City should allow the artists to determine what should be shown in their studios and in the hallways and what artists should reside in which studios. Their creativity and inspirations are what make the facility interesting and unique, and should not be smothered by administration and the desire for revenues. The City should instead focus on public art displayed throughout all of Alexandria.
Keep the artists working and focus on art innovation and don't make it like a mall, keep it vibrant and focused on art.
Art is an important part of Alexandria's culture.
Keep its location. Give artists a significant say in its running and future. It makes Alexandria unique. There should be a pref. for area artists.
First - Keep it open! -Do not remove the Torpedo Factory. Are there more kid friendly events that can take place not the waterfront vs on Madison? Is there a way to have more community driven events in the evenings?
Yes, the Torpedo Factory is the City's most valuable asset. Don't value it based on the real estate. Don't move it elsewhere. Don't push out older artists. Let the artists run it. Stop trying to monetize it at a new level. There is food all around it, food is not needed. Don't use up artist studio space for food. Don't put in cheap/fake art just to increase sales. Usually each artist has high end things and affordable smaller things. The TF shows Alexandria's heart and authenticity. It keeps us real. Don't make it like the art festival on King Street, keep it more like Art on the Avenue - real, authentic art by local people who work in studio. We are the envy of the art world.
I do think the torpedo factory is a very important element of the old town waterfront. Important to both locals who have chosen an old town residence for walkability/culture/community and as a unique attraction for tourists and visitors. The torpedo center could be the jewel in the crown of the old town art scene and believe it is important the city facilitate the arts in our community ... but Torpedo Factory falls way short of that: - no sign of organized development and fundraising efforts - obvious tension between city/art league/artists - lack of coordinated community outreach re programming and education - Poor day to day management: i.e., facilities dirty/out of order, event staff not onsite during events and no one with real oversight or authority present during evening/weekends TFAC is a fantastically unique environment/destination that is resting on the laurels of its location and the beauty of its calidescopes of artists because of lack of coordinated leadership, careful management and strategic direction.
The city needs to consider putting a variety of uses in the TF beyond the current art studios and

individual artists. Supporting arts and culture is an important part of ALX's quality of life, however, the TF is a highly under utilized asset on our waterfront. The fact that a small cadre of artists have an oversized influence on what happens in the facility is unfair to the taxpayers of our city and other groups who would benefit from using this space. I would support a mix of publicly supported and private (or paying nonprofit) uses in the building. I think arts and archaeology should be included in this mix of uses. Restaurants, with the potential to utilize the outdoor space facing the water, should also be considered. Further, I would support the city entering into a public-private partnership to run the facility. In this scenario, the city could retain ownership but lease the building as a form of generating revenue to offset the capital costs associated with maintaining the TF. I do not support keeping the building as it's current use as the programming and shops/studios do not align with my preferences, interests, or income-level. Thank you for conducting this survey.

The exterior of the building is boring. I understand that the city is strict about exteriors but the building could be more inviting.

Don't have bad quality for low costs. Offer children's birthday parties even Paper Source offers this. Offer art for Girl Scouts and Boy Scouts badges with the ability to try out different mediums, like rice paper and ink, or enamel. Offer help to low income children to take art classes, one of my children took many classes and it was a blessing to have these choices in our community. Keep up the high school internships. Thanks

Art is important.

I love it and want it to stay in Alexandria - it is an amazing place!

It is an important part of our community and needs to continue and further engage people both within and outside of Alexandria

Keep the art Center which is unique to this metropolitan area and add a first class eating area to give the building a high energy atmosphere. Maybe have a wine bar for some evening events.

While I don't necessarily think the Torpedo Factory should be a profit center (although it would be great if it could be), it should be at least revenue-neutral, environmentally sustainable, and an incubator for all kinds of art, both low and high-brow. I could definitely appreciate more uses being incorporated into the building's first floor that helped to make it a bit more inviting to pedestrians as well. From a foot traffic standpoint, I feel the entry along Union can be very forbidding

The City itself should have as little to do with running the Torpedo Factory as possible. It simply does not have the expertise or resources to be actively managing it.

ARTIST SURVEY COMMENTS SORTED

Why TFAC is important to Community Identity – Non-Affiliated Artists
Without the Torpedo Factory, Old Town would be nothing but retail, restaurants & residential buildings. Sure, there's a certain visual appeal in our period architecture & and waterfront location, but the Torpedo Factory provides a resource & a destination that sets Old Town apart. In fact, I've met professional artists from other parts of the country whose communities have used the Torpedo Factory (and the Art League) to model their own art centers.
While it's important to manage and cultivate Alexandria's identity as a historic city, history alone is insufficient to maintain a modern economy and tourism base. An arts-based identity contributes to both the well-being of residents and lures tourists to focus more on Alexandria as a whole than just a history corridor.
variety of mediums showcased
Tourist destination place for residents and tourists to learn about and buy art (including art featuring Alexandria) shows that Alexandria includes and promotes talented persons. Showcases Alexandria's high quality of life
This enables the art communities to share their experiences and skills as well as being tourists to the city.
There is always a diversity of work flowing through the factory. One can always depend on it to be there to inspire, challenge, and celebrate people and work from within and beyond the community.
The visibility and influence on the public to encourage tourism and associated retail art venues. Opportunity of developing artists to improve on their skills and sales. Supporting the tradition of Alexandria as an art conscience and friendly venue.
The unique and welcoming spirit in a historic site. It perfectly encapsulates the visual and emotional aspects of Alexandria.
The Torpedo Factory showcases hundreds of local artists in one historically important location to both locals and tourists who would otherwise never be exposed to said artists' work. It also inspires and educates new generations, standing tall as a monument to the artistry of past and present residents as well as proclaiming Alexandria's commitment to all arts.
The Torpedo Factory serves as an arts destination for both local residents and visitors. It also provides a space for artists to share their work. It is a unique resource.
The Torpedo Factory is the heart of the city. Alexandria is listed nationally as an artist-friendly community, with a high percentage of artists living in or near the city. When people visit the city, the Torpedo Factory is usually the goal, with dining and shopping after that. Every town in the country has dining and shopping. Not very many have an arts center like the Torpedo Factory.
The Torpedo Factory is one of the most well-known sites in Alexandria and attracts many tourists and artists. Combine this with the history of the building, the local artists who work there, and the classes offered to the community and you have a space that is unique to Alexandria.
The Torpedo Factory is not only a place for artists to work and share in community but also a place for visitors to Alexandria to learn about the history of the city (torpedo factory) and meet local artists and purchase artwork.
The Torpedo Factory is an important Alexandria landmark that not only highlights its artist talent but also cultivates new talent in the arts via the Art League. Housing artist studios and guilds such as the enameling guild in such a historic building preserves its identity while educating both residents and tourist on its historic importance. Special gallery exhibits and special children's events expand the appreciation of the arts and bring more residents and tourists to downtown Alexandria after which they browse the shops on King Street shops and catch a bite to eat at one of its myriad of restaurants.
The Torpedo Factory is an iconic structure and its history as a community-developed art center makes it a model. It is a magnet for visitors and residents alike.
The Torpedo Factory is a very unique arts venue with an unusually large, flexible space that can

concurrently accommodate vastly different programs. It's arguably not meeting everyone's needs at the moment, but its national presence is an asset and it has the potential to evolve into a creative hub, given long-term planning and thoughtful guidance.
The Torpedo Factory is a unique institution. It provides an important destination for tourists coming to Old Town and demonstrates Alexandria's commitment to artists. We should have more spaces like it.
The Torpedo Factory is a unique art space. Its presence in Old Town is an important part of Alexandria's cultural base. Do we want Old Town to become nothing more than tacky shopping and restaurants?
The Torpedo Factory is a great place--attracts artists, tourists, and students and offers a wide variety of artists for visitors to view their artwork.
The Torpedo Factory is a flagship institution that is one of the first things people think of when I say I live and work in the City of Alexandria. Without having the Torpedo Factory as an art hub, the City would lose much of its importance for residents and non-residents.
The Torpedo Factory has drawn artists and those who appreciate art together for many years. It is a vibrant, zestful, beautiful space. It is known to people all over the U.S. and abroad.
The Torpedo Factory draws tourists to Alexandria, offers art classes and supports artists. I think it is a huge draw for Alexandria. I have friends who live outside the city who come for classes & to view exhibits. They usually combine a trip here with other shopping and eating in Old Town.
The Torpedo Factory Arts Center is a major cultural anchor for Alexandria, in particular Old Town. It's a connection to the City's past, present and future through the wonderful use of space highlighting the buildings historical function during WW II and its 40 plus years using the space for creativity and celebrating culture. Part of that includes the Art League's instrumental role in fostering an artists' community spanning several generations and age groups. The Torpedo Factory and Art League were the primary reason in deciding to live in Alexandria when I moved to the area 23 years ago.
The skilled artists that work and sell there. The vast amount of high quality instruction in the arts that are available to local residents and tourists.
The resurgence and branding of Old Town in the 1970s is tied directly to the efforts of the Art League and other citizens to create the Torpedo Factory. It's existence as a non-commercial physical entity, subsidized in part by those who live and own property in the City, where creativity is celebrated and those who create are respected sends a strong and tangible message that creativity is in the City's DNA.
the only local place that offers glass classes
The history of the Torpedo Factory. That a building that once produced weapons now produces art from our community.
The history of the building, the interaction of tourists with local artisans near a very populated street and riverfront
the history and support
The Factory is an important artistic center in this area because it is the only place that offers year 'round access to artists and classes that are accessible to me. I also take visitors there - it is a must-see stop whenever anyone comes to town and repeat visitors want to go each time to see what is new and see their favorite artists and purchase art. Alexandria would just be another old town with generic stores were it not for the Factory. Others venues I've visited in other states just don't hold a candle to the Factory and I know the Factory was the model for them. The Factory also cements Alexandria's identity as an artistic center - welcoming to artists and creates a vibrant, creative atmosphere to the Old Town area.
The creative part of the city's history and culture cannot be overstated. As a focal point for tourism and interest, the Torpedo Factory and Art League combine to facilitate a growth of fine arts culture that has become known as more than just a local community institution.
The creative arts are an important part of Old Town Alexandria's identity. The Torpedo Factory with its unique history and environment provide the stage for local artists to display and sell their one of a kind creation. This venue stands out against the continuing downtown onslaught of franchised vendors one

can see in almost every US city and town.
The community of fellow creatives; the Target Gallery's injection of fresh contemporary work into the city; the monthly Art League gallery shows by local artists; the variety and scope of the art classes. It's a priceless part of Alexandria's identity.
The combination of the Torpedo Factory's 20th century history and the way it has been transformed to house local artists, spotlights different aspects of Alexandria's history and cultural life. It's a meeting place and a focal point at the waterfront. It's nice to know that a place that once made torpedoes for a war is the home to Alexandria's artists and The Art League.
The city is very widely known for this nearly unique asset!
The buildings history and archeological offices. Plus, the artist studios and school.
The arts are an essential necessity to not only Alexandria, but to society as a whole. Having a close-knit community center like the Torpedo Factory validates our creative citizens and promotes their artistic abilities.
The Arts always bring sophistication, knowledge and beauty in the humanity of its residents as well as the sensitivities of their physical surroundings.
The Art League makes art a central focus of the city, and serves as a draw for artists and those interested in art. This allows the artist communication try to grow and develop and nurture new waves of artists and art enthusiasts.
Supports the arts and local artists and inspires future generations of artists
Sparked development of Old Town and anchors business area. A unique, historical space that highlights local talent and makes creativity and art education an integral part of the local area.
seriously, if you have to ask where you have lived? community and cultural hub I have traveled a lot thru the U.S. and every art center has come to study the Torpedo Factory
resource for both artists and community
Reinforces that art is part of the fabric of the community
provides depth and keeps us from being totally commercial in nature. Art heals. Art expands the mind and heart. Art builds community.
Preserves a historic building, consolidated gallery space to work from many different artists,
People who visit Alexandria come for the Torpedo factory
Out-of-towners who visit me in Fairfax County want to go to Old Town to see the Torpedo Factory. Its beautiful waterfront location is definitely part of the charm, but the studio-visiting itself is irreplaceable, and hard to come by anywhere else in the country.
Opportunity for everyone- tourists and locals- to see local art and interact with local artists. Opportunity for local artists to exhibit and interact with the public. A chance to show that Alexandria has a cultural as well as commercial identity.
One of the things that attracted me to Alexandria was its reputation as a creative space to help others learn, grow and share art.
One of the primary draws to the region, a crowd pleaser - shopping, art & history entwined
Old Town is very well known for its art presence through the Torpedo factory, and the Art League School. It draws many visitors and artists alike.
Offers a more human dimension to the City. Connection opportunities with others through creativity and common activities. Art is a positive, attractive endeavor involving a wide cross-section of the population.
Many people who do not live here know the Center and have visited it.
Many people from outside the area use it for art instruction and for inspiration. It draws many outsiders to the area to see favorite artists as well.
makes a statement that art is a priority for Alexandria
location
Living history and the power of a transformative space, which also is an anchor to the community

Lively art center.
Large venue for art in the city shows that Alexandria values art and culture
Landmark space, central location, historic, connects to local artisans
Key historical location and art center. The location helps makes it a must-see for visitors to Alexandria. All my family members want to visit the Torpedo Factory when they are in town.
Key destination and represents the creative culture of old town
It's well known nationwide. Arts are important in attracting people to the area, both to live and visit.
its location on the waterfront; the building's history; it's a tourist destination
Its location
It's an icon on the waterfront and keeps Alexandria from being just another town...the vibrancy of the arts community in Alexandria keeps it real and interesting and a nice place to live and be creative.
It's uniqueness.
It's unique purpose as a gallery, a community of artists, a part of Alexandria's outreach programs, an educational venue for families/tourists, and a visually vibrant center in Old Town.
It's the center of the local art community. Also, its prominent location makes it a focal point for Old Town.
It's the best-known art institution in the area and a large draw for Alexandria. Also, through The Art League, it is a cornerstone of the art community in and around Alexandria.
It's something unique to Alexandria.
It's one of my favorite places in Alexandria and a reason the city is unique.
It's in all the tourist brochures and it's a historic building.
Its history as a torpedo factory and that it is now used to generate creativity, it is one of the top spots I always take out-of-town visitors and they love it!
It's gorgeous and fun
It's distinctive and gives the public an opportunity to see and interact with artists both local and beyond. The torpedo factory also offers classes which are beneficial to the community.
It's an original concept of having numerous actual working artists in one place. Good location on the Waterfront.
It's an artistic and creative hub that ensures Alexandria's unique character and cultural relevancy.
It's a well-known, established venue to look for unique handmade products and gifts.
It's a key historical site - which makes it even more interesting as an artistic center as well. Love the mixture of art & history.
It's a huge tourist attraction. It's distinctive, historic and a wonderful part of the community. It inspires and captures our past while projecting possibilities for the future.
It's a historic landmark and a cultural hub of Old Town.
It's a great draw for tourism...it allows people to mingle with 'everyday' artists/people...it inspires others - especially children - to be creative and explore the artist within.
It's a gathering place. It also fosters creativity.
It's a driving force in the arts community in Alexandria. The variety of classes appeal to many in the city.
It's a destination for people to see and experience art
It was the first thing I heard of when I mentioned I was thinking of moving to Alexandria, and one reason I moved here.
It shows that the city is committed to the arts, that art is an important part of the city's identity.
It shows Alexandria's cultural side. Most people only think about presidents and history when Alexandria is mentioned. These days the subject of our country's history is definitely a touchy subject, but art can bring everyone together on a different platform.
It provides a real nexus for art, artists, the community, and visitors in our Area. It is both historical and contemporary in its relevance. It is unique to our area.
It provides a needed respite and offers great opportunity to speak with artists and see original artwork.

It offers opportunities to take classes and share ideas easily with other artists. It's also wonderful to be able to view a variety of work.
It nurtures and encourages art and art appreciation in the community. It also has a historic importance and is a major attraction for tourists.
It is unique and something DC and other cities do not have. I do think it needs more variation in the artwork that is sold there currently.
It is THE venue for visual arts!
It is the heart and soul of the creative arts in Alexandria.
It is the center of life along the waterfront. It draws tourists and locals alike. As an artist I have taken classes at the Torpedo Factory, I take my guests there, it's close to restaurants and nightlife.
It is the #1 place I take friends/family when they visit Alexandria. We love meandering, looking at art and talking to the artists, and then catching a bite in Old Town.
It is symbolic of where the city came from and how it's transformed.
It is supportive of the local arts, it's an important resource for artists, and it's a huge draw for tourists, which benefits both the city and the artists themselves.
It is such an inspirational place! I love its origins -- the fact that it was an actual place where weapons of mass destruction were made and now it is home to so many creative minds! And I know that it is a model for other cities and countries worldwide! It's one of the first places I take my out-of-town guests to see!
It is one the greatest lures drawing people to Old Town Alexandria. You can find chain shops and restaurants in any mall and on any street in America. The Torpedo Factory is unique and provides 100s of artists the opportunity to show and sell their art. The quality of the art and the number of artists located together in one place is unique and astonishing. The ambiance of the Old Torpedo Factory adds to the overall quality of the experience. Add to that, the Art League School and art supply store residing there and you have something so special that it is difficult to over-estimate its value to the City of Alexandria.
It is one of the largest art centers of its kind.
It is one of the country's top community art spaces. I have traveled extensively in America and always visit the local art spaces. The Torpedo Factory I have compared to other city's or towns art venues. I find it is a high quality valuable component to Alexandria's appeal as a livable community for its citizens and visitors.
It is in an historic building and is large enough to house studios, classrooms, and galleries. It is next to one of the major shopping streets which helps bring in viewers and customers as well as students. The only difficulty is affordable parking.
It is important to have an artistic outlet for artists to create and also promote/sell/display their work in a central location.
It is important to Alexandria's identity because it is a place where tourists visit and has a strong reputation in the area.
It is both a home to artists and an attraction for visitors and residents alike.
It is and has been a destination in Alexandria for the arts.
It is an unusual space to see living artists creating and selling their work.
It is an incredible, accessible resource for local artists. I value the opportunity to visit and learn from other artists, to ask questions, to attend events, and to take classes at The Art League.
It is an anchor feature in a prime location that shows Alexandria's support not for just retail operations but as an arts community.
It is an amazing collection of talented artists! It brings locals and visitors to Old Town.
It is a world class visual arts venue that provides an excellent opportunity for people to take classes as well as exhibit. It also is extremely important in giving those who love art to connect with people with similar interests. It is the single most important thing to me here in Alexandria, and the reason for me to

remain into my retirement. Without it, I would move away.
It is a wonderful tourist attraction and a nice place to hold parties on the main floor. It is an educational center for those who wish to explore different art mediums and a great place to purchase unique gifts and items for our own homes. It has a history all its own that no other city can top.
It is a wonderful open space that shares Alexandria's artists' creativity with the public.
It is a well-known artist community. It is popular. It is a focal point for tourists as well as residents when spending time at the waterfront.
It is a visual landmark of the art community and provides access to both locals and tourists w a vision of our arts community and talent. We need to be more visible in doing that for public do art is valued by the bigger Society.
It is a vibrant artistic community that anchors Old Town as a destination and supports artists in many ways.
It is a very visible, active community of artists whose presence encouraged my move to the city. It is also a wonderful display/practice/sales place to meet and talk to other practicing artists.
It is a very important historical space that is now open to the public and being used in a very appropriate way--bring arts to a community and area of Alexandria that is otherwise very commercial and increasingly dominated by non-local corporate sales venues. Being filled with and supporting the local artisan community through contact with locals and tourists keeps the area, increasingly suburban-ified and soon to be over-developed, a unique vibrant neighborhood. It should in no way be developed and closed off to the general public, that would not serve the community.
It is a unique resource in the Alexandria area.
It is a unique place, one that sets Alexandria apart from other places. I've lived in various parts of the country, and no place compares. It is one of the first places I take visitors when showing them town. Universally, they are impressed (and jealous).
It is a tourist attraction and brings many people to Old Town restaurants and stores. We need better signs on Washington Street and King Street so tourists can identify Alexandria with the Torpedo Factory.
It is a top attraction to visitors (artists and non-artists) - my guests ask to go there without me telling them about it! It makes Old Town a top-notch place to visit and a place to want to come back to again and again - too much of the town is becoming cookie cutter (retail stores are more and more just chains). The Torpedo Factory is a constantly changing reminder of the city's history and a fresh take on creatively enjoying today. The history of the building makes it uniquely a part of Alexandria's history and a highlight of Old Town.
It is a staple of artwork in the area and I think because of its presence- art continues to grow and expand into the community.
It is a representation of what I think is a thriving art community. It feels like the home of the arts in Alexandria.
It is a recognized feature of the community. It is something other communities do not have. It brings people to Alexandria and it creates a community of artists.
It is a place where Alexandria breathes. When I have people from out of town staying, I take them there. I meet friends there to browse before a late lunch on the weekends. My neighbors have studios there, and I love to visit to support them. The Torpedo Factory is unique to Alexandria--there is literally nowhere else in the area you can go to have the same experience. I never leave there without seeing something new that makes me think a little differently.
It is a place to meet artists, talk with them about their work, and support them through purchasing their art. It is also an important destination for visitors as it is a unique experience to Old Town beyond the usual restaurants and retail stores you find everywhere.
It is a part of Alexandria's WWII history.
It is a lovely building and a unique, authentic working arts space that grounds the City.
It is a large artistic venue; a face for Alexandria's art scene.

It is a home for local artists to create and sell Art. It is a tourist draw.
It is a focal point on the waterfront for residents and visitors. It provides an opportunity for people to see art as it is made and to talk to the artists -- a living art experience rather than a static experience of buying art without interaction with the artist. The Torpedo Factory Art Center is well established and well known both nationally and internationally and thus raises Alexandria's profile in the U.S. and abroad. Losing the Torpedo Factory as an Arts Center would significantly reduce, if not remove, the arts as a part of Alexandria's identity and character.
It is a focal point of the waterfront and an important way to educate the general public about the arts.
It is a destination to explore and find inspiration for my design. I also love taking my kids there to enjoy art days and meet real artists.
It is a destination for locals as well as tourists.
It is a destination filled with real, local artists where local residents and tourists can come together to enjoy art, to buy art, to walk near the water, to play with children and learn about archeology.
It is a cornerstone to the fabric of old town. There is nothing like it anywhere.
It is a community center, shows Alexandria's commitment to the arts, and is a tourist draw
It is a central location and a public face of the city. It brings people to the city who are interested in other things besides history and dining.
It is a central focus of the city's geography, history, and is easily accessible to artists and patrons alike. It has been around a long time as a well-known place that celebrates the love of art and the artistic contributions of Alexandrians.
It is a centerpiece of Alexandria's culture. Alexandria without the Torpedo Factory as an Arts Center would simply not be Alexandria to me at all. Whenever I talk to anyone about why I love this city I start with the Torpedo Factory.
It is a center for visual and intellectual stimulation, entertainment, education, and serenity. The ability to enjoy viewing artist create and work at their craft is an experience unavailable elsewhere so close to my community. The caliber of the artists provides enlightenment and inspiration. It is a wonderful attraction for visitors. It is the jewel of Old Town Alexandria.
It has taken a facility of historical importance to the Community and turned it into a facility that can be enjoyed by the entire community. It is also an attraction for visitors to Alexandria - those from near and far.
It has been a mainstay of growing up in Alexandria, I have attended many classes throughout the years
It has become synonymous. Additionally, the opportunity it provides for artists and patrons.
It has become a known place for residents for classes, purchasing of art, education for all ages. It is a known destination for out of town visitors and tourists who also can see the city not just as a place with a colonial history but as a thriving creative community. It offers a place to appreciate and purchase art of all styles and affordability.
It has a long reputation as a working and retail space for artists which is unique to the DC area. It's also a physical end point to tourists walking down King Street which keeps them moving and supporting other retailers.
It has a great Legacy of supporting art and artists. It needs to have more accessibility for the community and to attract visitors from other regions.
It feels like one of the keystones of Old Town, where you can actually spend a significant amount of time browsing the artist studios and seeing the occasional performance.
It enhances the City's reputation.
It enhances our culture.
It draws visitors from far and wide. It is a key attraction for locals and tourists strolling through old town. The Art League School has world-class instructors.
It draws tourists to the city and is an important place for artists to connect and learn.
It draws tourism and is very well known around the country. It is one of the first places my out-of-town guests want to see. It also elevates the city in terms of culture.

It draws people into town, encourages a blend of new innovative thinking in our historic city, provides an example of making the old new again.
It distinguishes us from other historic areas, such as Georgetown and Capitol Hill. It makes Alexandria a destination for a significant group of tourists, and it makes it more interesting for residents.
It connects people to art and shows that art plays a vital role in the Alexandria community.
It connects artists to the public. It supports artists. It is an innovative and exciting space for artists to create. It creates excitement for the arts in the public mind and heart.
It brings visitors and they can see artists at work in a very special environment. It supports classes for all ages. It is exactly what makes Alexandria special and not just an historic city.
It brings people together and is a destination point for both residents and tourists. Nothing else like it in the surrounding area
It attracts visitors and tourists to the historic district. It provides space for working artists and an opportunity for others to be inspired by seeing artists at work. It provides space for a school of art, open to all! It provides a place to show and sell art to the public. It creates interest and a relief from restaurants, bars and traditional retail establishments.
It adds to Alexandria's historical identity and brings together a large number of people.
It adds an important dimension to Alexandria, enhancing our culture and quality of life in our community.
In terms of art, Alexandria cannot compete w/ D.C. as far as museums. It would be difficult for Alexandria to compete w/ DC as far as galleries. Where it can -- & frankly probably already does -- outrun D.C. as far as art is in creating a central, always open & accessible place that draws people in to see *local* art. I bring up D.C. obviously because of its proximity, but also because I lived in D.C. for 20 years. DCCA is a nice resource, but it is not one physical location where one can go to see local art, & DC is not an easy place to live & be an artist. The Factory is offering something that the Capital of the US, a few miles away, isn't offering to local artists -- a local venue to show & sell that is not a temporary fair or popup shop. D.C. also barely offers any studio space (I know because I rented studio space in D.C. & left after repeated flooding was preventing me from working there), which is another thing the Factory does & another way the TF has become something that is distinctly Alexandrian. Finally, I think the TF is a draw for younger folks in Old Town, where (I have read) that most visitor money is spent by an older demographic. If the TF continues to be a draw for all ages, it means that Alexandria's identity as a city is appealing to all ages.
I've rarely spoken to anyone about Alexandria without some mention of the Torpedo factory. Arts in any community are so important and we're extremely lucky to have a place like the Torpedo Factory in our city. It's one of Alexandria's most important differentiators in my opinion.
I send visitors there. It is unique, I believe.
I remember visiting the Torpedo Factory in middle school and when I moved to Alexandria after getting married it was the first place that I visited. It provides a unique and inviting space for all to seek inspiration and knowledge and I can't imagine Alexandria without it. It's a true differentiator for the city of Alexandria.
I love that they have taken a piece of history and turned it into a space where artists can create, connect with each other and the community and sell. The space and artists are unique and keeps Alexandria a little funky. The location on the waterfront allows both community members and tourists to connect with more than just colonial history, but of living pieces of our lives.
I have lived in Alexandria for 30 years and the Torpedo Factory and the artists inside of it have always been a place I could go to be inspired to do my own work or take classes to help me improve myself. It was started by an Alexandria resident who believed in the historic preservation of the building, much like the other buildings, and streets, all over Old Town. It is central to Alexandria's identity as it serves as a community building space.
I believe it is the Torpedo Factory is what sets Alexandria apart from other small historical towns.

Alexandria is one of the top arts destination in the country because of the Torpedo Factory. Art centers around the country use the Torpedo Factory as a blueprint.
Holds the space for educational opportunities and buying local.
History, location, fabulous artists using the space.
History and culture, as well as opportunities for community classes and exhibits.
Historically, the Torpedo Factory had a major part in the revitalization in the Old Town area of Alexandria. Additionally, I think it's important to have an arts center in any city or town.
Historically significant and enhancing contemporary arts community.
Historical site
Historical building repurposed for creative activities.
Historic landmark that lives today as a vital center of the arts in Alexandria, a focus for visitors and anchor on the waterfront.
Highly visible on the waterfront, at the bottom of King St. Major attraction for people who live in and those who visit the area. Truly a community center.
Highlights local artists at work
High quality art. Place to show the work of talented artists for the community to see and purchase relatively inexpensive art. opportunity for the community to participate in art events and take classes from the best.
Having a large arts center on our waterfront sets us apart from other waterfronts, especially with the Wharf and National Harbor, it's even more important to have such a unique draw for tourists and to residents.
Has served a community of artists, teachers and students in the areas of offering classes, work spaces and gallery walks.
Great tourist attraction. Even people who have been there before like to come back to see what kind of art is available. A major reason people come to Alexandria.
Great to see local artists and support them with attendance and purchases.
Great location in a historic building. It is a centerpiece on the waterfront.
Everyone who know or lives in OTX and aware of the art community here, associates the Torpedo Factory with this art community.
Everyone throughout NOVA knows of the torpedo factory. It the only art center of any substance in NOVA
Easy accessibility to visitors.
Easy access, classes of all types, no other city has a similar space.
Defines Alexandria as a city of where art is valued and supported
Culture, tourists
Creative-maker space where artists and the community can meet and experience all types of art
Creative space celebrating community
Contributes to Alexandria's vibrant culture.
Center for visitors interested in arts, students come to Art League classes from entire region because it's extremely good and not prohibitively expensive, location on the waterfront shows Alexandria's identification with the arts, existence of studios with working artists is irreplaceable resource for children -- which brings families to Old Town from within Alexandria and from outside the city
Cannot be Compared to Laguna Beach in CA, however the Torpedo Factory is the only location known for area studies and sales. I feel that Old Town is losing much of its history and appeal, and the Arts enhance it!
Both its history and location in the middle of a retail/entertainment area which draws in people who otherwise might not be disposed to go to a standalone or not so prominent art venue.
Being one of the largest hub for working artists and also home for some pretty important artistic organizations and studios. Along with affiliated programs such as Post Grad and CRAVE.

Because all the artists and people that contribute, work and support the torpedo factory and the art league, they provide, teach and enrich the culture of community of old town Alexandria.
As the top tourist draw for the city, it shows the world that Alexandria has talented, intelligent citizens who create important art (many of the pieces shown there depict the city). It makes this art available for sale to visitors, who then display it in their homes, where it has continual PR value for the city.
As the foundation for development of Alexandria waterfront community, it has been a catalyst for visitors and residents of Wash. region, to visit the Old Town community for a variety of reasons including restaurants, retail, and sightseeing. People all over the country and even world associate Old Town with Torpedo Factory. It is a drawing card unlike any other.
As someone who grew up in the area it's synonymous with the spirit of Alexandria, I've always known it as a place for artists and teachers to connect with citizens
As an art center, cultural center, opportunity for tourists, fabulous place
As a primary location for area meeting others the restaurants etc only exist near around the location it is the focal point.
Arts brings visitors
Art, festivals, farmers Market, parks, trails,
Art connection
art
Any place that allows artists to become accessible to the public is important. I think the Torpedo Factory could be better utilized as a community space to make it less of an artist market and more of a community partner.
An important counterpoint to the constant money-grubbing drumbeat of the City of Alexandria; a quality-of-life necessity.
Alexandria's cultural and social life gives the city its special flavor, especially attractive to those who live in Alexandria but also for visitors who want to explore its active art life. This is what Torpedo offers.
Affordable center for new and professional artists. I cannot imagine the city without it.
Affordable art classes
accessible display of variety of artists and makers throughout the area
accessible and committed arts space and public venue for both classes and retail art
A unique space, working artists, in heart of Old Town
A place to attract folks visiting where they can witness art being created.
A historical building that allows artists to create their visions. It is in the heart of the city's entertainment district which allows access by all users and onlookers.
A great space for artists to work and the community for classes and viewing/purchasing local art. Also, a tourist draws in a historical setting. The high school internship program was helpful to my child.
A central place of arts-important for community and tourism
A center of artists!

Advice from Artists not affiliated with TFAC
Yesterday I stated in this survey that a student at The Art League School had been sexually assaulted and harassed with impunity. I was very pleased to hear from that student this morning. She informed me that the school staff intervened on her behalf and has resolved the situation to her total satisfaction. Kudos to the school!
Yes- My husband and I have lived in Alexandria for more than 6 years (homeowners at 22301 and my husband lived there for 10 years total) but because we have moved to our summer home for the summer and are currently renting an apartment in 22305 zip, the survey structure did not allow me to answer the questions as a long-term resident. The Torpedo Factory is one reason we are remaining in Alexandria.
Yes- as discussed, every studio should be open 100% of the time when the factory is open. Closed studios are a real bummer. It's so hard to get juried in and then you can't get space because of the system. The sublet space system is abusive to newly juried artists.
Without the Torpedo Factory, Alexandria would be just another town with chain stores. So many of the locally owned boutiques and restaurants leave town because of the expense and lack of city help. The Torpedo Factory is unique and the City should treasure it.
What is the Art League's mission? Art? Rec center? Amusement park? Money-maker for City? AL needs administrators with rigorous, professional experience. Students are currently treated with condescending paternalism. Their concerns are ignored or dismissed. AL needs to raise the tone and quality of art works, introduce some rigor. Art League needs to up its fundraising game from parochial, dependence on volunteer work of students, TA's, team members. (AL exploits students with show entrance fees and 40% take on sales and insulting fees for left work.) We live in one of the most prosperous, educated sophisticated areas of this country -- wealthy professionals and rich industries galore, internationals. This is the capitol of the USA! Think about corporate sponsorships. Be creative with fundraising. Think about the international community. Think about the high percentage of foreign students attending Art League classes.
We need another one
This treasure is the reason I live here and plan to remain in Alexandria when I retire from my federal job. I hope then to take several Art League classes at a time and work full time as an artist.
This is one of the best studio/gallery spaces/communities I have ever seen, and I have traveled all over the world. It would be a very great pity to repurpose this space.
This is a unique space. I feel it makes a city more vibrant to include working artists in the community life. Perhaps offering art experiences to children ex. birthday party in space allow more people to learn about the TFAC. I have taken my children to 2 birthday parties at Paper Source to give you an idea of the popularity of this type of thing. Only other option is the Paint This ceramic,
Think big picture. An indoor gathering, creative and educational space that is accessible is rare in the US, especially with so much focus on revenue-generating property development. Those are unique offerings that TFAC provides.
There are probably a lot of cities that would love to have something like the Torpedo Factory. I would hope that Alexandria doesn't ever choose to diminish the impact the Torpedo Factory and art has on the city
The Torpedo Factory should be kept as an artists' facility. It is well known around the region and the nation and is a great draw for tourists and would-be residents. Even if people don't spend all their money at the Torpedo Factory it draws them into town where they spend their money supporting the other businesses as well. It is difficult to quantify the benefit to the local community. However, the Art League and Torpedo Factory are one of the reasons I have lived in Alexandria for 52 years! I was first a student as child (in adult classes, as that was all that was offered and I was an excellent artist). I remember sweating in the factory in the summers, with turpentine fumes all around, before the building was renovated. I still take classes and meet new artist friends. Please keep it open for all who dream of making art!

The Torpedo Factory needs more diversity and a better jury system. It's not fair that large guilds can let in whomever and have dozens of members when local artists could use that space. Also, some artists have been there for years with the same tired art. There's no incentive to sell or produce shows to keep their art fresh.
The Torpedo Factory is wonderful -- it's why I moved to Alexandria.
The Torpedo Factory is open to all and it should not be made to reflect any specific demographic.
The Torpedo Factory is indispensable to Alexandria's waterfront. It is a part of this city and the city should not bow to developers wanting to change that space.
The Torpedo Factory is an important feature of Alexandria. It differentiates Alexandria from other locations in the DC area.
The Torpedo Factory and Art League is the jewel in Alexandria's crown. It sets Alexandria apart from other DC locales and the fact that it is right on the waterfront makes it that much more valuable! I love having it as part of my community and brag about it regularly to visitors. It makes us more than just a historic destination (there are so many of those in the area) and sets us apart as a unique and eclectic locale
The TF can be a profit venue that benefits local area artists and the community as a whole. Perhaps the city should ask for proposals to run the TF in a profit manner since cities and governments are not strong in this area. The location makes it a great attraction to old town specifically, as a place to enjoy and expose more persons to various forms of art in a very unique way where interaction with art creators is encouraged. I don't think it should be limited to Alexandria artists, but should be limited to local area artists (it would be sad to see artists from outside the VA-MD-DC area take up space because then it would lose part of the sense of community).
The classrooms could be cleaned up. We desperately need new easels and -- very important -- lights. Artists need lights and there are very few available that are not broken or have burned out light bulbs. This is really basic and shameful that more isn't done in this area.
The City's continuing uncertainty re the Torpedo Factory is creating anxiety. Some really good artists have already left the space. It feels like the City does not appreciate how many people the art league and the TF pull into the area. These are people who might not otherwise come into Old Town. The restaurants and stores that line King south of Fairfax are not that unique.
The Center generally and the Art League specifically are essential to the city and its cultural life and artists' community
The art of transformation is the theme of the Torpedo Factory. Creative energy can transform even tools of destruction into a place of art.
The Art League School pays salaries to student staff who sexually assault and sexually harass the students with impunity.
The Art League is a real treasure. There is no place like it. Excellent classes, a great venue for exhibiting artists, wonderful sense of community.
Thanks for your support
Take better care of the facility and its artists. It is a gem!
Sadly, I have recently had to relocate because Alexandria City was TOO expensive to be an artist and make a living. This came particularly into the inability to rent a cost-effective studio space and purchase an affordable place to live in the city. This made me quite sad after spending a decade in the city. Unfortunately, the city does not maintain an environment that is artist and small business friendly. I look forward to visiting in the future and hope that the city can solve its affordability crisis soon.
Restrooms should be upgraded with artwork and or designs by community artists. Though I have eagerly wanted to, I haven't been able to afford to take classes.
Require artists to circulate through the Torpedo Factory studios on a regular basis, say every 3-5 years. There are many entrenched artists who are grumpy, unproductive, and unwelcoming that act like it is their space rather than a shared public space.
Remodel the annex to improve the class rooms. Do not move it out of Old Town. Thanks for asking residents to participate in this survey.

Relative to question #25, I believe Alexandrian residents should generally be given preference - perhaps some percentage. Also, perhaps some studio space could be set aside to young Alexandrian residents and/or minorities which could be shared and/or in which they could form a coop of sorts to better afford the space???
Provide free or reduced parking for visitors
Please keep the Torpedo Factory!!! Don't turn it into apartments or condos!!!
Please keep the Torpedo Factory! Adds quality of life to the city
Please keep supporting and increase support for this institution. The arts are so important and we need to support them now more than ever.
Please don't turn the Torpedo Factory into more condos. I mean, really--enough with the overpriced specialty condos. Parking and lighting would be nice at night.
Please don't make it harder for artists to share their craft.
Please continue to support this wonderful place and resource for artists.
Please allow the Art League to continue operating their programs in Old Town and in the Torpedo Factory. They keep art classes affordable and are a great resource that brings multiple generations together.
Parking is difficult, maybe a stamped parking pass on the dashboard would help.
No other cities have a place like the TFAC.
Nope, just keep it around. It would be a shame for a vibrant space full of creativity to become just plain old shops and restaurants.
No.
No
No
No
No
No
No
No
no
no
N/A
My sense is that the Torpedo Factory has long played a vital role in making Old Town a destination in a region with no shortage of attractions. It should be a considerable point of pride that we are a city which nurtures both art and artists.
My classes are in the Madison Annex, not the TFAC, but I can tell you there is nowhere I would rather teach than at the Art League.
More public art/sculptures outside the Torpedo Factory and in Old Town would be wonderful. Outdoor art really brings a city to life.
more parking
Many artists have been there for decades at low rates when they are selling their work for hundreds or thousands of dollars. They have become successful and should move on to selling their work through galleries or online. I feel strongly that there should be a limit as to how many years an artist can have a studio in the Torpedo Factory. This would free up space for new artists to have studios.
Many artist studios are closed when I visit.
Make sure it remains an integral part of the city. And please ensure the art league school accessibility is retained
Make it work!
Make art accessible and advertise in schools.
Love that I can introduce my daughter to art here in town in many ways. We just need more walls and space to display art at home.

Love it, don't ever let it go, make it better. It is truly a shining light for Alexandria.
Keep up the good work!
Keep it!! Art needs support. Life is hard and people can be mean. Art provides beauty and solace in a cruel world, and space to create art provides a creative outlet for people otherwise trapped in a mediocre existence.
Keep it!
Keep it going for many years to come!
Just that it needs an updated interior. It feels as if it is stuck in the 80s or 90s, not very exciting to be there. The large animals in the main area (hallway, breezeway?) must go. Seems as if they have been there a long time.
It's a great local resource and tourist destination. Please don't destroy it as an art community.
It's a fun place to visit but not sure if it's the right place to support upcoming artists. I'm not a member but I heard it's very hard to even get into the exhibition space because hundreds of people apply (and like I stated before not sure if it really makes sense). I wish there would be some type of affordable venue to showcase your artwork/prints and re-direct people to your website. Or maybe even promote it somehow online where there is a lot of online traffic.
It's very unique and important, please don't mess with it and break a good thing!
It's one of the reasons I enjoy living in Alexandria.
it's a vital part of the community for me, a resource and an inspiration. There's not really anything like it nearby, because it is a working facility, not just a gallery.
It's a unique, well-known, well-regarded facility. There are so few places that you can go to see dozens of working artist studios, along with opportunities to learn and show and buy art. The addition of the gift shop and restaurant makes it an easy destination for individuals and families alike.
It would be a great loss if this was not funded or supported.
It would be a disaster to eliminate it.
It seems very political in that there is little opportunity for an artist to have small work space unless it's a friend of the existing artists working there. Candidly I see artists who have their own space copying pictures from books which is not original art...and they are selling it. And these same artists want to vote new artists in as members. Perhaps this whole process should be evaluated.
It is truly the jewel in Alexandria's crown and its location on the Waterfront makes it an extraordinary boon to the city. It is like a living magnet attracting tourists and locals alike. Only fools would disrupt the delicate balance that gives birth to this unique artistic phenomenon.
It is one of the gems of a city that is rich with historical sites, but without the Torpedo Factory, with few major artistic sites. I don't think the City could have a more valuable tool for attracting visitors and at the same time serving the citizens of Alexandria. Almost every member of my family has taken an art class at one time or another. Friends from out of town often ask to meet us there before doing anything else in Old Town. Please don't change it too much. If you try to change it to use it too much as a cash cow you will ruin its reputation and its powerful allure to outsiders and residents alike.
It is interesting to now realize that people come to visit Alexandria not only for its history, charm and restaurants but for slowly becoming an art center. Torpedo Factory is its heart.
PLEASE KEEP IT ALIVE!
It is great that the City supports artists at the Torpedo Factory. It would be even greater if the City created additional artist studio space in other parts of the City. Sometimes I sense that the Arts Commission is more interested in purchasing art ('public art') than supporting artists - but any City can buy art. The great City will support artists.
It is great and important that the city of Alexandria is home of these artists so they can teach and develop art to enrich the community and the world.
It is an informative educational institution and I value it very much. Please continue to provide this space to artists.

It is an important cultural center that draws people to our city.
It is a vital part of the City's waterfront, and a regional art draw. The city should highlight it and celebrate it.
It is a treasure.
It is a big part of quality of life here in Alexandria. I would spread the word more about the classes offered. I believe almost everyone has an artist inside of their soul, and may not know about the wide variety, or the reasonable cost of the classes offered.
It has been a main introduction to the arts for so many persons I know who live in the city.
Intentional engagement with people with significant disabilities.
in exchange for subsidized studio space, the artists should have a community engagement requirement.
Improve amenities, like moving the cafe to an upper floor on the riverside and expanding it as a destination for lunch or afternoon tea. Move the studios around or have an overview gallery featuring the work of artists and rotate often. Create a space to highlight how art can enhance your living space to help educate young people about the value of art and handcrafted objects. Do targeted exhibits about the evolution of a technique and how it has evolved over the years, such as photography.
I've talked about this with artists both here in Alexandria and elsewhere. My impression is that the TF is seen as a place for an older, established, entrenched community of artists, some of whom are original studio tenants. Maybe it's time to shake things up a bit.
I'm considering leaving the area due to the small number of artistic outlets for glass and jewelry.
I would love to see the Torpedo Factory continue to provide studio space for artists and showcase the best art in the area for people to see! I don't think it should matter if you are a fine artist or an illustrator or if you make a craft . I think it should be a place to showcase all types of art.
I would like it to continue as an art center, because Old Town already has retail, eateries, and commercial venues. I think that's why residents and visitors continue to come-- to see local art conveniently located.
I would hate to lose the TFAC as it is now. I think it is one of the things that draws people to the waterfront. It is difficult to make a living with art, and it is wonderful to have such a place as this. There is too much sameness these days, and the TFAC offers a variety of experiences that is unique because of the individuality of each artist represented there.
I think the Torpedo Factory is a terrific arts venue and we have purchased many items there for thousands of dollars over our course of living in Old Town. However, it can seem stale because the artists don't seem to rotate out very often and sometimes studios appear closed or deserted for extended periods, so it can be difficult to gain access or then negotiate about a sale price for a piece or pieces. We have literally had several times when we had to negotiate with the studio partner or minder because we were offering to purchase multiple items and wanted a discount; that was a little weird.
I think the Torpedo Factory is a linchpin of attracting tourists to Alexandria, providing art classes, and making a statement that art is important to Alexandria. I can't think of another single attraction in the city that is as likely to draw people to the City & the waterfront. The Torpedo Factory should remain an integral part of the waterfront, and artists who work in the Torpedo Factory should have a significant voice in operations.
I think it's what makes Old Town Old Town.
I think it is an important symbol of the city. It brings visitors who are interested in art to eat and shop here.
I think it has improved over the last few years. The interior could be brighter and cheerier looking.
I really think the Torpedo Factory has turned into a cabal of artists that don't produce much work and never turn over studio space, and I've discussed this with members of the art community. It has grown stale.
I really like the SOHO program idea, although I have never helped. The Art Center doesn't do a good job informing the community of opportunities in the arts for low income residents or immigrants. I think they may, but I don't think the people know the programs are there for them.
I really apologize if my responses came across as harsh. I love the idea of the Torpedo Factory but I wish it

<p>had a variety of artists to include younger, indie artists. I'm not one to complain and not offer to help, so if bringing in a more indie art scene is something that appeals to the torpedo factory, I would love to help achieve that. I am a very successful Etsy artist (over 5000 sales) and have participated in shows like Crafty Bastards and NPR's All Crafts Considered and have even launched a ran a successful show in DC in 2014. Feel free to reach out to me... (artist provided name and email)</p>
<p>I love the history of the Torpedo Factory. I remember when it was an unused space that a group of artists transformed from its former use as a torpedo factory to a place of art. The city eventually transformed it further while keeping some of its original feel. Sadly, we have seen the rise in this country of more violence, competition and greed and sometimes have forgotten those values that make us human and humane. Art and artistic expression is a way to slow down, ponder and inspire and nurture our spirits. As The poet Robert Broening once said Art was given for that . Lending our minds out .</p>
<p>I hope the City appreciates what a treasure it has in the Torpedo Factory Art Center, in the history of the building itself, and in the Archaeology Museum. The Torpedo Factory is unique and the City should take pride in it.</p>
<p>I have lived and traveled in many cities, and the Torpedo Factory is as nice an arts venue as I have ever seen.</p>
<p>I have been taking pottery/ceramics classes through the Art League for going-on 5 years. These classes, the Art League, and the Torpedo Factory have become a very important part of my life. I feel extremely lucky to be a resident of Alexandria and to have access to such high-quality teachers and such a welcoming community.</p>
<p>I find the above questions (28-31) misguided at best.</p>
<p>I feel that it would be a great loss to liquidate the Art Center, I also feel that the Madison Ave. area is in need of complete revamping...Also, unsafe for classes at night!</p>
<p>I didn't know how to answer the question about whether I thought it was important for the artists to be Alexandria residents. On the one hand, it would be great if artists who are spending a few months in the area to create new art could get workspaces. On the other hand, I want to see those resources go to Alexandria artists. I also would like to know whether low-income artists are able to rent space on a sliding scale, as they are able to afford it. That's something I'd really like to see, to make sure that Alexandria's true diversity is represented.</p>
<p>I appreciate the civic minded volunteers involved in supporting the arts in Alexandria.</p>
<p>great as it is does not need to change</p>
<p>Give local authors a chance to be part of the artful fun.</p>
<p>for question 27: it is important for Alexandria residents to be considered first for the space, however, if there are openings, then residents of surrounding areas should be considered. (we are so close to other townships/cities)</p>
<p>For god's sake, stop the internecine battling between groups. I'll grant you that the Factory has never properly been run like a business but is not what it started as. Now artists want to make a living and the founders were hobbyists or those who did not look to make a living. Change with the times. Have terms limits or reapplication for space to turn over art - limit in categories. Pay attention to the artists who are combining for mini shows that broader the work that is shown, ask those who left for the ideas they presented that died on the vine for lack of interest in changing. Hire someone ALL the groups can trust and have one entity running the Factory, not three competing organizations who don't trust each other. And no, I have never had space in the Factory - I am just a purchaser of art and hobbyist in several media. But I've watched with great sadness what is going on and do know enough artists to have heard the differing views. I read the organizational assessment and recommendations. I would not go there if it turns into a place with generic stores that I can see anywhere. It would no longer hold any interest for me and I'd not spend money in the area or encourage my visitors to do so. We'd have to haul out to Lorton or Baltimore I suppose.</p>
<p>For god's sake, don't look at it as a money maker. Embrace it for what it is, a cultural institution that</p>

elevates the quality of life in the city.
Find a way to stay relevant. It is an amazing space at the end of an incredible street. You're already going to be losing so much to the DC waterfront --we need a performing arts space that is innovative and exciting this could be just the thing to start bringing in
Don't ruin a good thing. Find a way to help the Torpedo Factory Art Center thrive. Consider partnerships with other cultural and arts organizations like Metro Stage and Little Theatre of Alexandria. The event with the 4th Wall theatre company in fall 2016 was brilliant.
Do to even think about getting rid of it and selling it off for a commercial enterprise of another sort It's an icon I've been visiting it and taking classes since I moved to the area in 1985 while still in the military.
Do not sell the artist community short in exchange for revenue for the city.
Do not sacrifice the oldest art center in country for tradeoffs associated with short term financial gains, particularly associated with current retail rental rates in Old Town. What is truly unique about TFAC is that its operating costs (given subsidies by city for rental rates) have been met by resident artists and rental of Torpedo Factory spaces for private events. Believe it would be a mistake to try to broaden its role for Alexandria extensively and try to make it all things for all people and all artistic mediums (performance as well as visual arts). Also, City representatives need to ensure that they differentiate the value and stability provided by full time artists making their living from art (not easy) from those students and part timers, as well as art supporters who have not made, nor are necessarily expected to make their careers as artists. The sustainability of the TFAC depends upon the full time resident artists who are willing to sacrifice many personal hours to ensuring the success of not just themselves, but also the TF Art Center over the long term. It is their life commitment to art which drives their value and work. Variety and artistic multi-disciplines cannot provide the same level of sustainability, even though they may need to be addressed to some degree. Again, dissipating the TFAC roles will weaken its overall contribution and stability in the long run. Comparisons with other Art Centers around the country will confirm this hypothesis. Appreciate the opportunity to provide my voice to this critical endeavor.
Crucial part of Old Town's cultural fabric and attraction. Critical for those who cannot travel, due to mobility or financial reasons, as able to have exposure to art here in old town.
Classes for children that are just one time so they can get exposure to the arts
City should support the Torpedo Factory and allow the arrest to have a majority say on how it is run.
Be careful with good intentions that can be condescending and hurt more people than they will supposedly help.
As I noted above, I see a trend to make the Center more commercial. There are plenty of craft centers and shows around, including the King Street festival and the Del Ray festival in September. The Center is unique because it is not a craft center, but rather an art center. The coffee shop should become a studio again, you should stop closing the center early at 5:00 pm and using it for private parties, and the artists should determine what is displayed in the hallways. It is very disturbing to see the Center commercialized. I'm happy to have my tax dollars used to support an art center that will bring art lovers to Old Town, even if the art center is not a profit center.
As a student taking classes through the Art League for the past 5 years I want to thank the Torpedo Factory and the City of Alexandria for providing such a broad array of classes and summer camps for children.
As a member of the Virginia Writers Club and its Northern Virginia Chapter, I urge you to consider dedicating space to showcase the works of local, i.e., Northern Virginia, authors, including a meeting space for workshops and critique groups. Old Town bookstores are nearly extinct. It's time to reverse that trend by providing space for local authors and their works in the high traffic/visibility area available in the Torpedo Factory.
Arts are vital!!! Do all you can to support the art center...living artists need all the help they can get.
Artists should not automatically have lifetime studio space. They should have to reapply - and demonstrate that they have an understanding that they have the privilege of affordable studio space in

exchange for interacting with the public in a welcoming and educational way and not solely for art sales
Artists should be limited to a 5-year maximum to have a studio in the Torpedo Factory.
Art classes and membership into the association is very costly. Offering Alexandria residents, a discount would be appreciated.
Alexandria artists should have small preference but not at exclusion of better artists that are not local.
A better explanation of the history of the Torpedo Factory what all the rails are on the floor about...
...I am certain that after the dust of centuries has passed over our cities, we, too, will be
remembered not for victories or defeats in battle or in politics, but for our contribution to
the human spirit. JFK

¶

Comments from City Artists Affiliated with the TFAA: What makes it important to Alexandria's Identity?
Well known. Fun. Inspiring. Source for materials and showing
Torpedo Factory is the largest and most visible arts organization in Alexandria. Its central location, extensive classes and active exhibitions make it the anchor of the arts scene here.
This art center represents ALEXANDRIA. It is a well-known establishment. It is located in a historic, unique facility. Like OLD TOWN it is ICONIC. Add to that, it brings revenue to other businesses in the city. It brings visitors from all corners of the world to Alexandria fostering GOODWILL. To be at the ART CENTER and interact with visitors is like being in the world community. The city needs to take advantage of this PEARL on the POTOMAC and promote it as a center of high quality art. This art center has been used as a model for art centers on the east coast and west coast. To have a major art center located in a facility that had been designed for war and now serves the purpose of creativity is a high mark for civilization and an honor for ALEXANDRIA.
There is no other venue within 100 miles which is as good and diverse.
The wealth of knowledge and experience at reasonable prices. It has a reputation beyond the city of Alexandria that brings students and instructors from across the nation to classes. And the classes are all days of the week and night classes
The Torpedo Factory provides the unique experience to visit artists in their studios, see them at work and to see their artwork. The Torpedo Factory programs and Art League school create culture for our town. It is important to know that the artists moved in in the 1970's, helped upgrade Alexandria's waterfront and have created a thriving community of artists inspiring and enriching the lives of all who visit. People come from all over the world to visit the Torpedo Factory artists.
The Torpedo Factory makes Alexandria a destination and makes Alexandria unique.
The Torpedo Factory is the best-known arts venue in the City, and one of the best known in the region. It has a national and international reputation for high quality fine art and fine craft, most of it affirmed by credible jurors. Many visitors to my studio have told me that they are impressed that the City has made the building available for artists and open studios, so I would have to say that it enhances the City's reputation. It is beautifully located to serve as anchor to the proposed arts district, promoting a civic good by making art and art making available to the public.
The Torpedo Factory is an art mecca for the city. Between classes, a distinctive location, a multitude of artists and artwork, it fosters the upscale yet earthy roam and shop feel of the city.
The TFAC is central to Alexandria's identity as a cultural destination. It has been a major player in revitalizing the waterfront and is a main attraction to both visitors and locals. It attracts artists and related businesses to Alexandria to work (and live!). It's the heart of Old Town.
The physical size of the Center, the quality and variety of visual arts disciplines displayed are indications of a community interested and committed to offering rich cultural experiences to its residents and visitors.
The Art League and Torpedo Factory are nationally renowned and as important to the identity of Alexandria as the wonderful historical sites.
Provides opportunities for area visitors to know the artistic talents here in Alexandria.
Promotes art awareness in families and children. Expands community vocabulary and perspectives. Keeps a strong non-tech venue for engagement of the senses. Distinguished Alexandria as a culturally rich community. Provides art resources for the city's many dimensions including schools and exhibits in public spaces.
Opportunities for classes and to show and sell my art and to see other artists. I have been involved in many ways for over 30 years and it enriched my life very much. I would be sad without it. So important
Old Town would not exist without the Torpedo Factory Artists paving the way for gentrification and bloated rents on King Street. A modestly estimated \$47 million dollars is brought into the business of Old Town by visitors that came specifically for the Torpedo Factory. Waterfront and the center have places in people's mind that identify the Alexandria commit to its roots and community spirit.
Main tourist art attraction to the city

Long History and tourist attraction for the Historic town where working or taking classes at the Art League is part of the appeal to the local community.
Long established venue with good reputation for quality art at affordable prices.
It's the number # 1 tourist destination in Alexandria!
It's the main thing that makes Alexandria an arts destination. It draws tourists and locals alike.
Its longevity makes it an Alexandria icon. Repeat visitors and new visitors can benefit. Local residents benefit bringing guests and sourcing artwork and opportunities to attend classes and social events. Its uniqueness brings a current vibe to an historical setting.
It's important in providing an affordable art training and for artist who is not at the gallery quality art to showcase their work. I believe because of that, it expands visual art awareness for the area. I noticed it gains quite a following for people from other towns as well as Alexandria area.
Its historical architectural importance and its importance as a premier art venue in the area.
It's a place the public can connect with what artists are doing and may spark creative ideas in non-artists. The experience of visiting Old Town as an historic site is exciting to tourists and Alexandrians alike, there is always something new to see.
It's a major tourist hub and attraction. It's the most well recognized arts institution in the Washington DC area, attracting people from far reaches of the area.
It promotes art in an historic building.
It is the single best-known art entity in the City and one of the best known in the region, with a national and international reputation. It showcases a broad range of high quality fine art and fine craft, most of it affirmed by credible jurors. Many visitors from around the country and the world have remarked to me that they are impressed that the City has made the building available for art, so I would have to say that the art center enhances the City's reputation. The Factory is beautifully located to be the anchor of an arts district, interfacing with visitors and residents.
It is the paramount art center in the city.
It is the most important part of Old Town Alexandria. It is a destination for residents and guests. It showcases the arts for everyone. Ever changing exhibits in the three galleries (Art League, TAG, Target), opportunities to see artists working; bringing so much to residents and tourists-- beyond chain store retail, chain restaurants. It is remarkable that we have this, when so many cities all over the world are struggling with the loss of their artisan crafts and artisans. We still have it in Alexandria thanks to the Torpedo Factory.
It is the creative heart of the city and touches the lives of thousands of visitors and residents. The Art League is known around the world.
It is one of the most visible arts centers within Alexandria. It draws more tourists than other arts venues within the city of Alexandria.
It is known worldwide and represents the city's core values.
It is known worldwide and is part of the core values of the city.
It is Alexandria's 'gem'. There are not a lot of other cities that have an established arts community that really lead to the revitalization of this city. The longevity of it as an arts community is a huge asset to people who live in the City and to bring in people who may not visit the city, especially as a public/free opportunity to engage and see art, sometimes for the first time ever. It is seen as accessible for not only artists to work, but for the public to see art and have a bit of education as well.
It is a unique resource that provides both work and retail space for artists. It draws people to Alexandria (and really is the hub of what revitalized Old Town). It is a model nationally of how a city can help support and nourish its artists. It is a magnet for other retail business in the area
It is a large part of Alexandria's identity. Many out of towners and out-of-staters associate Alexandria with ART and the Torpedo Factory.
It is a diverse collection of artists who draw in residents, travelers, and artists for exhibitions, classes, and other events. And it is a unique space. Please don't turn it into condos.

It is a cultural beachhead for our city and community.
It is a corner stone in Old Town.
It is a center of art that everyone can visit on a daily basis, somewhat like a museum, with an option to buy a work of art. I look at it as our prime location for people who enjoy art.
It is a center for artists, and a center for tourists. it encourages tourists to stay, to walk around, and above all, to come back to town.
It has national recognition. It's one of the flagship arts facilities in the country. Also, it's listed in Rand McNally atlas as so. It's part of our heritage and local pride! Everyone I talk to from around the country has been there or knows about TFAC.
It has a reputation as a center for art. I know many people in the DMV area who look to The Torpedo Factory as a reason to come to Alexandria.
I grew up in the area and it has been an important cultural institution for as long as I can remember.
Historic landmark, well known location for art
Everyone associates Alexandria with the Torpedo Factory. Check Rand McNally Road Atlas. I talk with people all over America and they have been to the Torpedo Factory.
Cultural enrichment for both residents and visitors. Adds tremendous value to Alexandria as a vibrant community, attractive to all members of society. A resource that brings people into the town for classes and exhibits. Its easy accessibility and visibility for visitors and residents.
As a counterpoint to the incessant push to develop, develop, develop.
Art classes and art student shows for adults and children, opportunities to meet with other artists through art league book club re artists and art, monthly studio walks for public, educational and cultural experience for viewing public, lectures on art. Travel art classes. Free classes for under privileged youth.
Alexandria's Torpedo Factory Art Center is a place where visitors can meet the talented artists from the area and learn about the work that goes into creating their art.
Alexandria residents are proud to have a building dedicated to providing the Alexandria/DC with many different types of art. Many, many out of towners mention how lucky we are to have this type of venue and how they wish their communities had the same. It's so important to have a space where people from all walks of life can work together and gather together to enjoy art.
Alexandria promotes itself as an arts destination. The Torpedo Factory is its biggest attraction. Additionally, the artistic quality is something that the City can be proud of.
ALEXANDRIA IS THE ONLY CITY WHICH HOUSES AN ART CENTER LARGE AND ON THE WATERFRONT. MOST OTHER WATERFRONTS LOOK GENERIC. WORKING STUDIOS ARE MOST IMPORTANT/BUT THE ARTISTS MUST BE OPEN AT LEAST 40 HRS A WEEK!!!
Alexandria -- like New Hope, PA and Asheville, NC -- have a town identity as artist hubs. It makes us culturally relevant and different. We don't sell crappy touristy pieces. This is about artwork.
After history, it is the number one venue that creates the Alexandria brand identity. It is (with the demolition of the Boat Club), the last remaining authentic experience on the waterfront. It has a national reputation unmatched by any other art center in the US.
Ability to educate people and sell art.
? what makes what important? don't understand question/syntax
It's one of the unique things about Alexandria. And as more of King Street becomes corporate chains it's nice to have a unique property anchoring it

City of Alexandria, Virginia

MEMORANDUM

DATE: OCTOBER 12, 2018
TO: ALEXANDRIA COMMISSION FOR THE ARTS
FROM: DIANE RUGGIERO, DEPUTY DIRECTOR, RECREATION, PARKS & CULTURAL ACTIVITIES, OFFICE OF THE ARTS
RE: KING STREET PARK AT THE WATERFRONT PUBLIC ART – ARTIST SELECTION

Background:

In April, 2018 the Alexandria Commission for the Arts approved SOFTlab as the artist for the first temporary public art project at interim King Street Park at the Waterfront. Since then, Mike Szivos with SOFTlab visited Alexandria in June, 2018 and gave a series of presentations, met with key stakeholder groups including Visit Alexandria and the Office of Historic Alexandria, and toured the city with staff and the consultant team.

In September, Mike presented the concept for the public art to the Task Force at a public meeting. Staff has since presented the concept to additional stakeholder groups including the Waterfront Commission and the Parks and Recreation Commission. Groups have been invited to ask for presentations to their groups but none have contacted staff.

Discussion

Per the approved project plan, the temporary public art at Interim King Street Park at the Waterfront will be on view from March, 2019 through mid-November, 2019. The program goals of the King Street Park at the Waterfront Temporary Public Art are to:

- Amplify Alexandria's reputation as an of-the-moment arts destination on the water with a new work of art that captures the public's imagination and is unlike anything else you can experience in the region.
- Highlight King Street Park at the Waterfront as a new civic space that gives prominence to the location where the mercantile city meets the river.
- Bring a new work of art to Alexandria that is informed by the context of the site.
- Foster engagement and interaction with a contemporary work of art on Alexandria's historic waterfront.
- Attract visitors to experience a dramatic, visually compelling and unique work of art.
- Encourage repeat visits with work that changes between day and night or through the seasons.

In addition, the Public Art Program has identified the following internal goals related to the project:

- Take advantage of the interim nature of the site to test out different approaches to public art for this location.
- Create a signature exhibition that raises awareness of the City's public art program.
- Accommodate plaza programming and other plaza uses.

The Task Force reviewed these goals when considering the proposed concept.

Recommendations

The Task Force recommends approving the proposed concept by SOFTlab for the inaugural public art project at Interim King Street Park at the Waterfront.

Attachments

Interim King Street Park at the Waterfront Public Art Concept Proposal

SITE/SEE

9/11//2018



Lighthouse of Alexandria

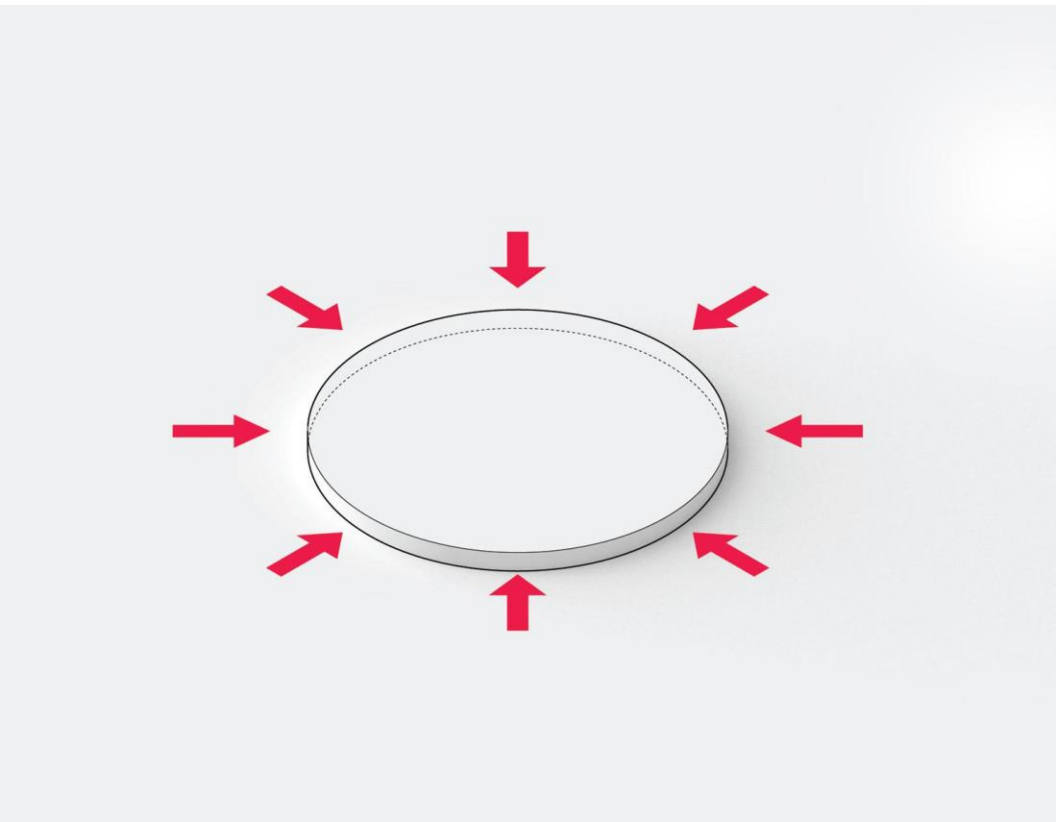

We began by looking at how the shape of a circle can provide a stage in an open area. A shape that does not prefer any side allows for the theatre of public activity to play out through planned events or in unexpected ways.

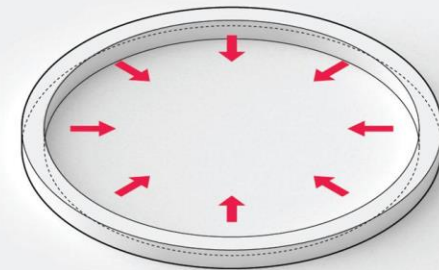

The ring is also a simple form that suggests communal gathering and one of collective communication. The round shape has no directionality and subverts any positional hierarchy. .



Historically, one of the most prominent pieces of architecture that has connected land and sea is the lighthouse. Like a lighthouse, a structure in the round provides a panoramic view of its surroundings and has the potential to be both iconic and ambiguous in its orientation. Outward looking, the lighthouse acts as a beacon of a destination and the end of one journey as well as the gateway to another.

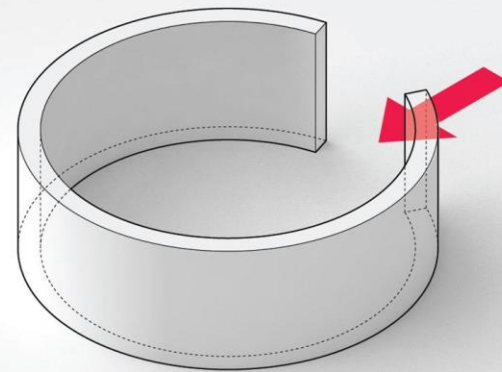

Round architecture has a history of balancing between buildings and pavilions. Often situated as the focal point in plazas and gardens, round structures have been seen as both objects and spaces to reflect upon the surroundings. We have used the entrance to our pavilion as a way to place the circular form on axis with the canopied area as a way to provide a visual backdrop to performances.

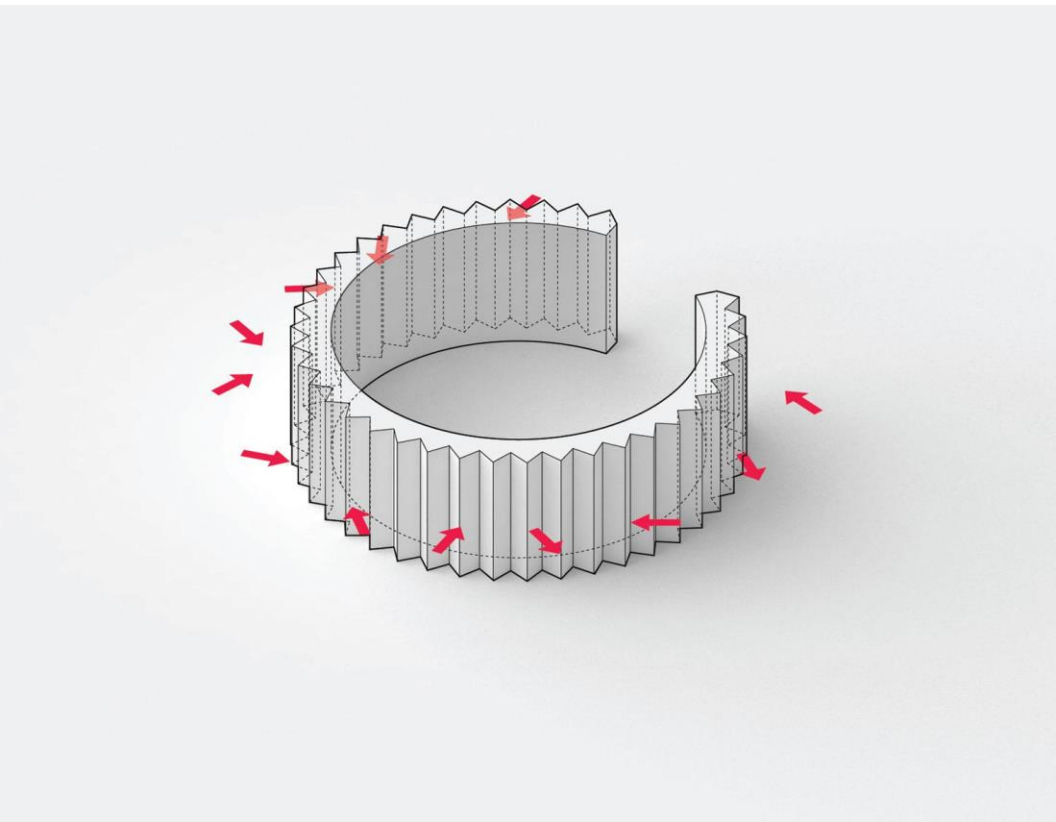

The lens of a lighthouse, the main source of its light, has provided us with the inspiration for the exterior and interior surfaces of our pavilion. We have used the lenticular nature of the fresnel lens to create a mirrored lenticular surface that reflects the pavilion's surroundings in unexpected ways. As pedestrians approach the structure they will see outward rather than inward and as people pass by on a boat the lenticular surface will oscillate between the two angles of reflection. This circular array of lenticular units will be made of one-way mirrored acrylic with an aluminum frame. Each unit will have a vertical LED tube with individually addressable LEDs.

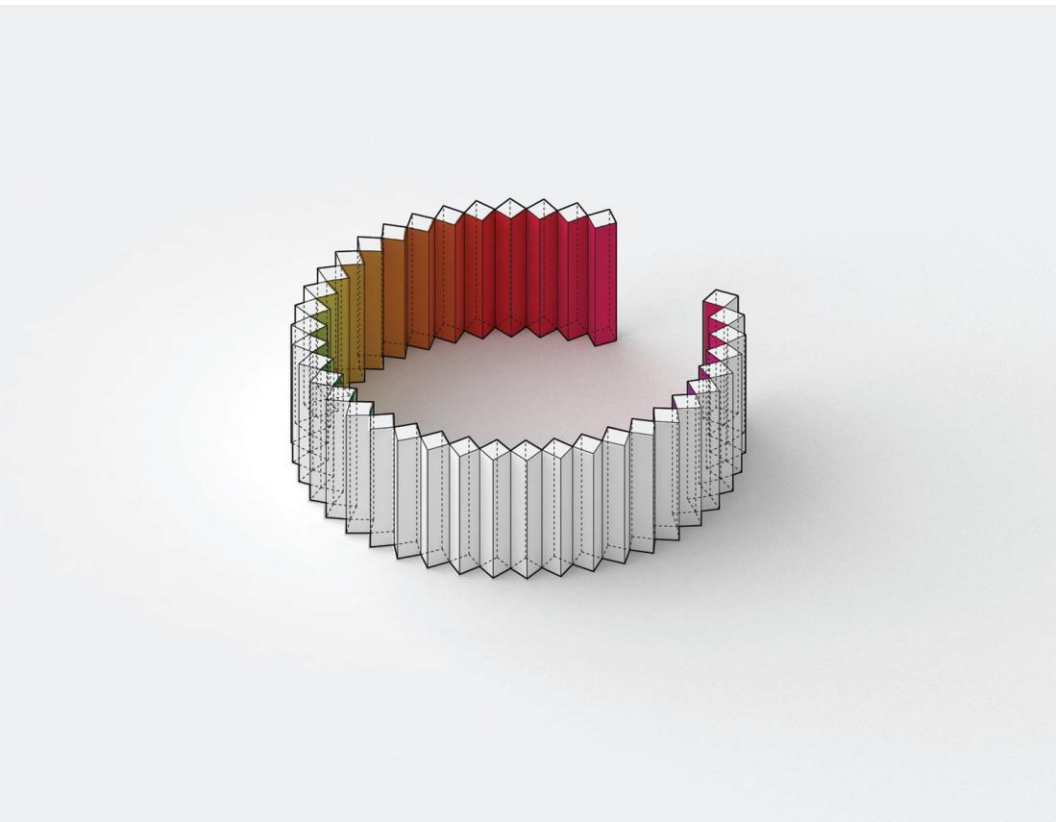

The activation of the LEDs will transform the front facing panels from mirrored to transparent, while the back panels will remain mirrored producing an infinite reflection of the LED tubes, a forest of light. The water facing side will remain monochromatic reflecting the urban environment when not lit from within. The interior will be clad with the full colored spectrum of white light producing an expectedly vibrant urban interior. The LEDs will be programmed with animations as well as respond to sound.

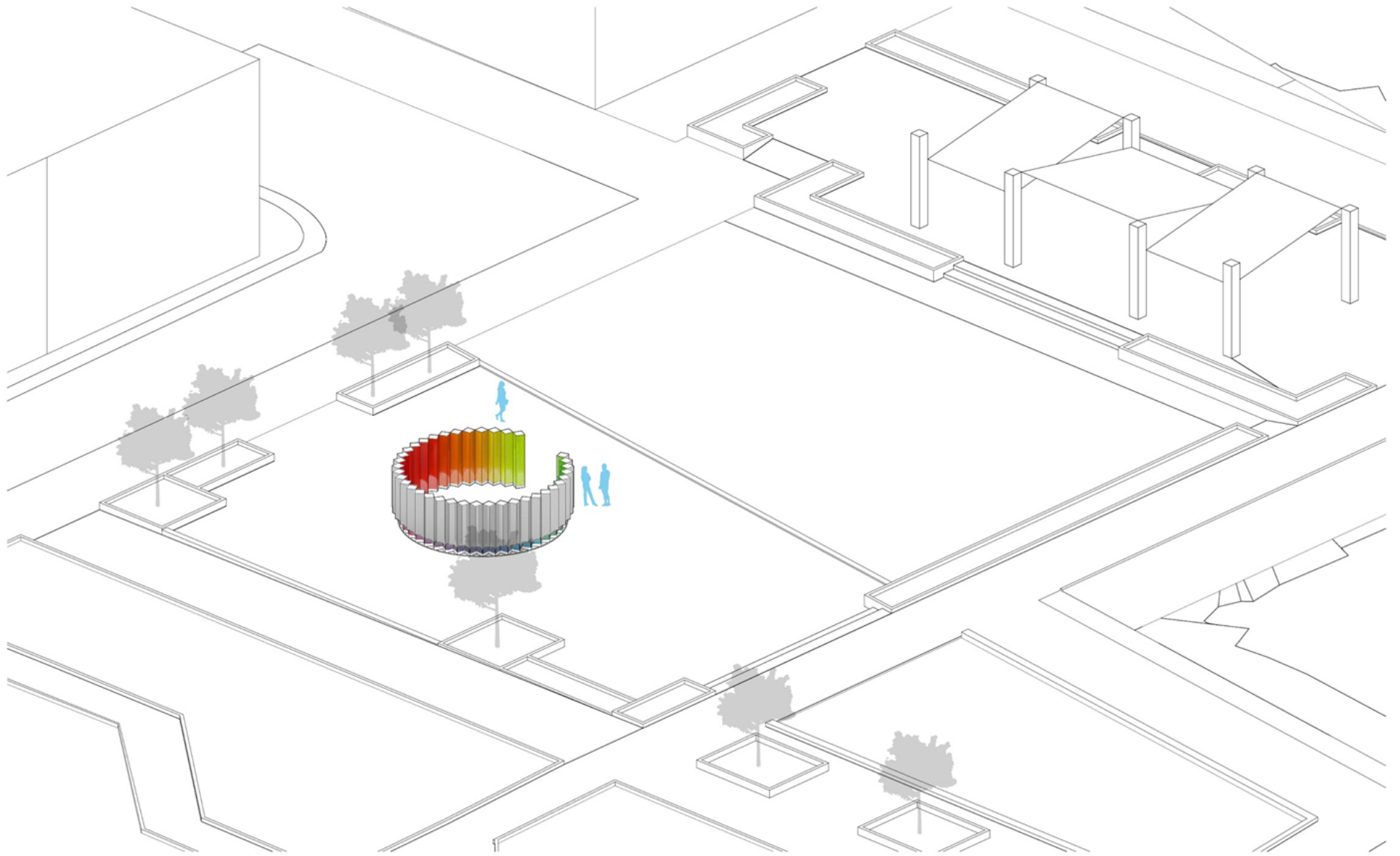

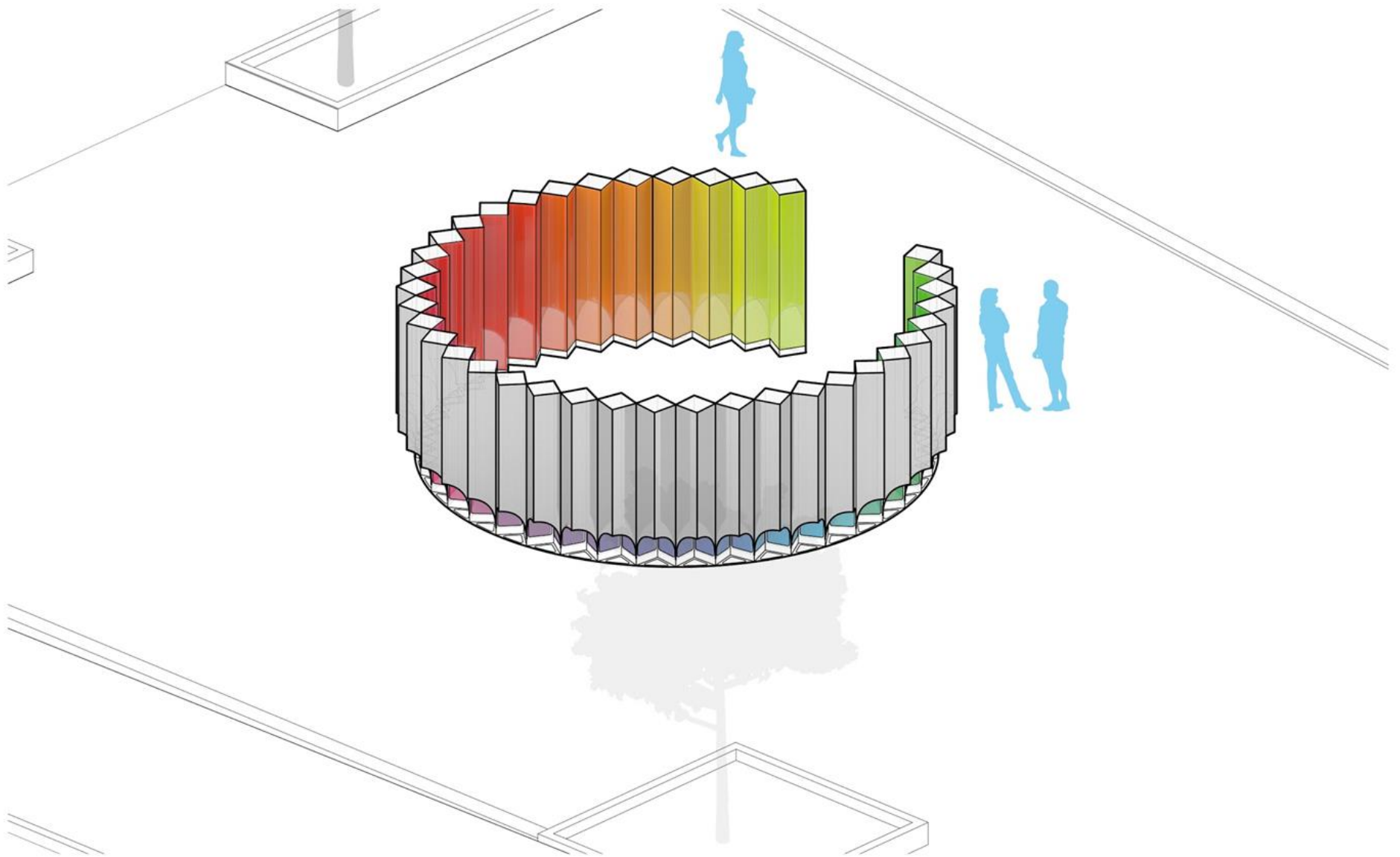

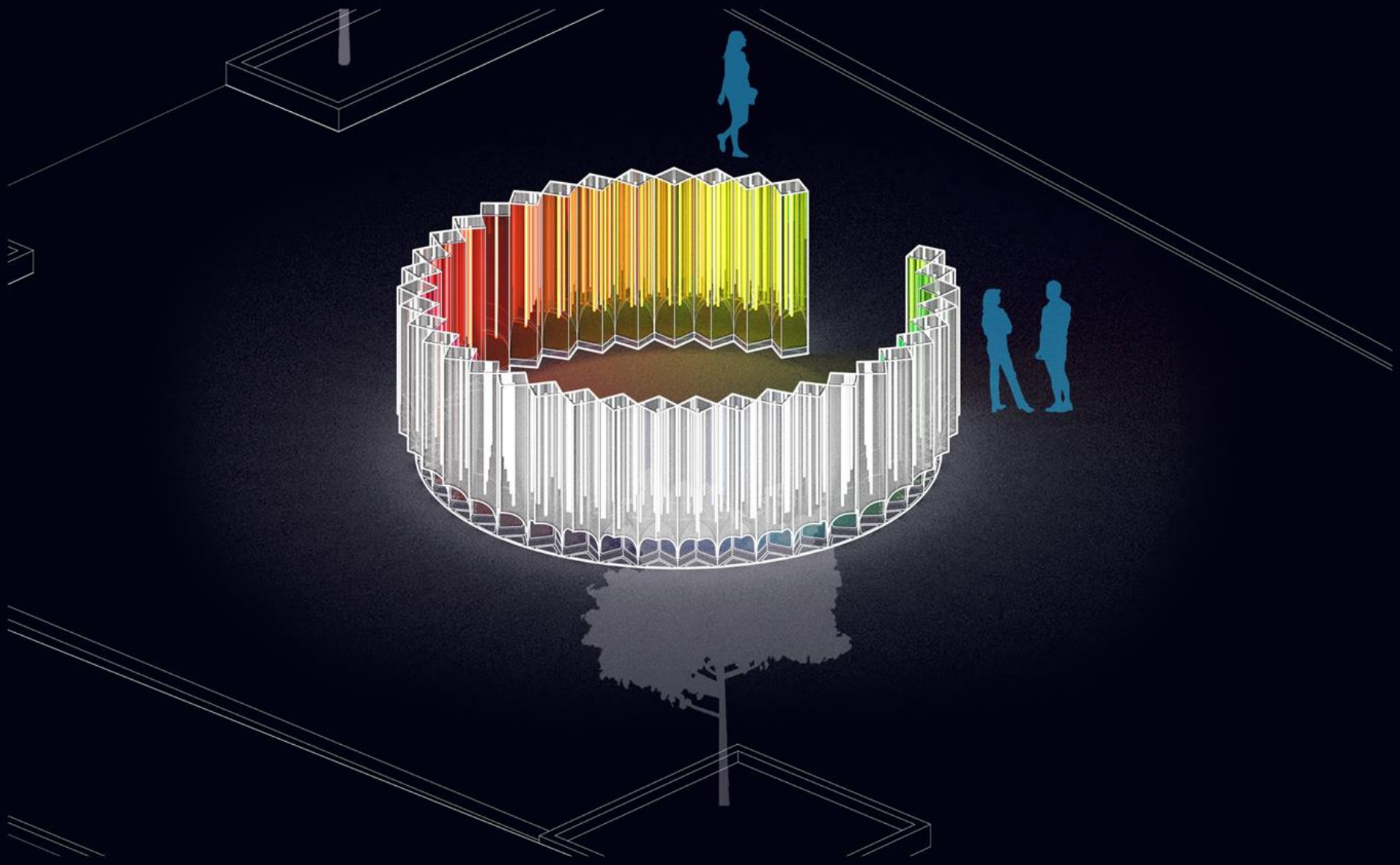

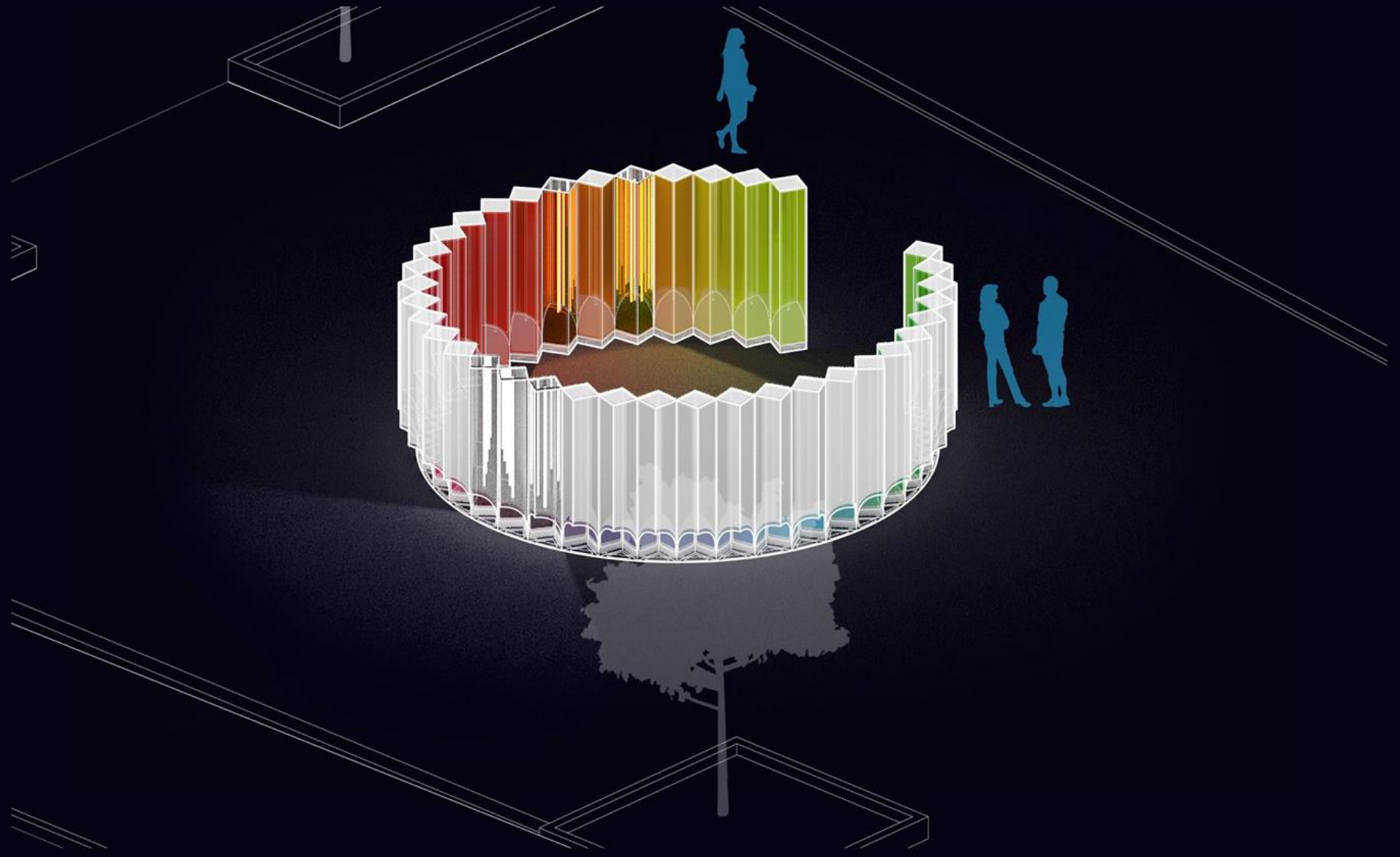

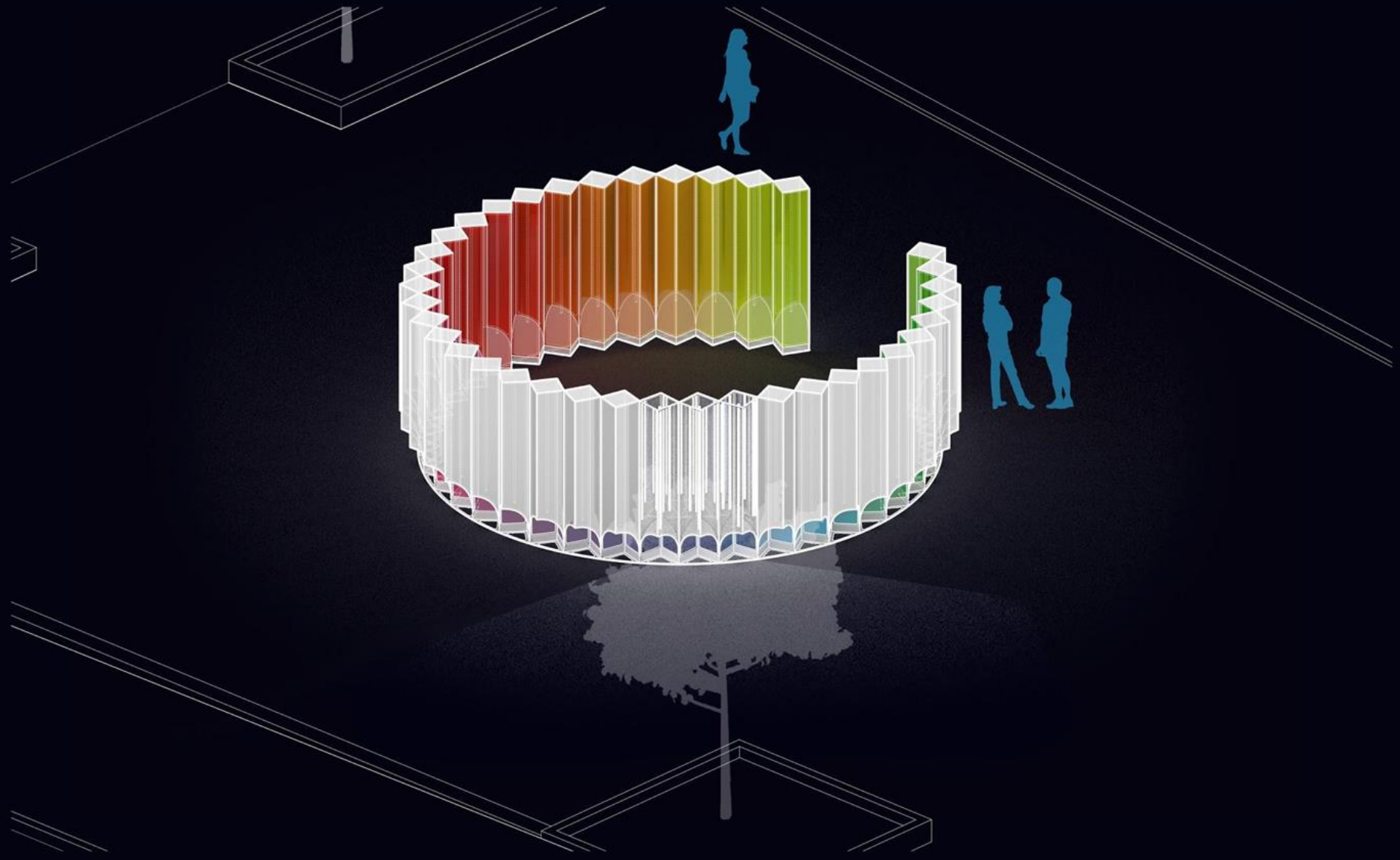

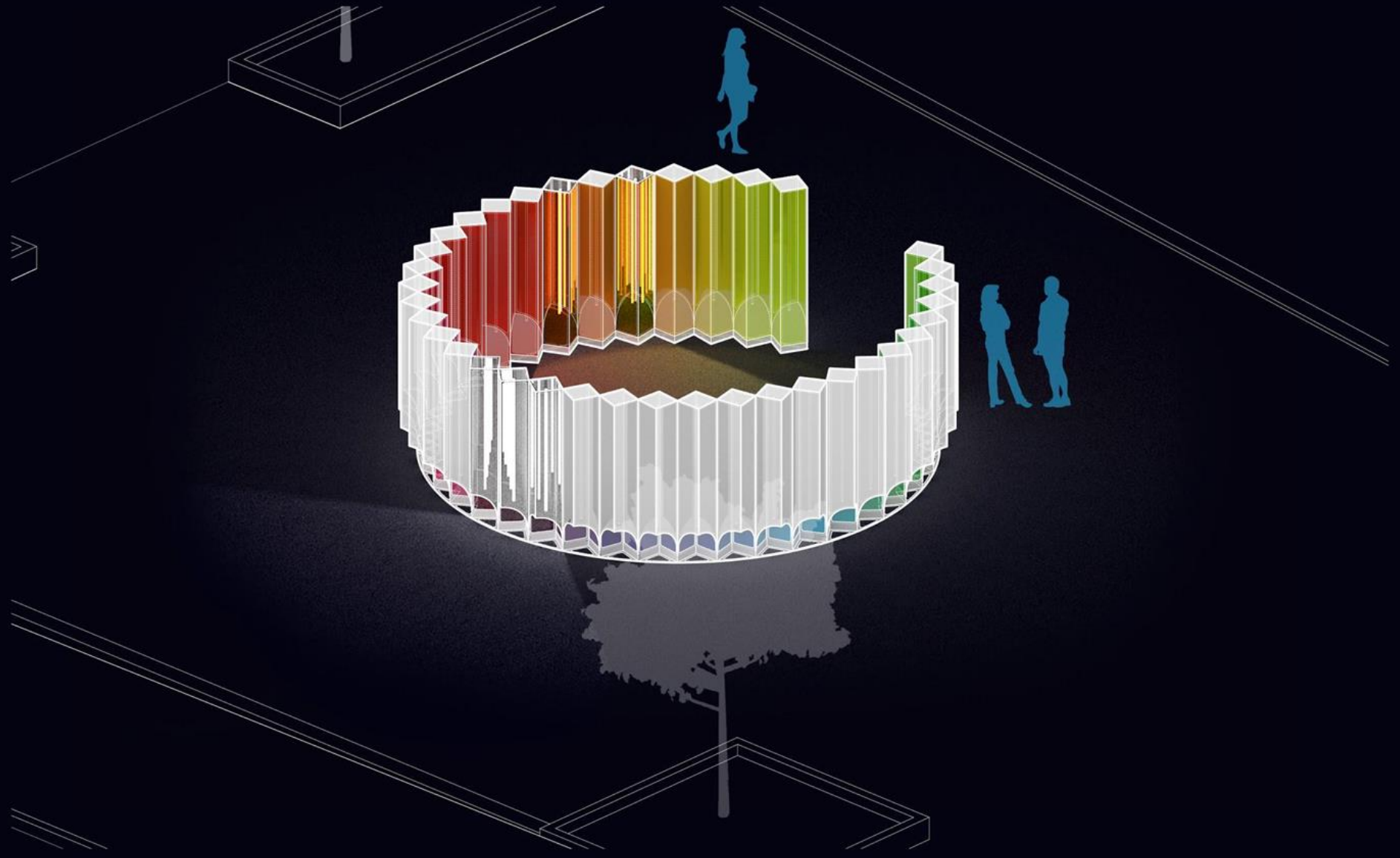

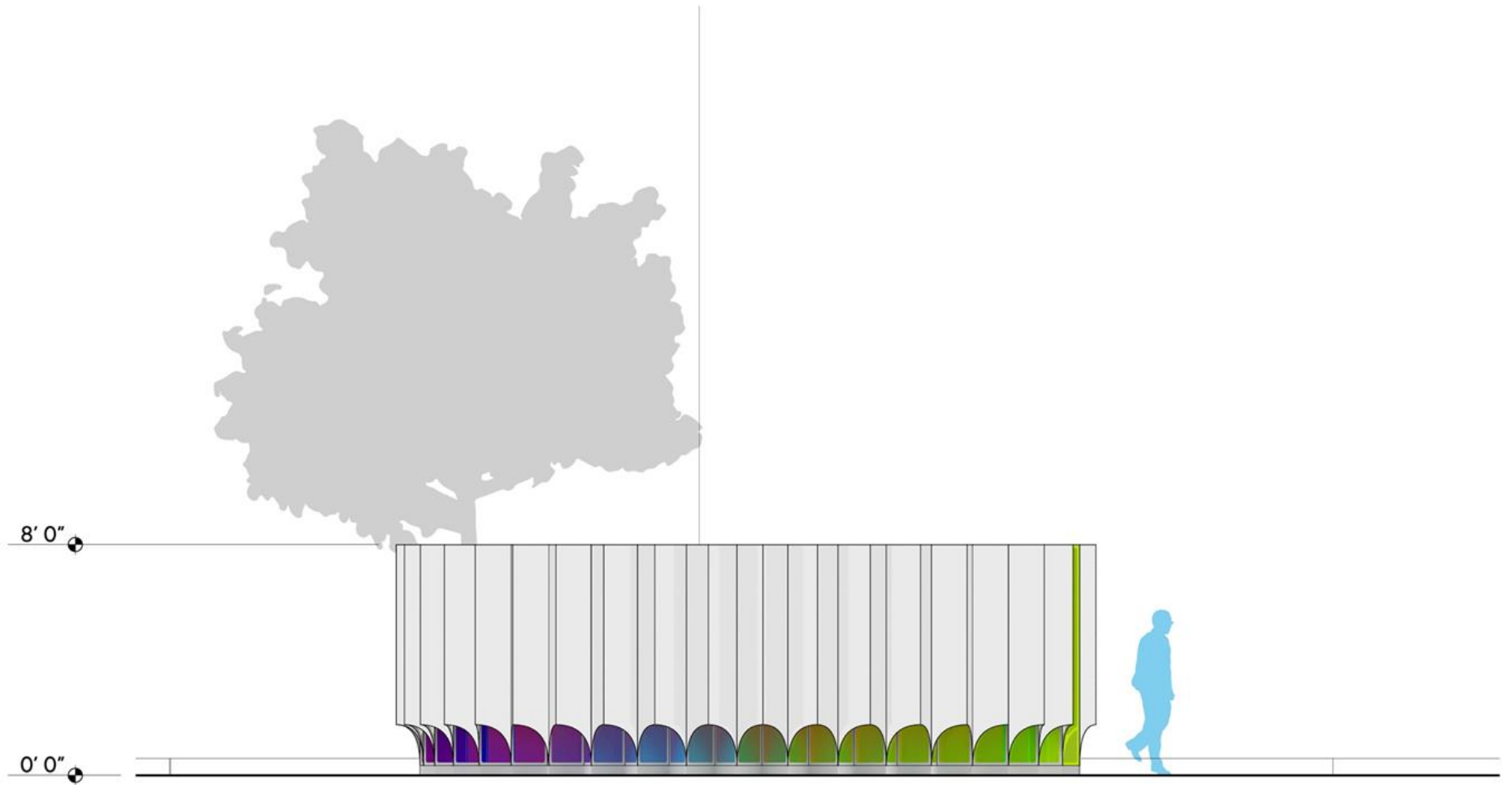



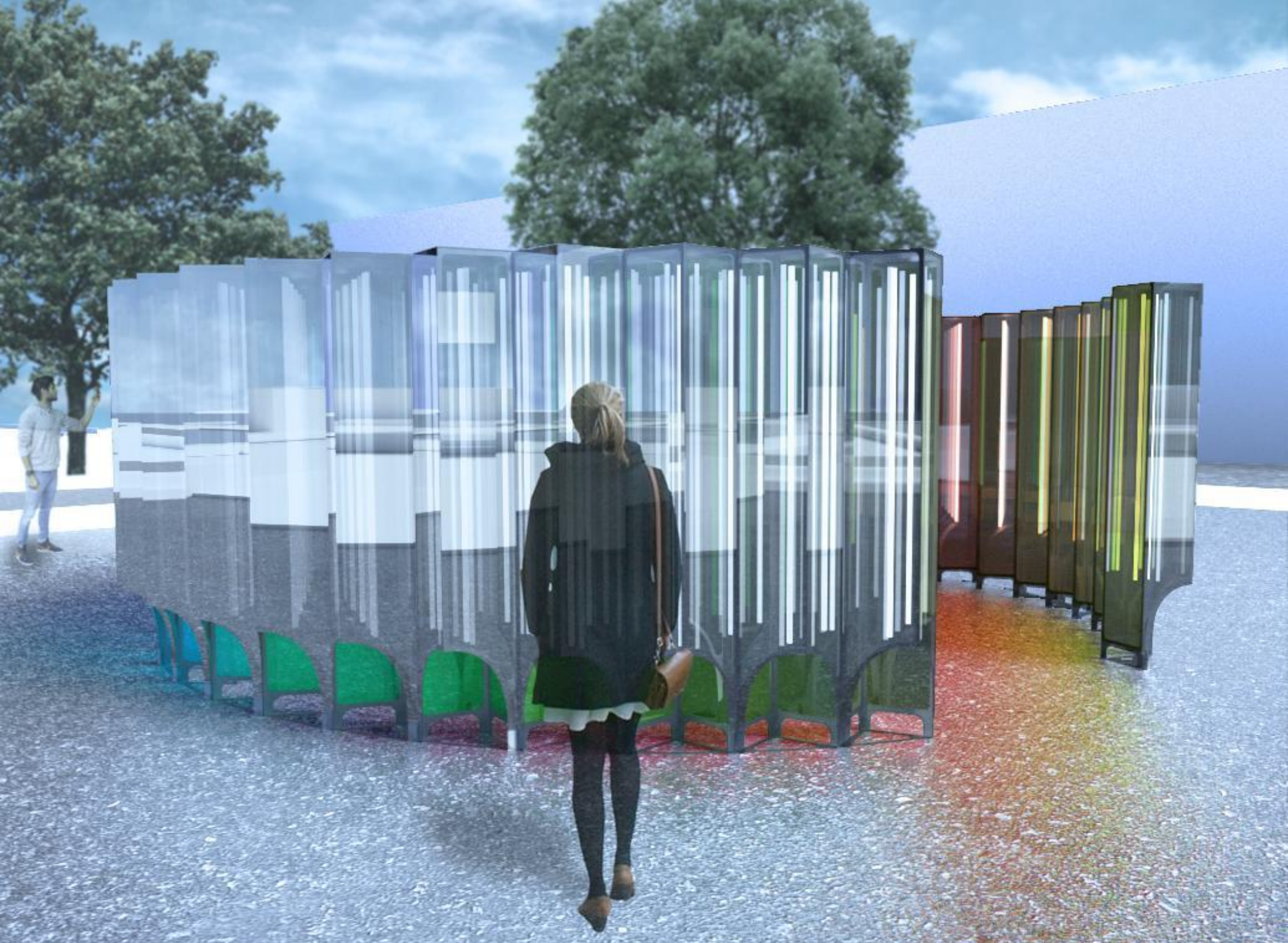

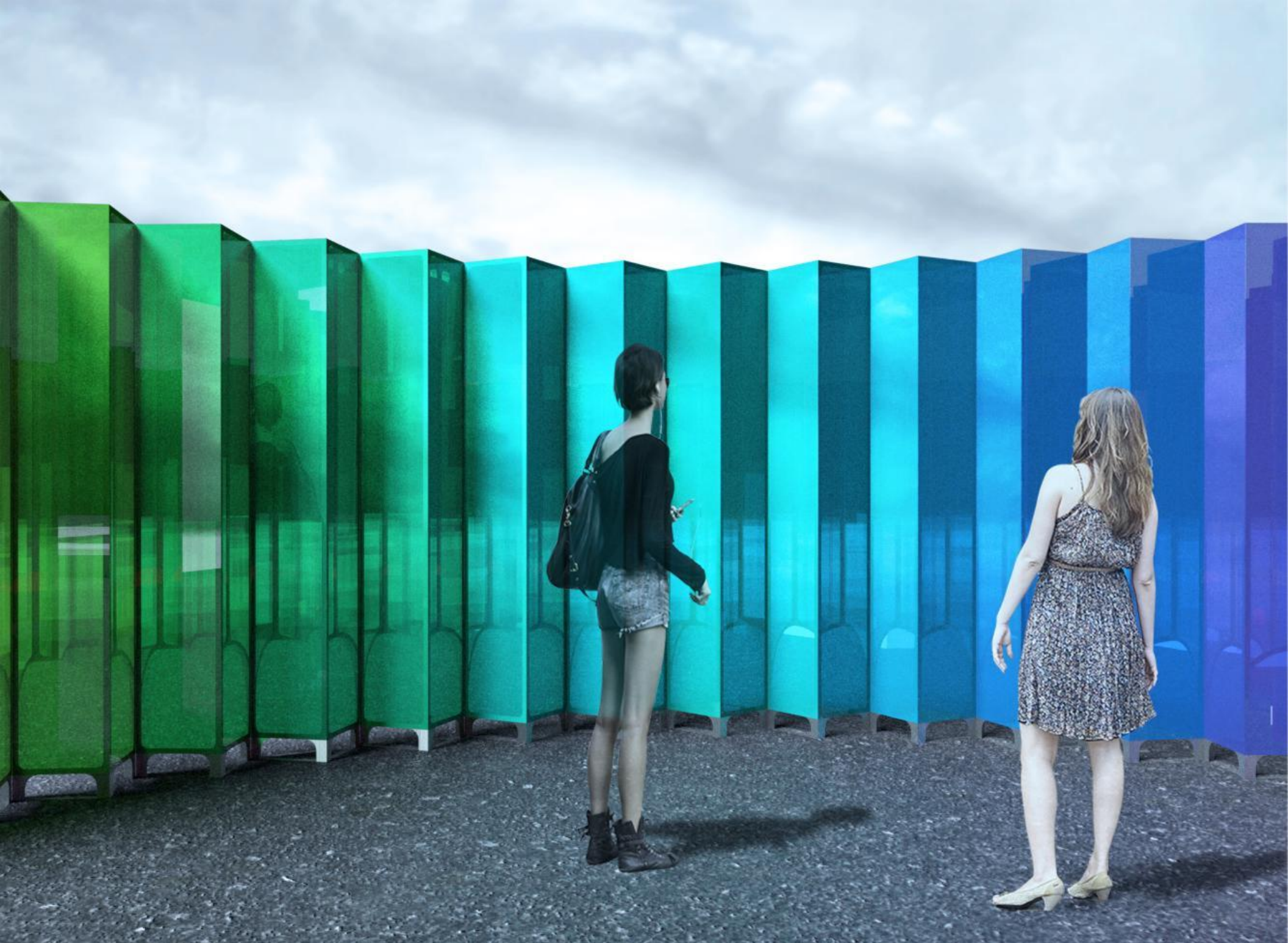





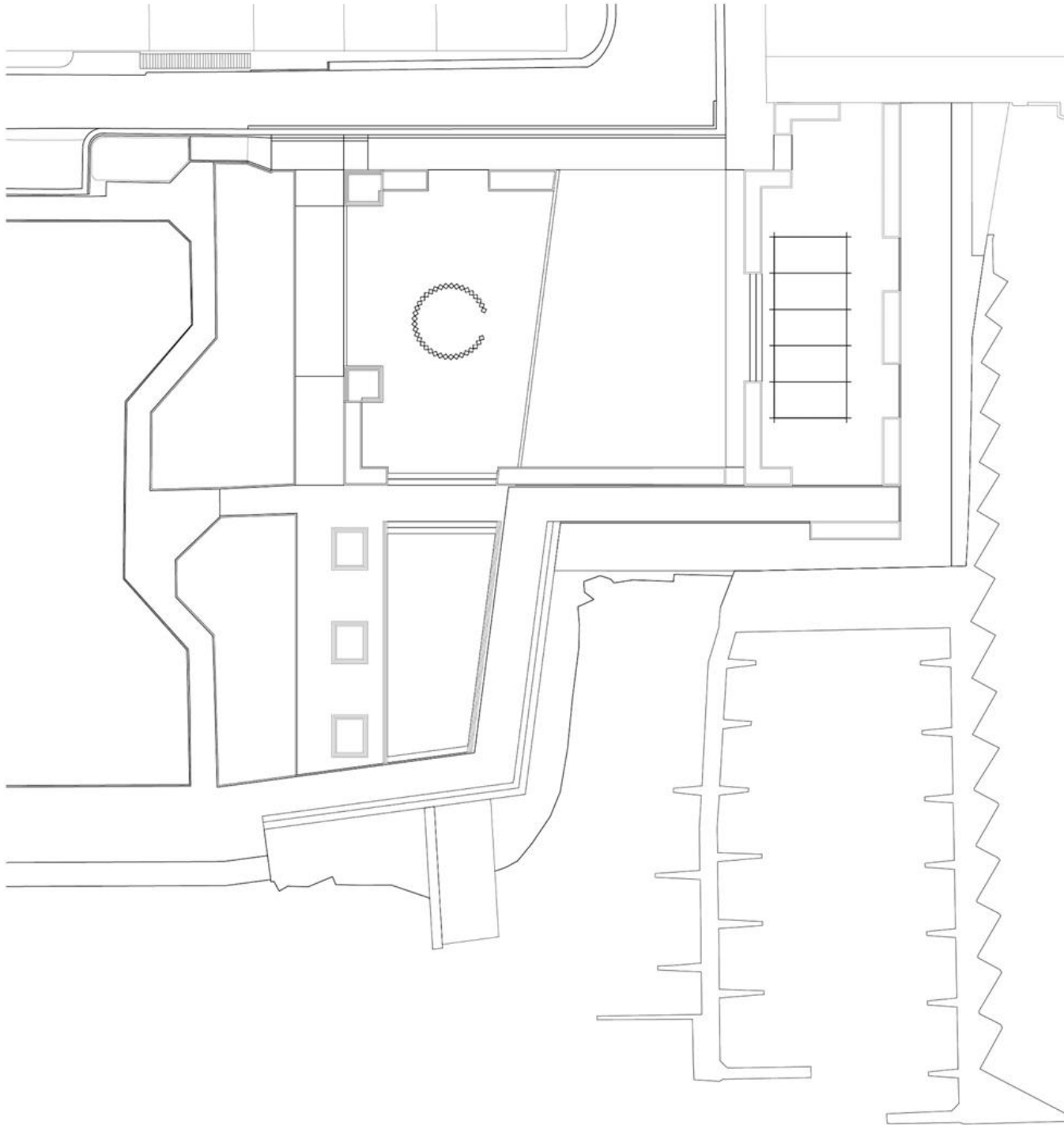

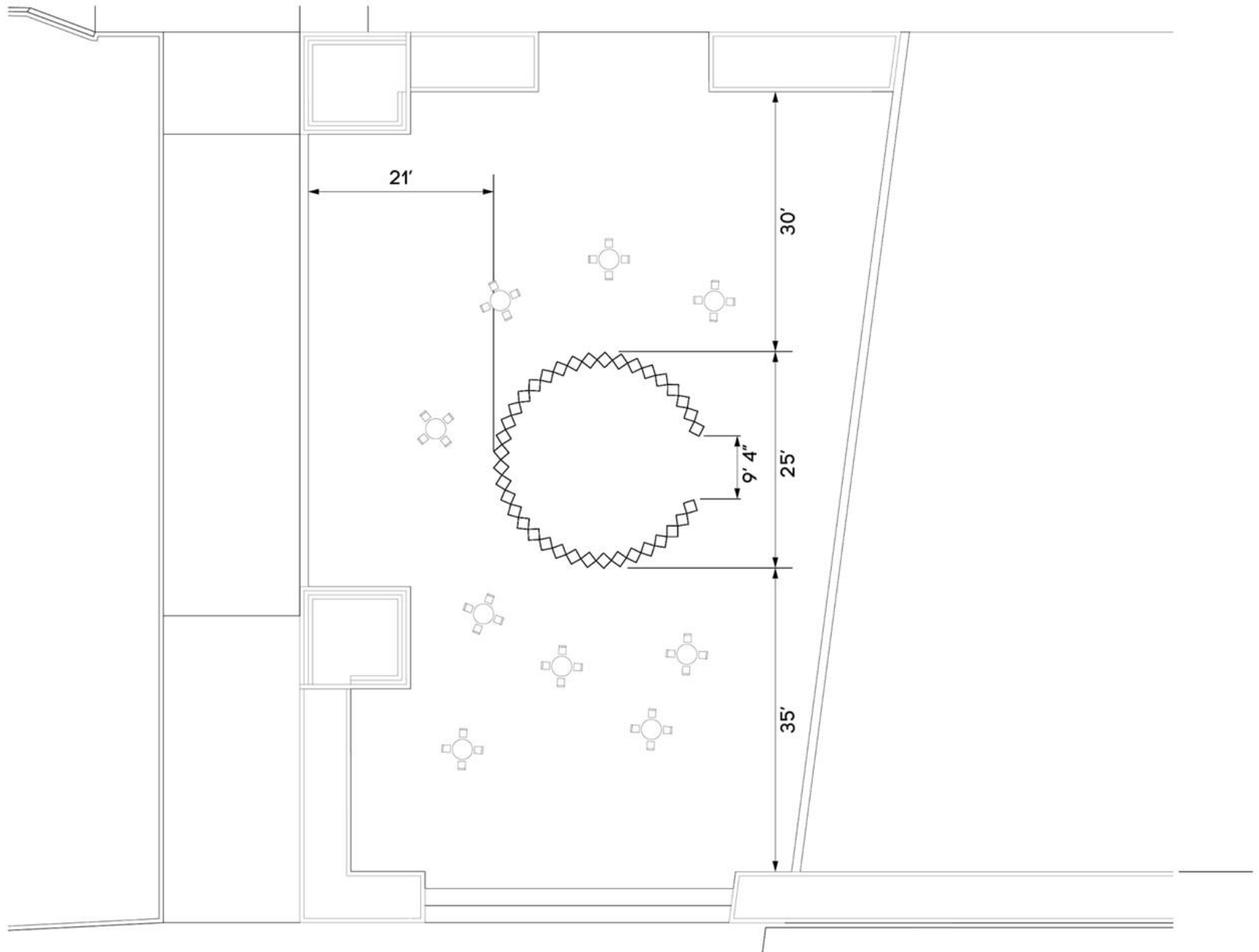

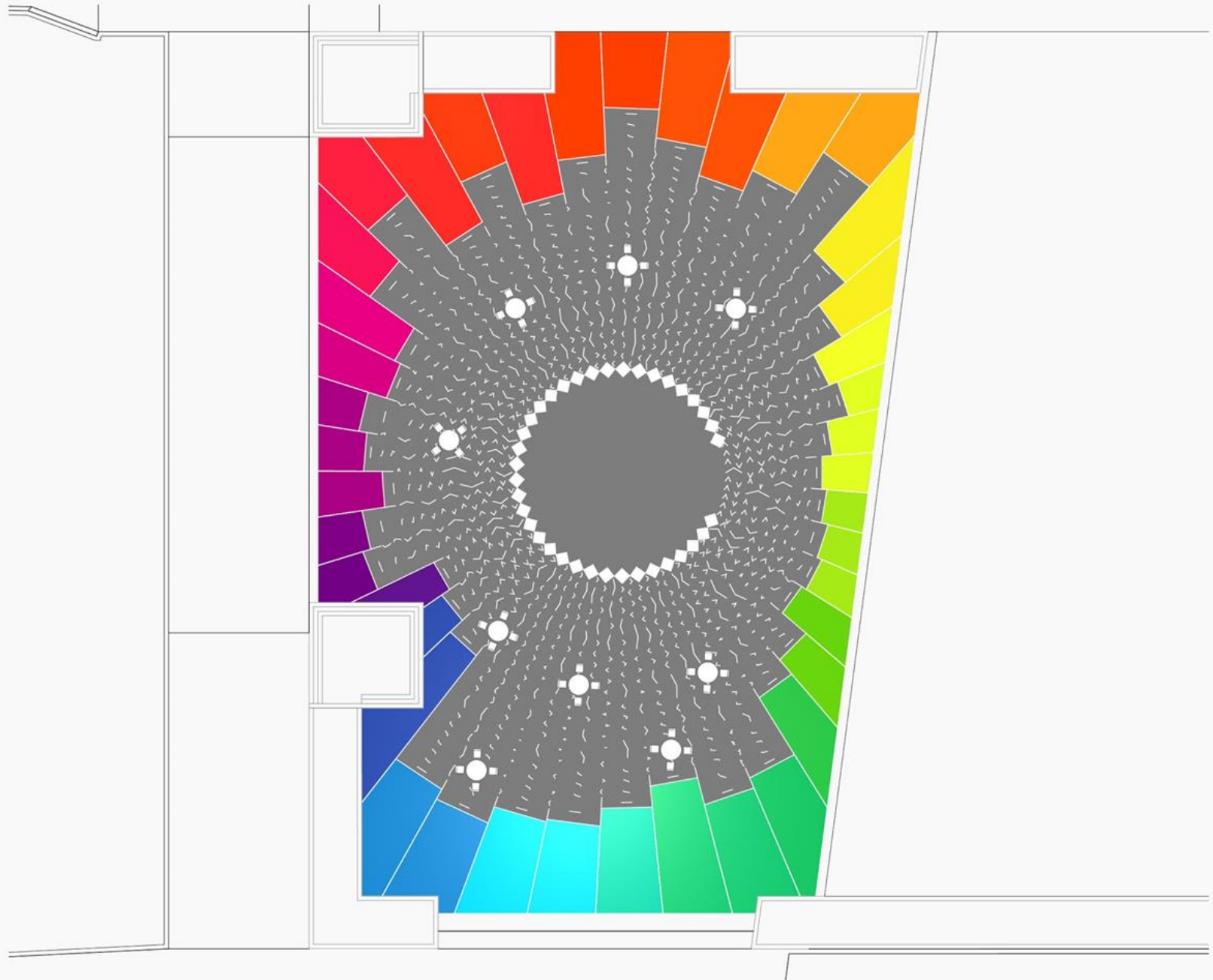



900 RADIUS

36 UNITS

45 SPIKE

300 HGHT

8 DIE_RATE

VIEW_MIRRORS

PERS

RESETVIEW

0.10 POLAR_SPEED

2.00 WAVE_SPEED

20.00 SW_AMPLIFY

0.80 RANDOM_THRESHOLD

10.00 PULSE_SPEED

200.00 AMPLITUDE

100.00 THRESHOLD

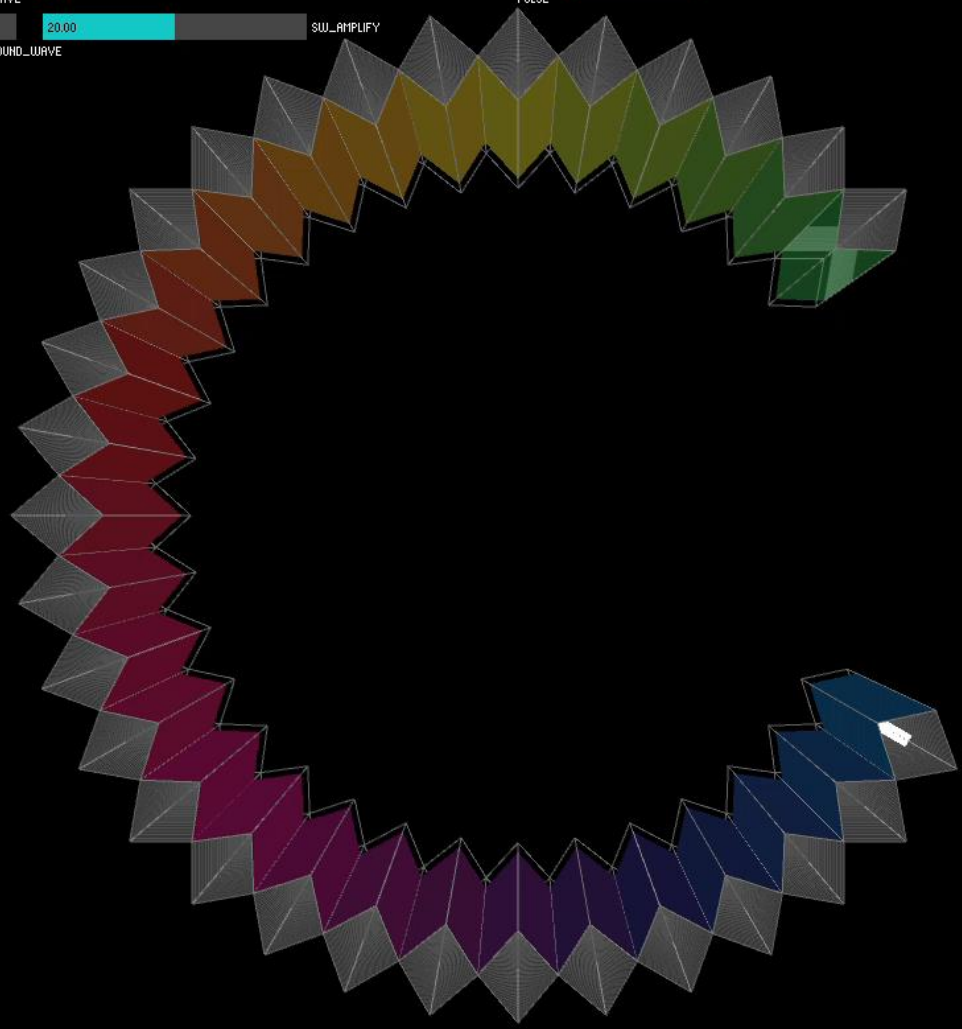

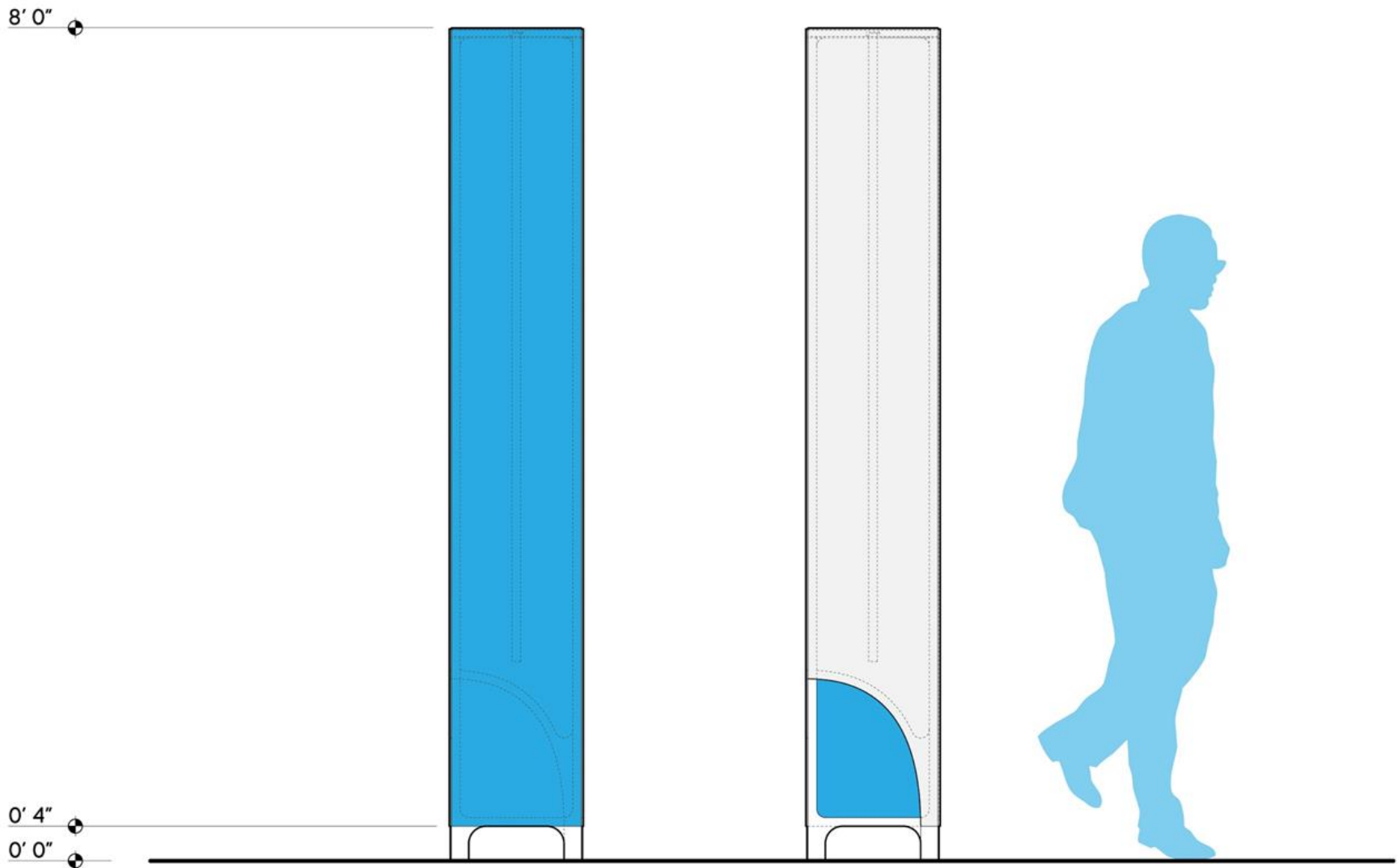

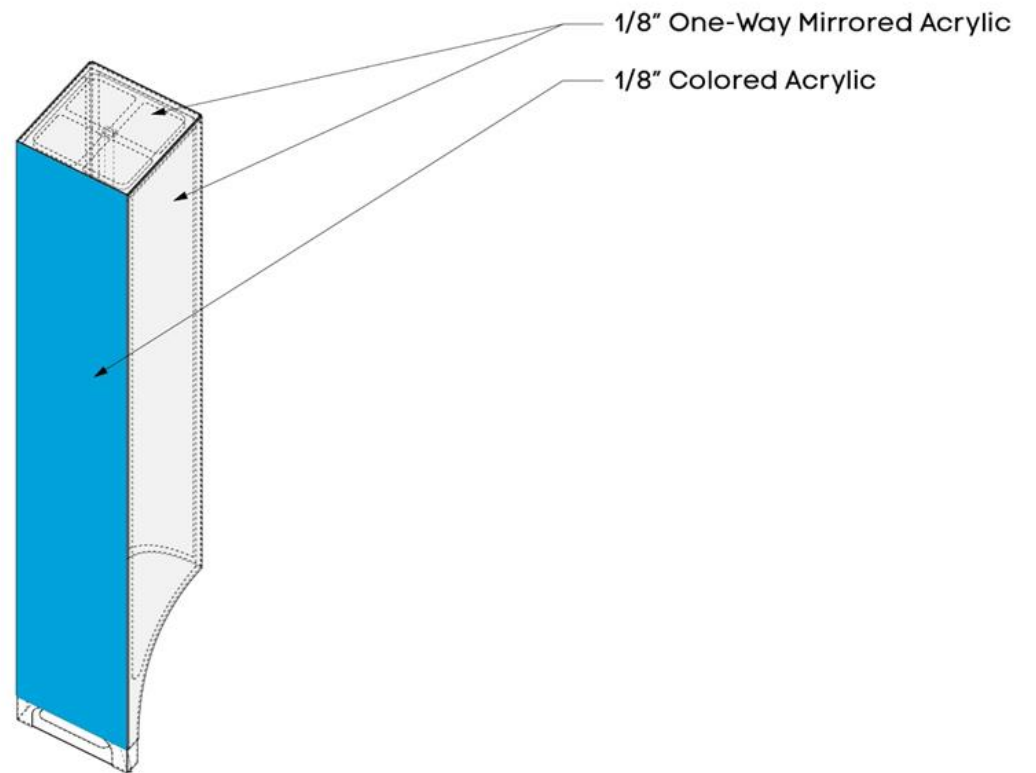

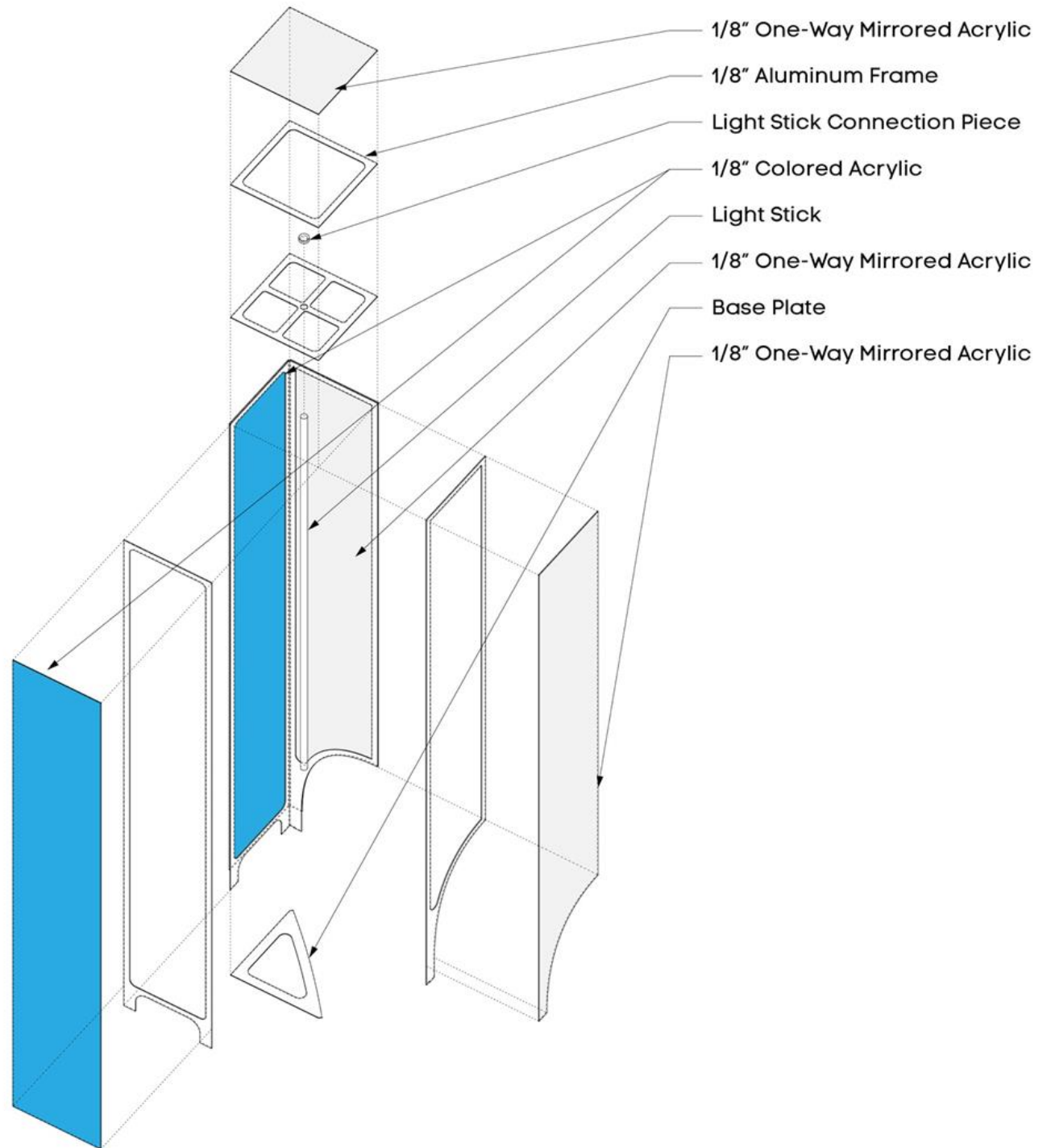

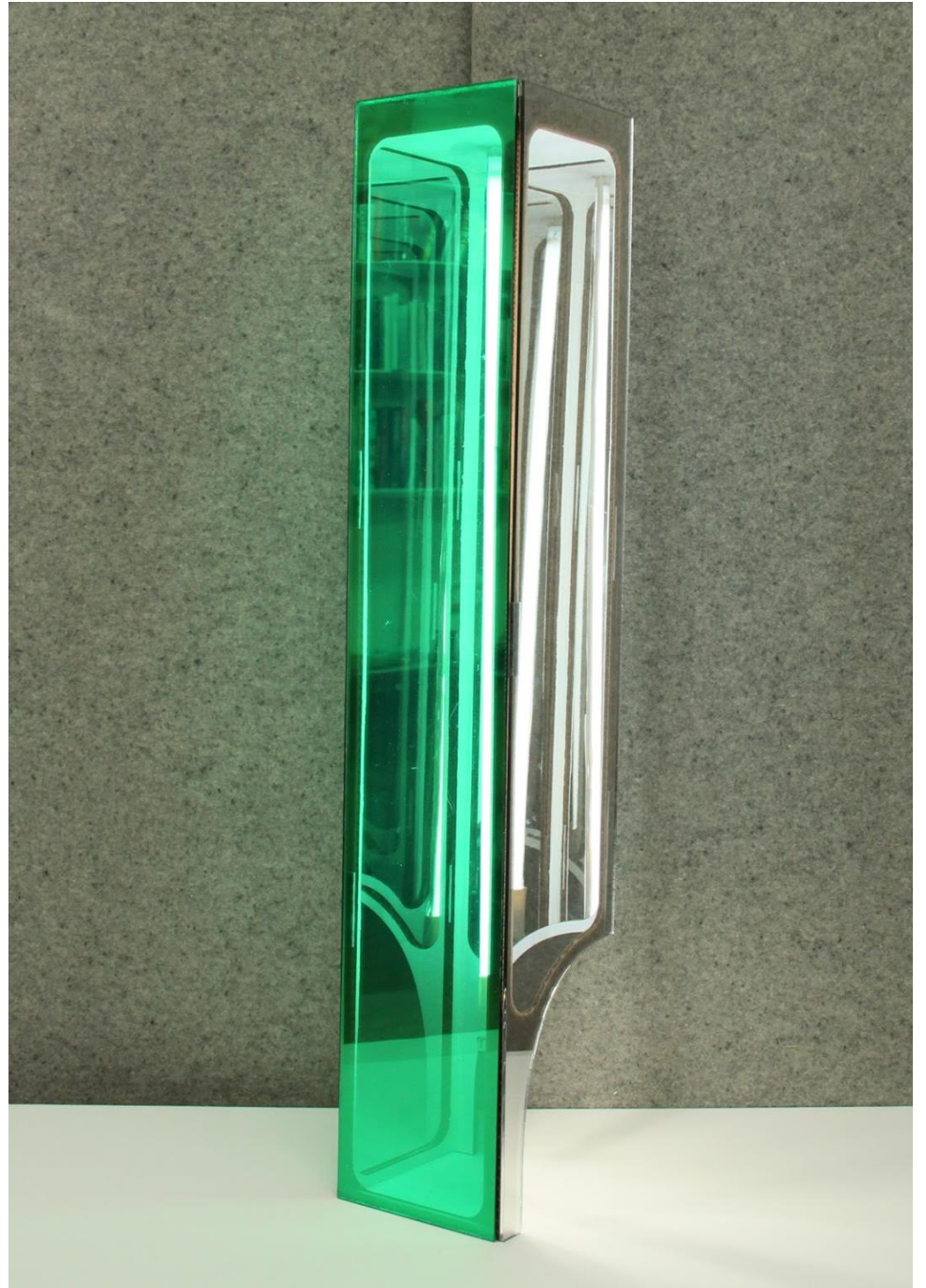

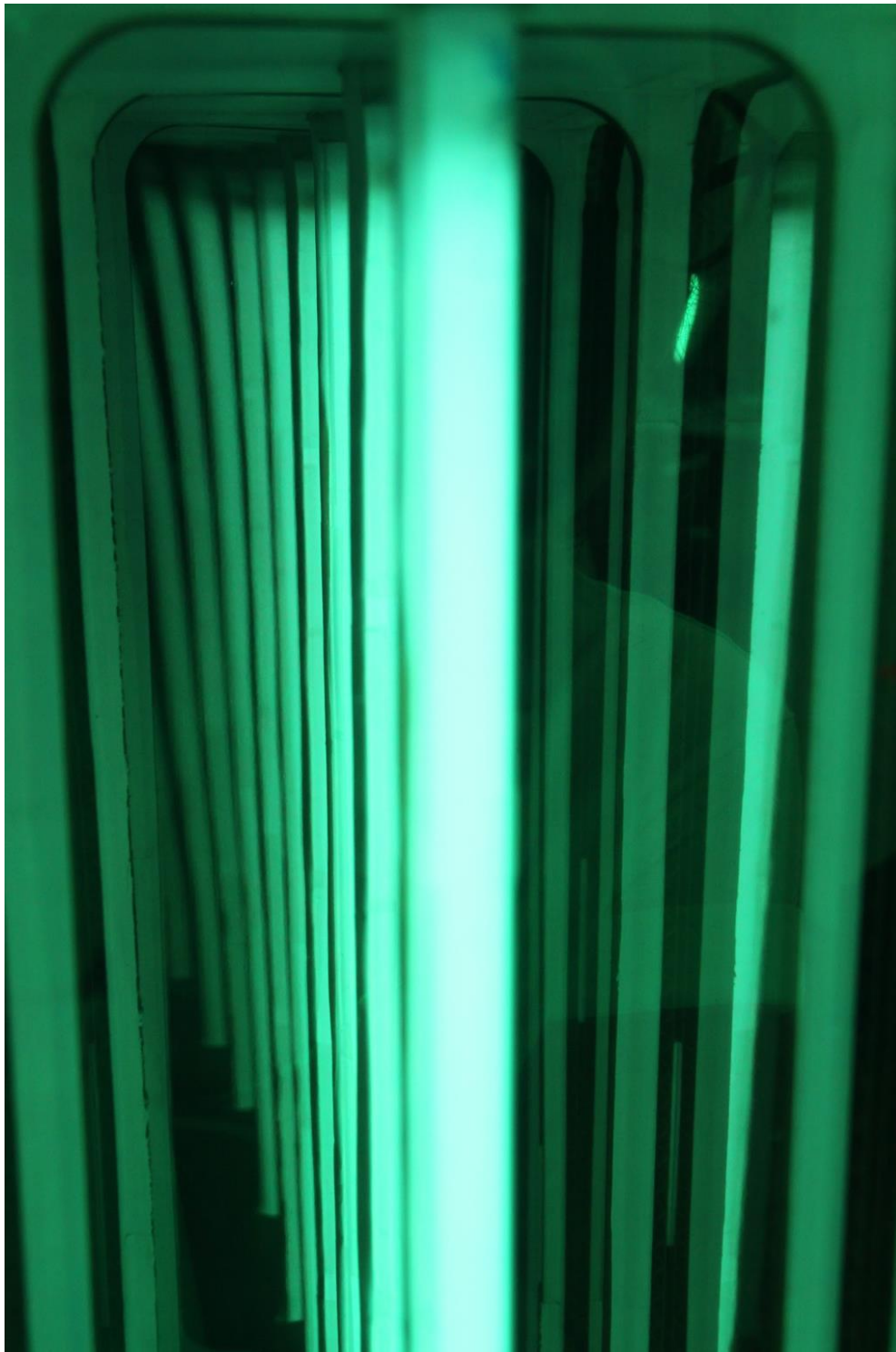

Motion made by:	Motion seconded by:	Vote count
Catherine Barrett	Alison Heek	Yes— 13 No— 0 Abstained— 0

ACA Motion

Agenda Item #: VII. 2
 Motion:

Motion to approve SOFTlab's Public Art
 Concept Proposal for the yet-to-be-named
 King Street Waterfront Park.

Discussion notes:
 (continue on other side of page if necessary)

ALEXRENEW PUBLIC ART RESIDENCY

PROJECT PLAN FOR FIRST RESIDENCY

October 11, 2018

DRAFT

Table of Contents

I. Introduction	3
II. Background and Context.....	3
RiverRenew Background	3
Artist Residency Program Context	4
III. Public Art Residency Format, Goals and Outputs	4
Format.....	4
AlexRenew Public Art Residency Goals.....	4
2019 – 2020 Public Art Residency: Artist’s Project Goals	5
2019 – 2020 Possible Outputs	5
IV. Selection Process	5
AlexRenew Public Art Residency Task Force.....	5
Artist Selection Process.....	6
Qualifications Phase.....	6
Finalists’ Site Visit.....	6
Finalists’ Presentations and Interviews	6
Final Selection	6
V. Project Development Process and Approval	7
Location Considerations.....	7
VI. Timeline	7
VI. Budget.....	8
VII. Community Engagement, Marketing and Communications	8
Stakeholders	8
Marketing and Communications.....	8
VIII. Evaluation	8

I. Introduction

The City of Alexandria's Public Art Implementation Plan, adopted in 2014, outlined a vision and goals for the public art program and established three Creative Directions for its work: Time and Place, Neighborhood and Gathering Places, and Natural and Urban Systems.

The Plan also sets out a process for the commissioning of new public art. For each project approved in the Annual Public Art Work Plan, the Commission for the Arts appoints a Public Art Project Task Force to advise on the entire project development process. The staff and the Project Task Force develop a Project Plan that sets out the project goals, artist selection process, budget, timeline, and communications strategy. The Project Task Force then selects an artist, through a process set out in the Project Plan. The artist develops a concept, which is then approved by the Project Task Force and the Commission for the Arts.

The Office of the Arts engaged Meridith McKinley and Aliza Schiff of Via Partnership, working with Todd W. Bressi, to develop an overall strategy for the residency in collaboration with AlexRenew. With the appointment of the *AlexRenew Public Art Residency* Task Force, they facilitated the development of this Project Plan for the approval of the Commission for the Arts.

This Project Plan is for the first of an anticipated three artist residencies with AlexRenew during a seven-year period.

II. Background and Context

The Natural and Urban Systems creative direction described in the Public Art Implementation Plan calls for public art that adds to the civic discussion about building a sustainable, healthy and diverse city and creates a sense of connection throughout various areas of the city.

As a river city, one of Alexandria's defining features is its waterways, both natural and human-made. Currently, Alexandria Renew Enterprises (AlexRenew, a special-purpose authority that treats wastewater for the City of Alexandria and parts of Fairfax County) is embarking on a major capital program called RiverRenew to invest in a system of tunnels that will improve the health of Alexandria's waterways. In recognition of this major upcoming capital project, and other capital projects that will increase the AlexRenew treatment plant's capacity, the Public Art Annual Workplan Task Force for FY16-18 recommended collaborating with AlexRenew to create a public art residency in collaboration with the agency.

A public art residency offers an innovative way to involve artists over an extended period of time in the ongoing community conversation about the importance of cleaner, healthier waterways. It can result in both temporary and permanent public artworks in multiple locations that connect the community to the important work being done to improve and maintain the health and sustainability of Alexandria's waterways.

RiverRenew Background

Older parts of Alexandria are served by a combined sewer system, constructed in the late 1800s, that collects both rainwater and sewage in the same pipe and transports to it AlexRenew's water resource recovery facility for treatment. During rainstorms, too much rainwater can overwhelm the system, causing excess combined rainwater and sewage to flow into Alexandria's waterways at four outfalls,

carrying pollutants into local rivers and streams without being treated. RiverRenew is a seven-year program owned and implemented by AlexRenew, with support from the City of Alexandria, to remediate these four outfalls by capturing and treating the combined rainwater and sewage before it overflows into Alexandria's waterways. It is in response to a 2017 Virginia law to achieve healthier, cleaner waterways in Alexandria by 2025.

This major investment in the health of Alexandria's waterways provides a unique opportunity for the Office of the Arts' Public Art Program to collaborate with AlexRenew on a public art residency for the duration of the seven-year RiverRenew program.

Artist Residency Program Context

Many cities in the U.S. and Canada, including Austin, Boston, Calgary, Houston, Los Angeles, Minneapolis, New York City, St. Paul and Vancouver, have been embedding artists in residence in city government agencies. These programs have varying goals. Some endeavor to integrate artistic practices into government work, while others ask artists to provide innovative solutions to problems or to engage residents in creative ways with the agency's work. Some are designed simply to allow an artist access into city systems and time to create work based on that experience.

Artist residencies in public agencies allow artists to have a longer-term engagement with a topic, agency, or system than would otherwise be possible, as they usually involve an extended period of immersion, research, and interaction with staff and community before the artist proposes a project or begins to develop a work of art. This immersion period can include organized tours, job shadowing, attending agency meetings and other activities designed to help the artist gain connections within the agency and understand its work. An ongoing artist residency program also has the potential to have a greater impact than a one-off project. Multiple projects by various artists can have a cumulative effect, and agency and arts program staff can learn from the process and apply what they have learned to the next iteration of the program.

III. Public Art Residency Format, Goals and Outputs

Format

This is a seven-year initiative to parallel RiverRenew. Three separate residencies are anticipated during that timeframe, with the artists' projects staggered to occur approximately every other year. Each artist would be engaged for about 18 months, including an initial period of immersion, followed by proposing a project and time to implement the project.

AlexRenew Public Art Residency Goals

Each of the three residencies may take on its own focus, but all will be guided by the following overarching goals:

- Create opportunities for artists to engage deeply over an extended period of time with AlexRenew, the RiverRenew program, Alexandria's waterways and the Alexandria community through a process that includes significant research and community engagement.
- Allow the Office of the Arts and AlexRenew to develop a collaborative relationship that serves the larger goals of each agency.

- Result in multiple temporary or permanent public artworks, in locations throughout Alexandria that have strong community engagement components and connect the community to broad issues of water stewardship.

2019 – 2020 Public Art Residency: Artist’s Project Goals

The artist selected for the initial residency will be asked to consider the following goals as they develop their work:

- Enable local residents to explore, understand and internalize their own relationship to water and the health of waterways.
- Increase local residents’ personal commitments to water stewardship and understanding of the ways they can contribute to improving and maintaining the health of Alexandria’s waterways.
- Increase residents’ understanding of the natural and infrastructural water systems that support the functioning and health of the city.

2019 – 2020 Possible Outputs

The first residency will result in a temporary or permanent public art project. The project must have a strong community engagement component, including a clear plan for how the community will participate and be engaged in the development of the work and/or the project itself. The project must have a physical presence in a location(s) in Alexandria and must be available to the public to interact with and experience for a significant period of time (i.e. the project cannot be a one-time performance or a website).

IV. Selection Process

For the first artist residency, the Office of the Arts has engaged Meridith McKinley and Aliza Schiff of the consulting firm Via Partnership, working with Todd W. Bressi, to facilitate artist selection and manage the overall project.

AlexRenew Public Art Residency Task Force

The *AlexRenew Public Art Residency* Task Force helps shape the Project Plan for the residency and recommends selection of artist(s) and approval of concept(s). The Task Force is composed of:

Two Commission for the Arts representatives:

- Beth Coast
- Chris Kurowski

Two AlexRenew Staff Members:

- Lisa Van Riper, Director, Enterprise Communications
- Caitlin Feehan, RiverRenew Program Manager

Additional member of the community at-large:

- Matthew Clark, Landscape Architect, LandDesign

Artist Selection Process

An open call to artists would be used to select the artist for the *AlexRenew Public Art Residency*. An RFQ would be developed and distributed widely, gaining attention for the program nationally and alerting artists to the opportunity. At the same time, a targeted list of artists whose practice involves a strong community engagement component and engages with water or other environmental issues would be developed. The RFQ would be sent directly to these artists.

Depending on the pool of applicants, it could be possible to select two or more of the artists from the same RFQ and to then stagger their work across two or all three residencies.

Qualifications Phase

Based upon the approved Project Plan, the Office of the Arts, working with its project consultants, will draft an RFQ. Interested artists would be asked to submit:

- a letter stating their interest in the residency and describing their basic approach to the residency,
- a resume,
- up to 10 images of past work, and
- the names and contact information for three professional references.

If there are a very large number of applications, staff and consultants may do a preliminary review and eliminate any unqualified applicants prior to presenting the submissions to the Task Force.

The Task Force will review submissions and select 3 to 5 finalists. Finalists will be paid a stipend for their participation in a site visit and interview.

Finalists' Site Visit

The selected finalists will be invited to Alexandria for a site visit, ideally as a group. The site visit will include a tour of AlexRenew's facilities and other relevant sites in Alexandria and time with AlexRenew and Office of the Arts staff and the Task Force. This will be a chance for the finalists to begin to get to know the people and topics they would be engaging with, ask questions, and begin to formulate their approach to the residency, and for staff to begin to get a sense of what it would be like to work with each artist.

Finalists' Presentations and Interviews

About two weeks after the site visit, each finalist will be scheduled to make a presentation to the Task Force via video conference. Each finalist's presentation will include their reactions to the site visit and their responses to a list of questions they will have been given during or immediately after the site visit.

The presentation will also include time for the Task Force to ask any follow-up questions of each artist.

Final Selection

The Task Force will make their final selection based on the presentations and interviews and may select more than one artist and then stagger their work. The selected artist(s) will be approved by the Commission for the Arts.

V. Project Development Process and Approval

The artist selected for the first residency will take part in a period of immersion with the community and in the work of AlexRenew and the RiverRenew program before proposing a temporary or permanent public art installation. The initial immersion period will last about a week, during which time the artist will be present in Alexandria and will take part in activities planned by the Office of the Arts and AlexRenew, such as tours and meetings, as well as more open-ended time spent with AlexRenew staff and the community. It will be followed by a period of about eight weeks of additional artist-designed research, interaction with the community (including an artist talk) and idea generation. This may involve additional trips to Alexandria and time “on site” or “in the field” to execute research and interact with the community, depending on the artist’s working process. The artist will be paid a fee for this immersion and idea generation period.

Shortly after the immersion week and before beginning further work, the artist will make an initial presentation to the Task Force outlining their plan for further research and engagement and the areas they intend to explore, including a timeline for project development. About eight to twelve weeks later, the artist will return to the Task Force with a full Project Proposal that includes a rendering, narrative description, proposed location(s), fabrication or implementation methods, a timeline, community engagement plan and budget. The Project Proposal will be reviewed for feedback by the Task Force. The Project Proposal will be approved by Commission for the Arts prior to execution.

Location Considerations

The project must have a physical presence in a publicly owned property for a significant period of time. The project location will be chosen by the artist, based on their research and community interactions and in consultation with AlexRenew and Office of the Arts staff.

Consideration should be given to locations that:

- have a direct physical relationship to Alexandria’s natural and human-made water systems;
- are geographically dispersed through the City;
- are publicly accessible;
- are highly visible; and
- can be accessed by pedestrians and bicyclists.

VI. Timeline

October 9, 2018	Task Force reviews and approves Project Plan.
October 16, 2018	Project Plan to Commission for the Arts for approval. Task Force members recommend artists to invite.
Late Oct./Early Nov. 2018	Issue open Call to Artists and invite artists on list to apply.
February 2019	Review qualifications and select finalists.
Feb./March 2019	Site Visit and Presentations/Interviews
March 2019	Task Force Selects Artist(s), Commission for the Arts Approves
May 2019	Artist Immersion Week in Alexandria

Summer 2019	Artist Research, Community Engagement, Idea Generation
September 2019	Task Force Approves Artist’s Concept Proposal, Commission for the Arts Approves
Fall 2019 – October 2020	Artist Carries out Project

VI. Budget

From Public Art Fund	
Finalist Stipends (3@\$750 per artist + up to \$400 per artist for travel)	\$ 3,500
Artist Immersion, Community Engagement and Idea Generation Period	\$ 7,500
Final Design, Fabrication, Implementation, and/or Installation (not to exceed)	\$24,000
Total	\$35,000

VII. Community Engagement, Marketing and Communications

An overarching community engagement, marketing and communications strategy should be developed for the overall AlexRenew Public Art Residency that aligns with AlexRenew’s community engagement, marketing and communications strategies. The selected artist would also develop community engagement strategies specific to their process and project. The artists’ general approach to community engagement and its role in their past projects should be a factor considered during the artist selection process and should be addressed in detail in each selected artist’s project proposal.

Stakeholders

Community engagement, marketing and communications should be focused on an effort to engage the entire community and not just one segment of Alexandria and to illustrate how we are all connected by water. Efforts can build on RiverRenew’s outreach processes and begin with stakeholders being identified through those channels.

Marketing and Communications

An overarching marketing and communications approach should be developed for the overall AlexRenew Public Art Residency initiative. This should align with the RiverRenew program’s marketing.

The Office of the Arts and AlexRenew staff will develop a marketing and communications strategy for the first residency that will include:

- Web-based information about the residency program, the selected artist and their project.
- Social media announcements about specific events.
- Print materials about the residency to be distributed at appropriate events and venues.
- Media releases to local and national publications and blogs.
- Print and/or online advertising in local and regional publications.
- Micro-targeted online / social media advertising.

VIII. Evaluation

The Office of the Arts and AlexRenew should establish an evaluation protocol and methodology with the goals of evaluating both 1) the external success of the artist’s project and the community’s interaction

with it, and 2) the internal success of the interagency collaboration and the working methods of the residency model. The evaluation should be ongoing and process-oriented to help the Office of the Arts and AlexRenew troubleshoot and tweak as they work toward commissioning the second and third artist residencies in the program. The artist should also be involved in developing the evaluation, based on the nature of his or her project.

Topics to be considered in an evaluation may include:

External Evaluation

- Audience demographics.
- Social media reach.
- How did visitors/participants learn about the project?
- What is their impression of the installation?
- How did the project impact their relationship with water and water stewardship?
- What was their previous awareness of Alexandria's public art program and of AlexRenew's work?
- Would they like to follow the public art program?
- Would they attend future public art projects related to this topic?
- Would they attend future public art projects elsewhere in the city?

Internal Evaluation

- Gather feedback from artist at multiple points during the residency.
- Gather feedback from participating AlexRenew and Office of the Arts staff at multiple points during the residency.
- Ongoing journal/log created by artist with reflections about process.
- Pre-established regular check-in/ evaluation points for staff and artist.

Given the resources available, we recommend contacting Virginia Tech architecture and planning faculty for assistance in developing and implementing the external evaluation.

City of Alexandria, Virginia

MEMORANDUM

DATE: OCTOBER 12, 2018

TO: ALEXANDRIA COMMISSION FOR THE ARTS

FROM: DIANE RUGGIERO, DEPUTY DIRECTOR, RECREATION, PARKS & CULTURAL ACTIVITIES, OFFICE OF THE ARTS

RE: PUBLIC ART RESIDENCY PROJECT PLAN

Background:

Alexandria's Public Art Implementation Plan, adopted in 2014, outlined a vision and goals for the public art program and established three Creative Directions for its work: Time and Place, Neighborhood Identity, and Natural and Urban Systems. The Natural and Urban Systems creative direction calls for public art that adds to the civic discussion about building a sustainable, healthy and diverse city and creates a sense of connection throughout various areas of the city. As a river city, one of Alexandria's defining systems is its system of waterways, both natural and human-made. Currently, Alexandria Renew Enterprises (AlexRenew, a special-purpose authority that treats wastewater for the City of Alexandria and parts of Fairfax County) is embarking on a major capital project called RiverRenew to invest in sustainable infrastructure that will improve the health of Alexandria's waterways. In recognition of this major upcoming capital project, and other capital projects that will increase the AlexRenew treatment plant's capacity, the Public Art Annual Workplan Task Force for FY16-18 recommended collaborating with AlexRenew to create a public art residency program in collaboration with the agency.

Discussion

The artist residency will allow artists to have a longer-term engagement with a topic, agency, or system than would otherwise be possible, as they usually involve an extended period of immersion, research, and interaction with staff and community before the artist proposes a project or begins to develop a work of art. This immersion period can include organized tours, job shadowing, attending agency meetings and other activities designed to help the artist gain connections within the agency and understand its work. An ongoing artist residency program also has the potential to have a greater impact than a one-off project. Multiple projects by various artists can have a cumulative effect, and agency and arts program staff can learn from the process and apply what they have learned to the next iteration of the program.

In accordance with the Public Art Implementation Plan, the attached Program Plan outlines the format, goals, outputs, timeline, artist selection process, budget, and evaluation for the first of the three residencies. This Plan helps to provide the framework for staff and the task force to carry out the project.

With a focus on the RiverRenew initiative, the collaboration is expected to last seven (7) years with three residency programs/projects commissioned during that time. It is expected that the Project Plan will be updated and/or changed as needed with each residency.

Staff Recommendation

Staff recommends the Arts Commission approve the Project Plan for the first Public Art Residency.

Motion made by:	Motion seconded by:	Vote count
Gayle Converse	Allison Heald	Yes— 13 No— 0 Abstained—

ACA Motion

Agenda Item #:
Motion:

APPROVE PROJECT PLAN FOR FIRST PHASE OF ALEX
 RENEW PUBLIC ART RESIDENCY.

Discussion notes:
 (continue on other side of page if necessary)

City of Alexandria, Virginia

MEMORANDUM

DATE: October 16, 2018
TO: ALEXANDRIA COMMISSION FOR THE ARTS (ACA)
FROM: MATTHEW HARWOOD, PUBLIC ART MANAGER
RE: ALEXANDRIA ART PURCHASE AWARDS 2

Project Description

The City of Alexandria is purchasing original art to add to the City's art collection and to display in City-owned buildings. In this second of eight calls, the Alexandria Art Purchase Awards will procure up to \$4,100 in art.

Background

The theme of the second Alexandria Art Purchase Awards is "Natural and Urban Systems." Artists, art galleries, and art consultants working or residing in Virginia, Maryland or Washington, D.C. were encouraged to apply. Of the 180 artworks submitted, ten were chosen to go on display on the second floor at City Hall from June 15 to October 26, 2018.

Artwork Selection

The artwork selection process was juried by project task force members Allison Nance (ACA), Allison Heck (ACA), Joyce Frank (Community), Nina Carpenter (Community), and Maya Contreras (City).

The project task force met on September 19. Of the ten finalists showing in City Hall, the project task force recommended that \$4,100 in art purchase awards go to:

- Sally Veach, Woodstock, VA, for ***Cloud Five***, \$1,100
- Matthew McLaughlin, Greenbelt, MD, for ***Big Pile***, \$900
- Judith Peck, Vienna, VA, for ***Sitting in the Storm***, \$2,100

And that honorariums of \$100 go to:

- Dominie Nash, Bethesda, MD, for ***Leaf Impromptu 27***
- Donna Frostick, Henrico, VA, for ***Underneath: Willey Bridge with Canoe***
- Joyce Jewell, Takoma Park, MD, for ***Water's Edge***
- Leslie Nolan, Herndon, VA, for ***Underground 5***
- Sally Canzoneri, Washington, DC, for ***After School Snack***
- Sardar Aziz, Bryans Road, MD, for ***DC in Rain VI***
- Z Feng, Radford, VA, for ***Late Autumn***

Recommendation

Staff recommends that the Commission for the Arts votes to accept the project task force recommendations for the art purchase awards and honorariums and that staff accession the works into the City's art collection.



Motion made by:	Motion seconded by:	Vote count
Allison Hlack	Allison Nance	Yes— 12 No— 0 Abstained—

ACA Motion

Agenda Item #:
Motion:

Approve the motion on AA Purchase Awards and honorariums as provided by staff with no edits.

Discussion notes:
(continue on other side if necessary)

Motion made by:	Motion seconded by:	Vote count
Allison Heck	Susan When	Yes— 12 No— 0 Abstained— 0

ACA Motion

Agenda Item #:

Motion:

Approve fiscal year priorities as presented
in the Commission meeting

Discussion notes:

(continue on other side if necessary)