

# HOFFMAN TOWN CENTER BLOCK 2

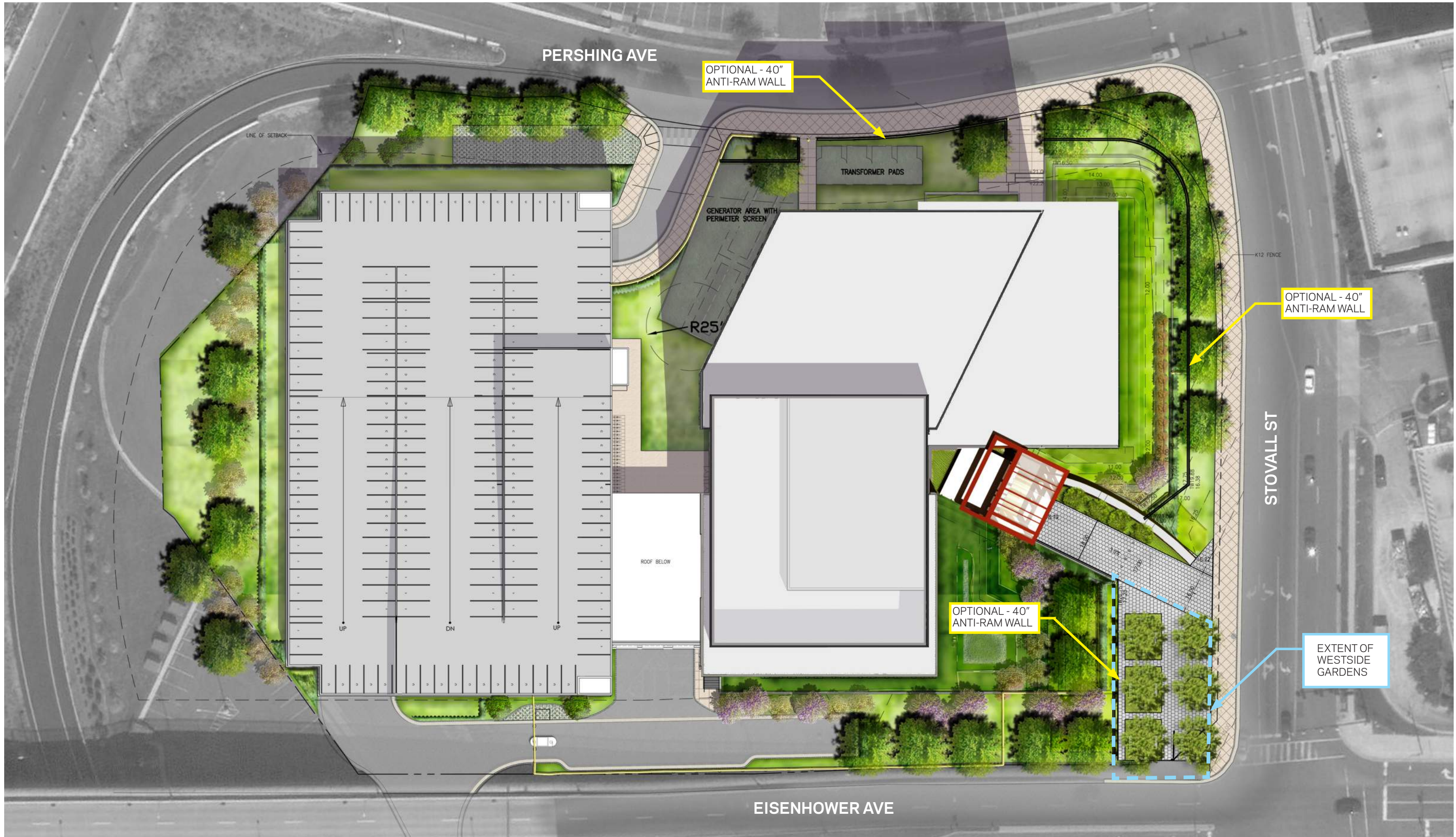

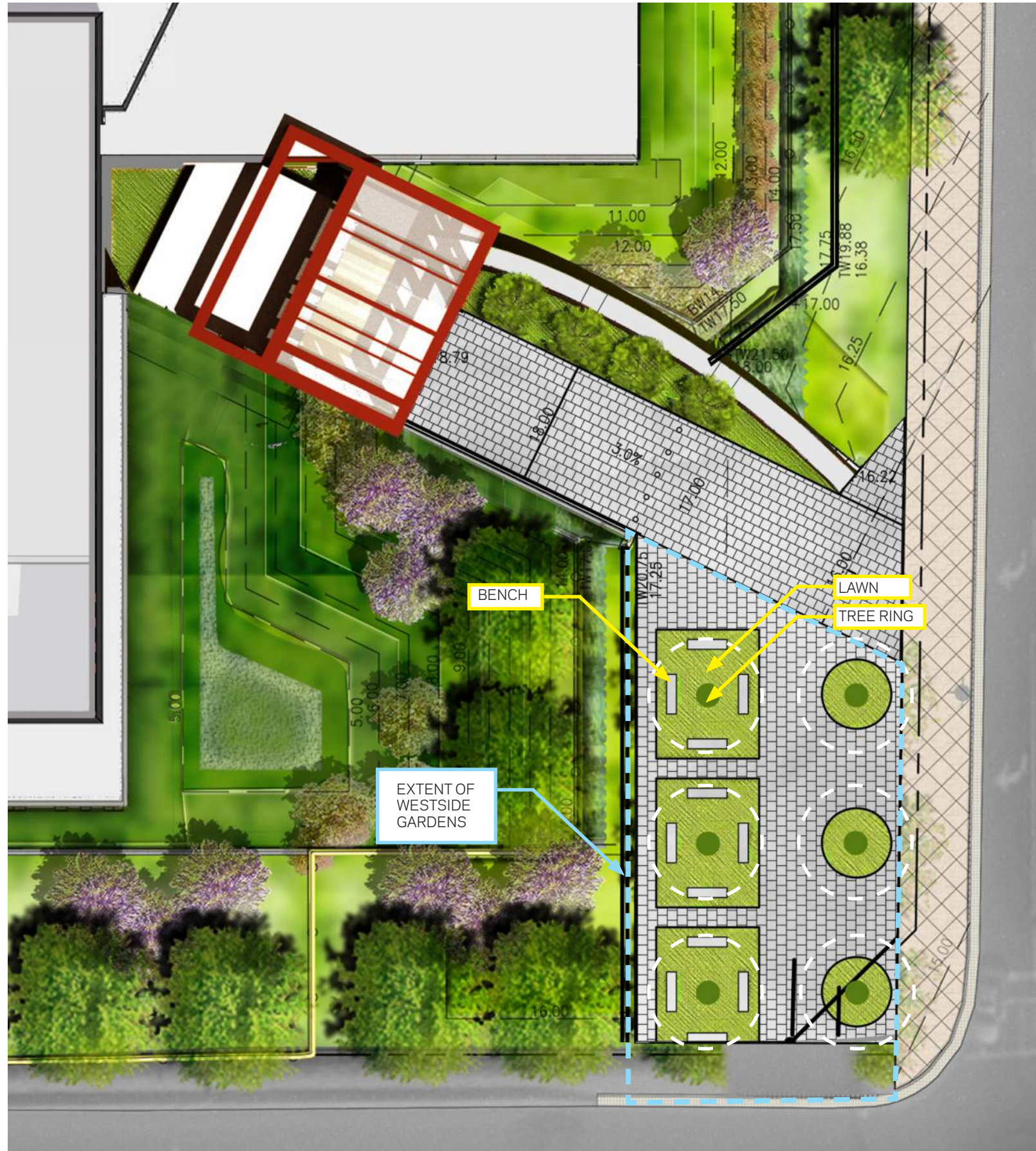

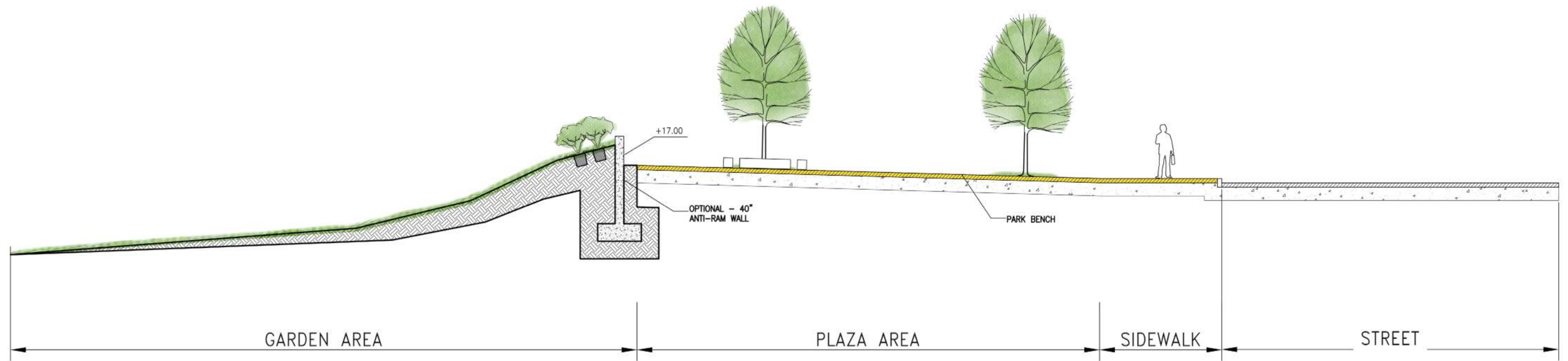

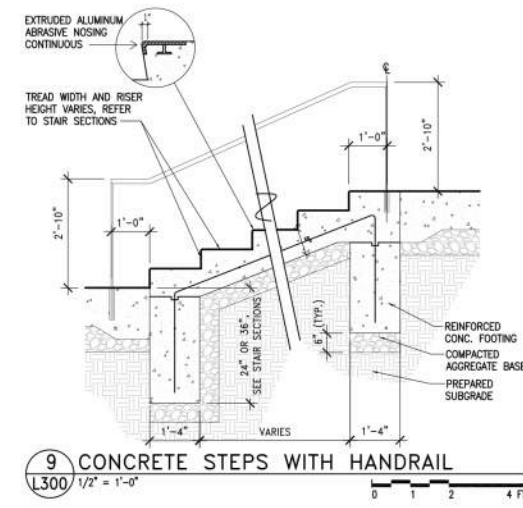
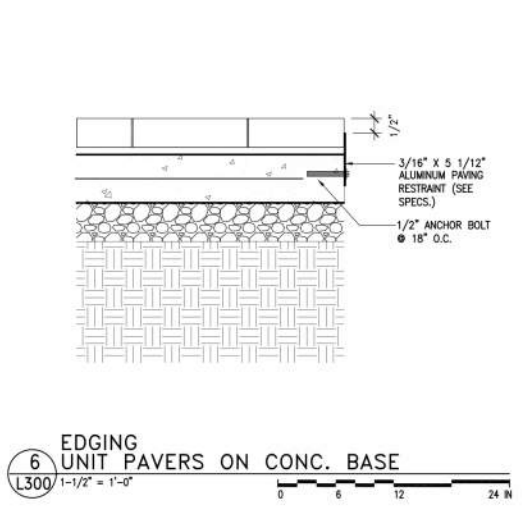
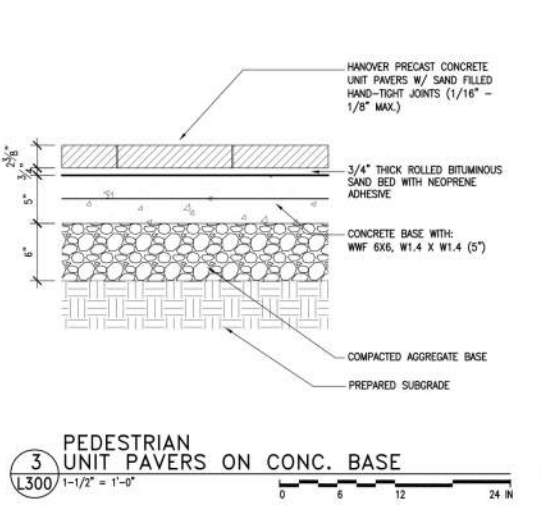
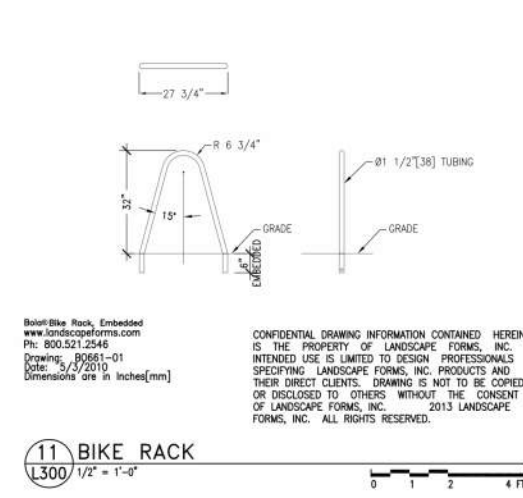
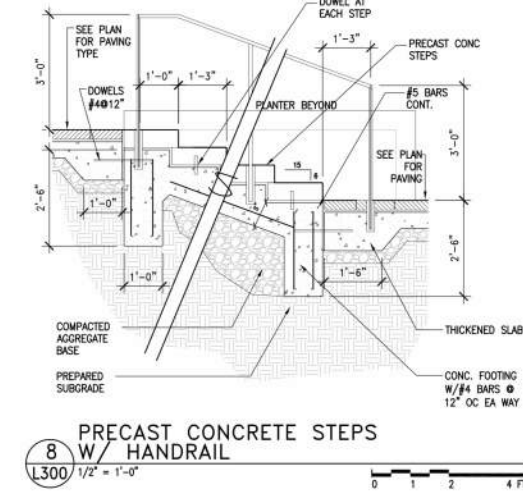
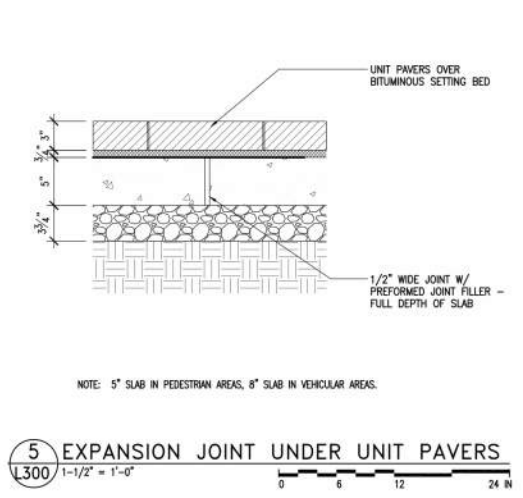
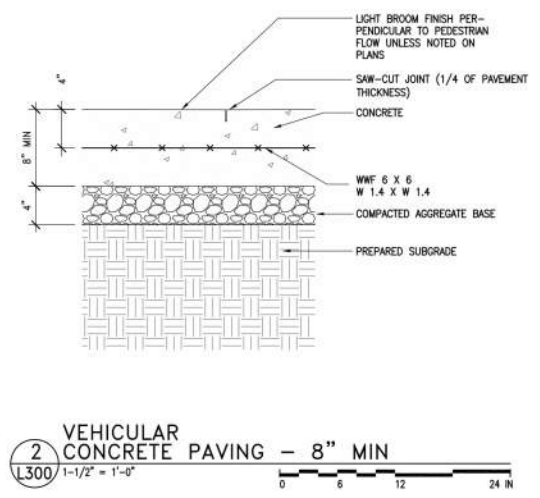
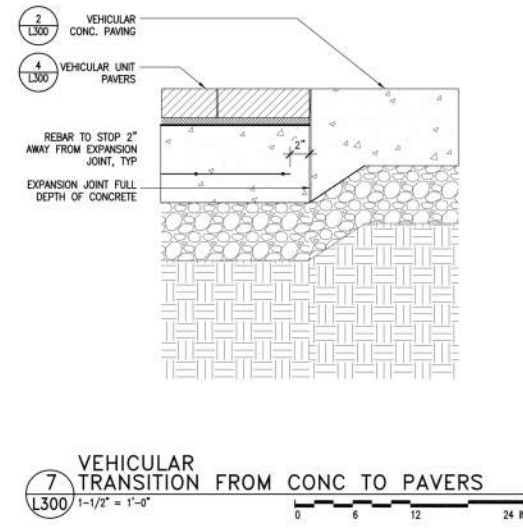
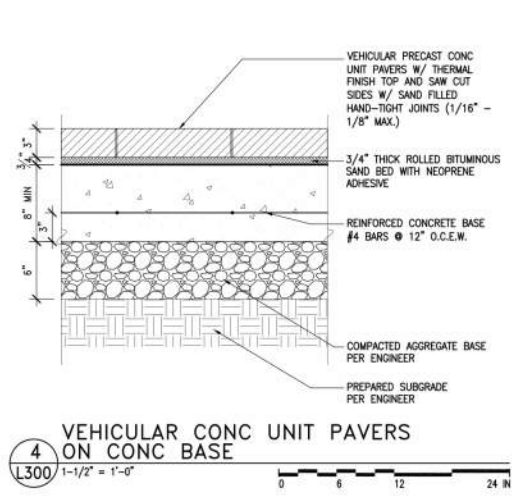
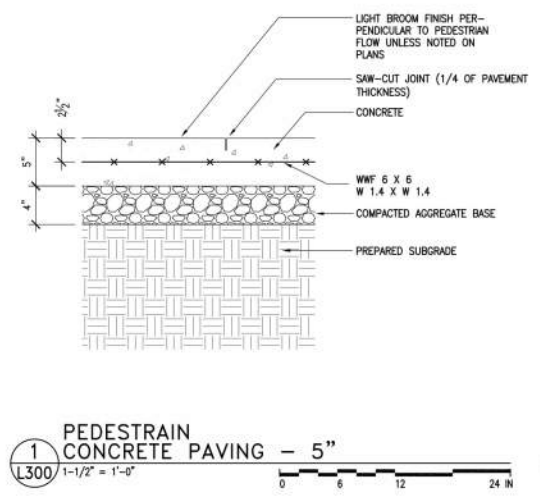

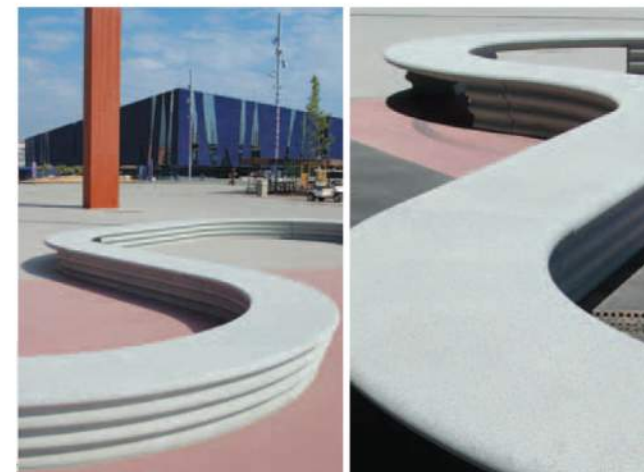
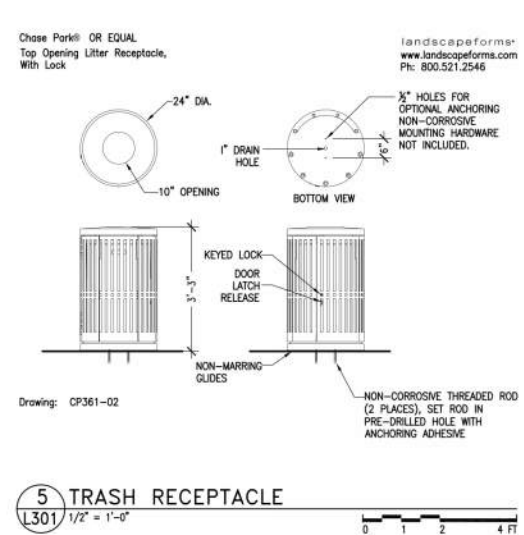
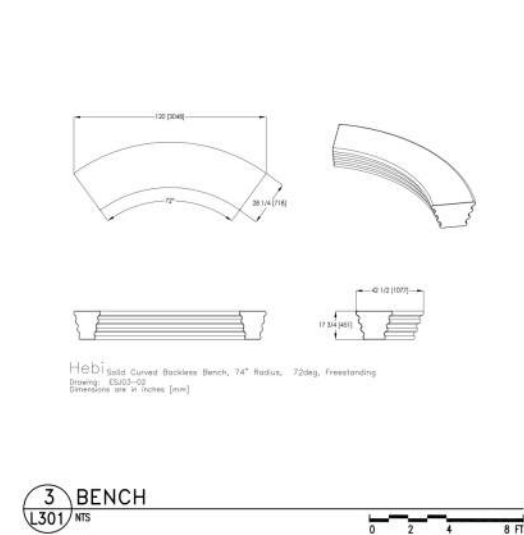
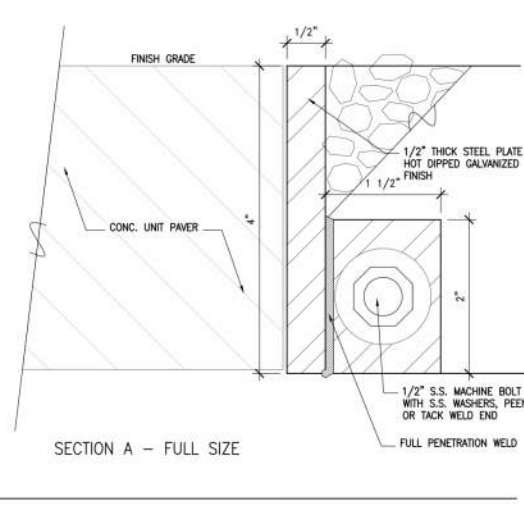
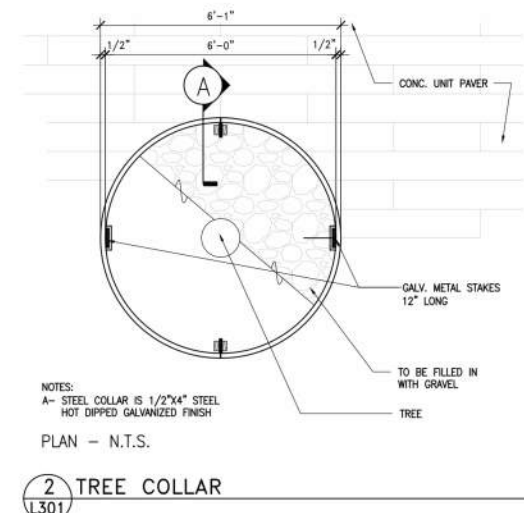
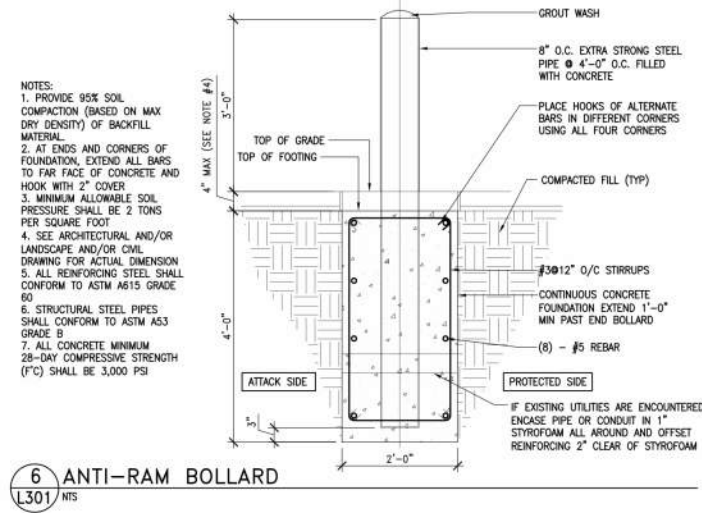
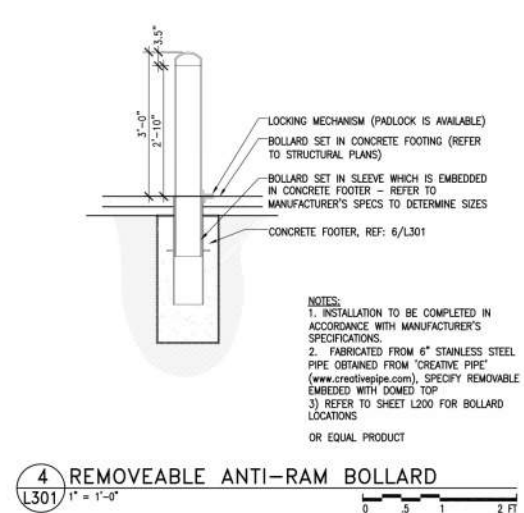
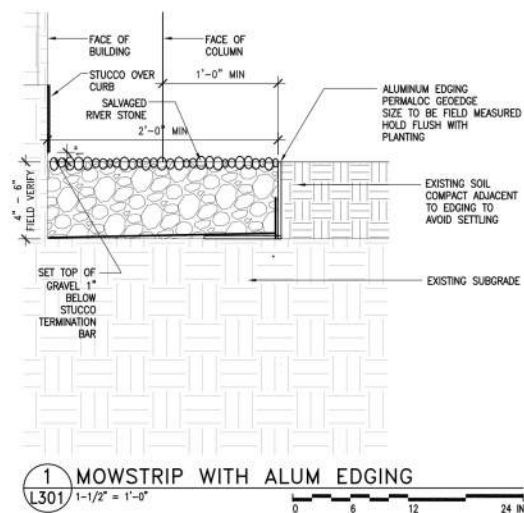

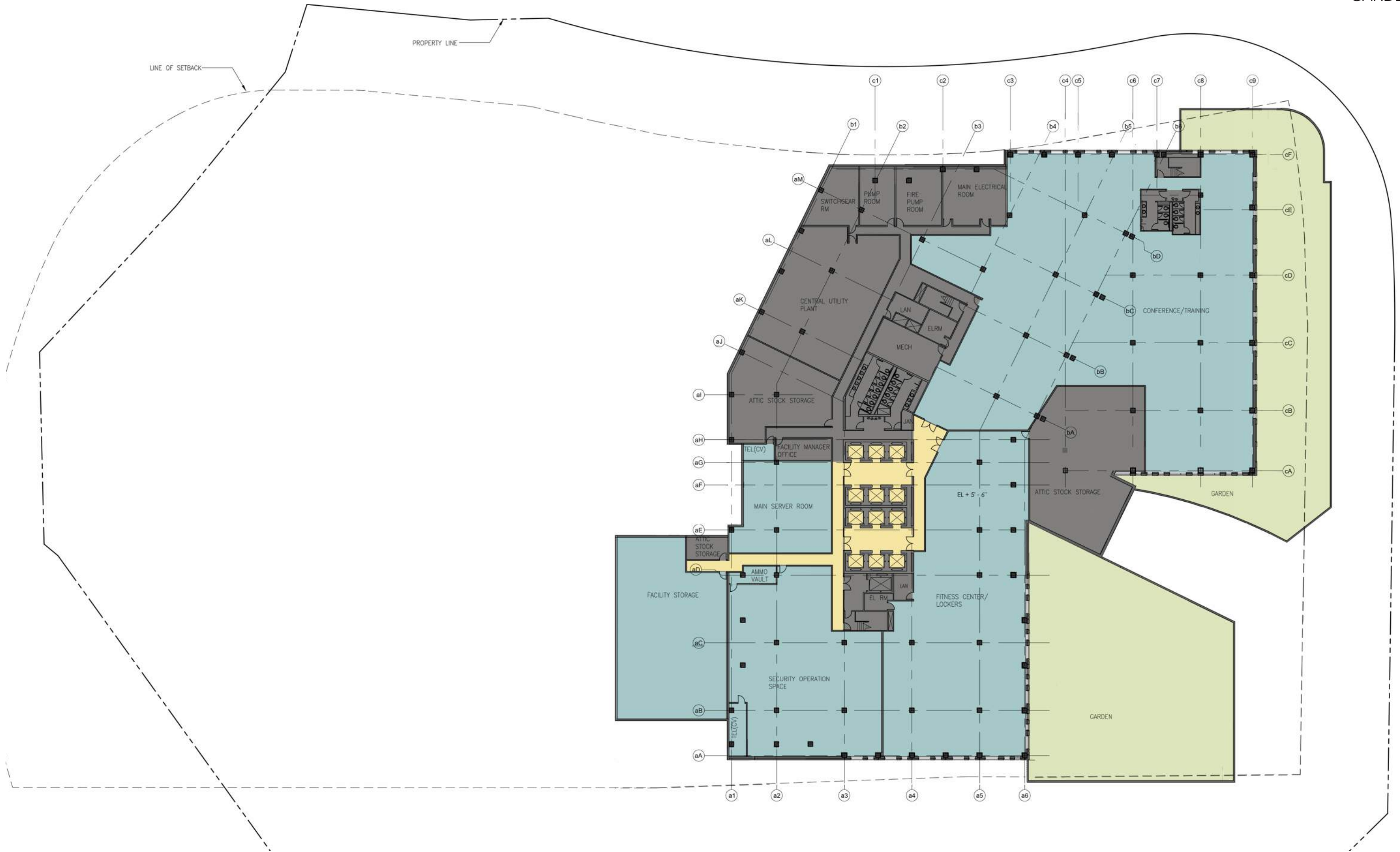

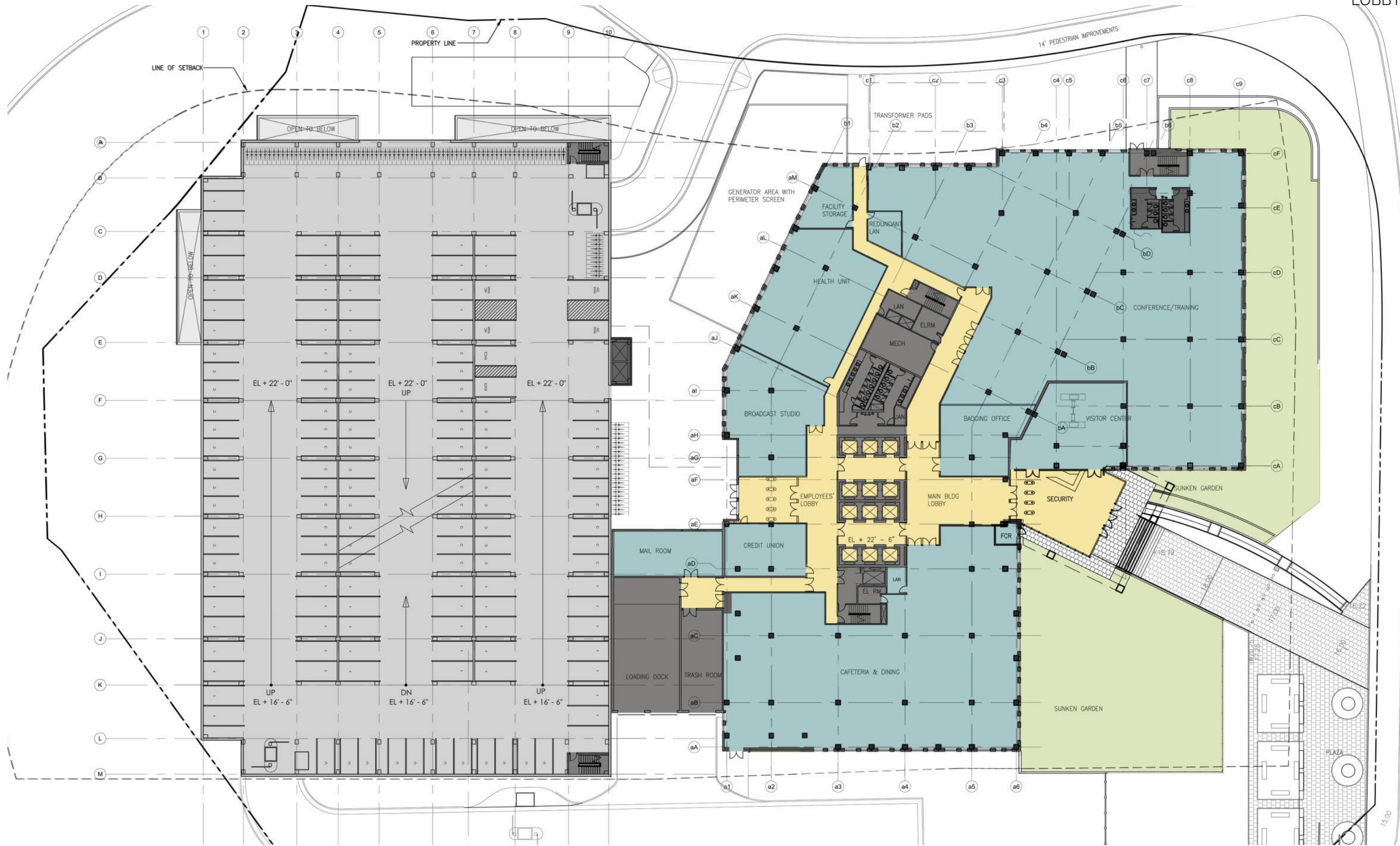



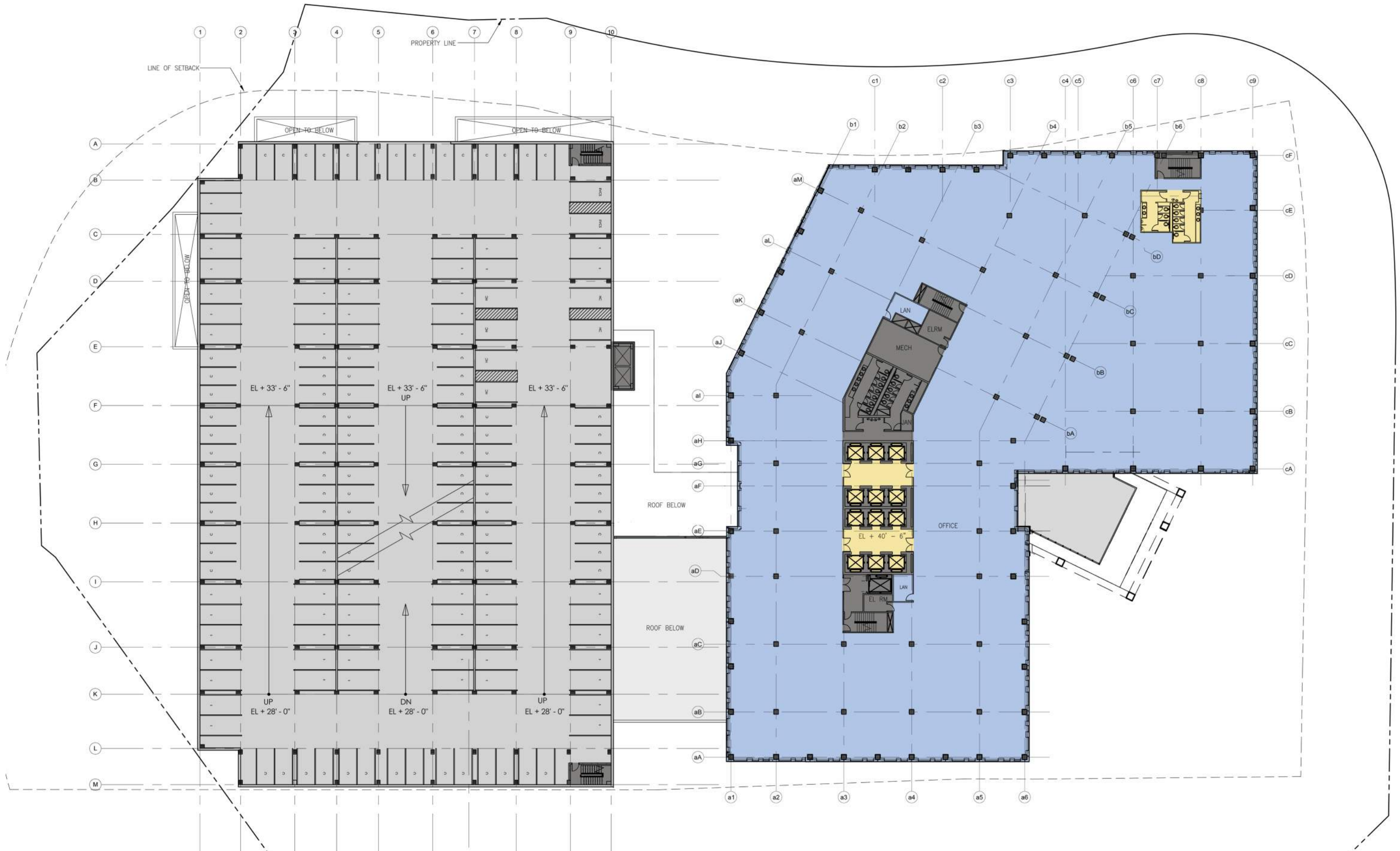

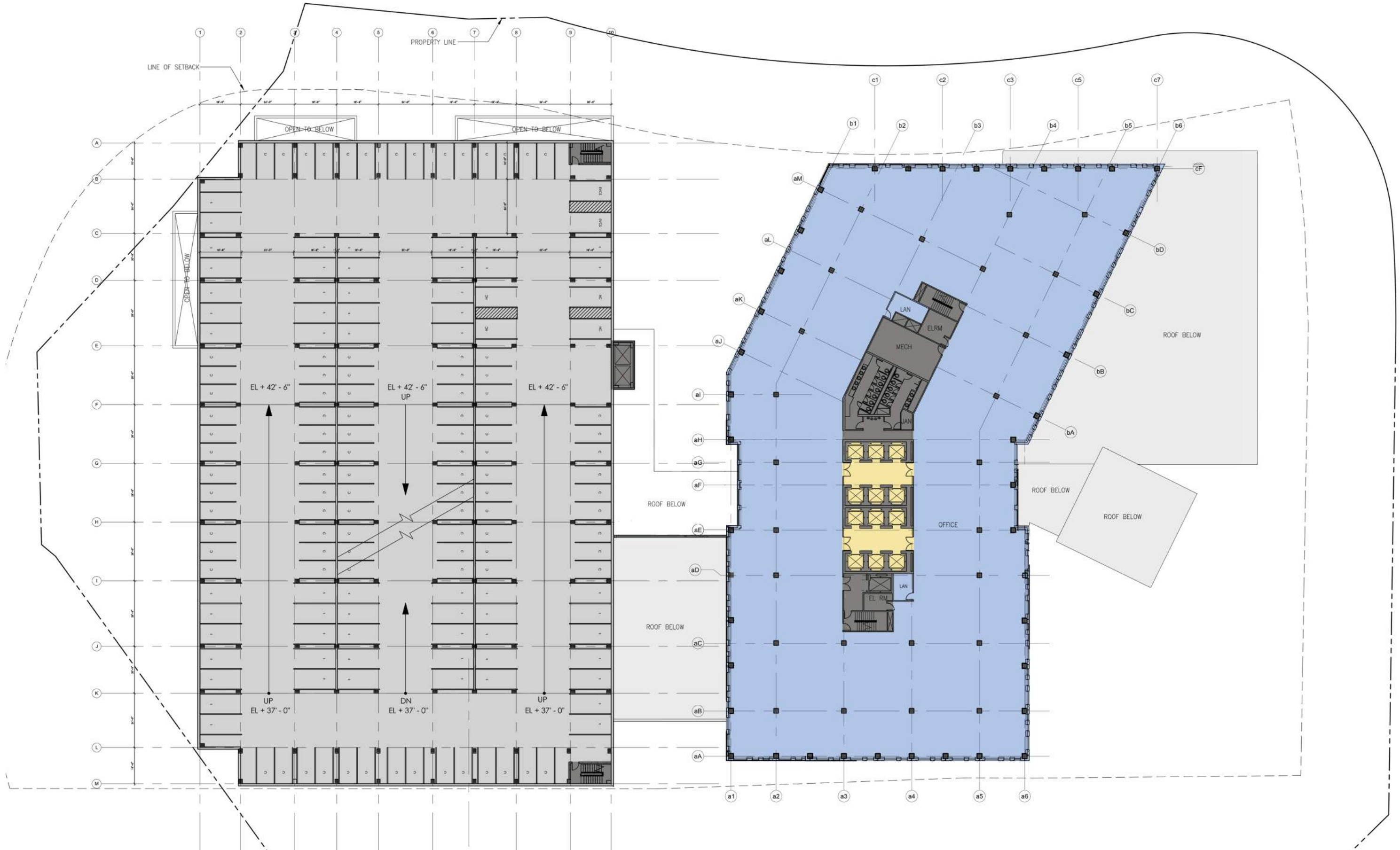

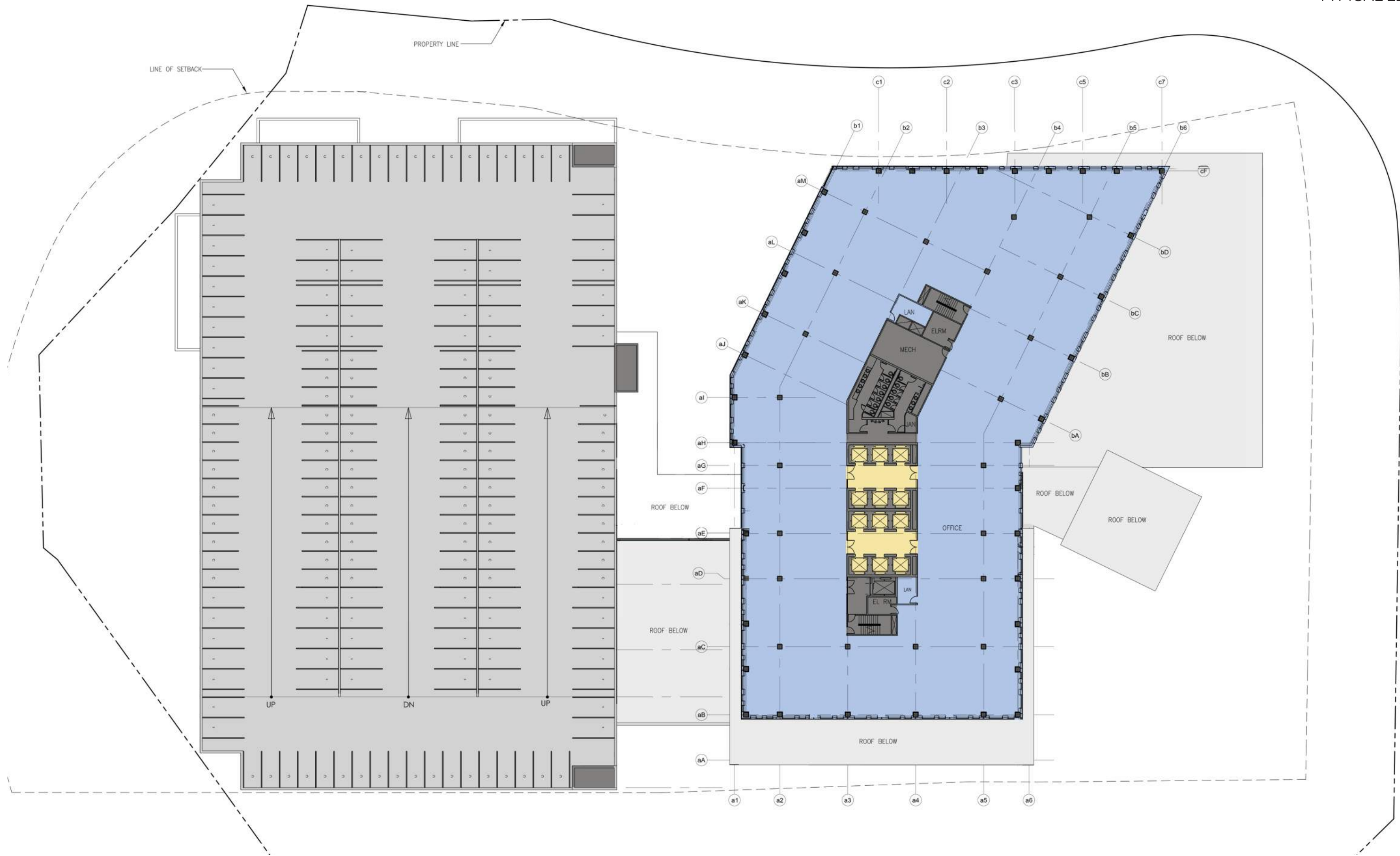

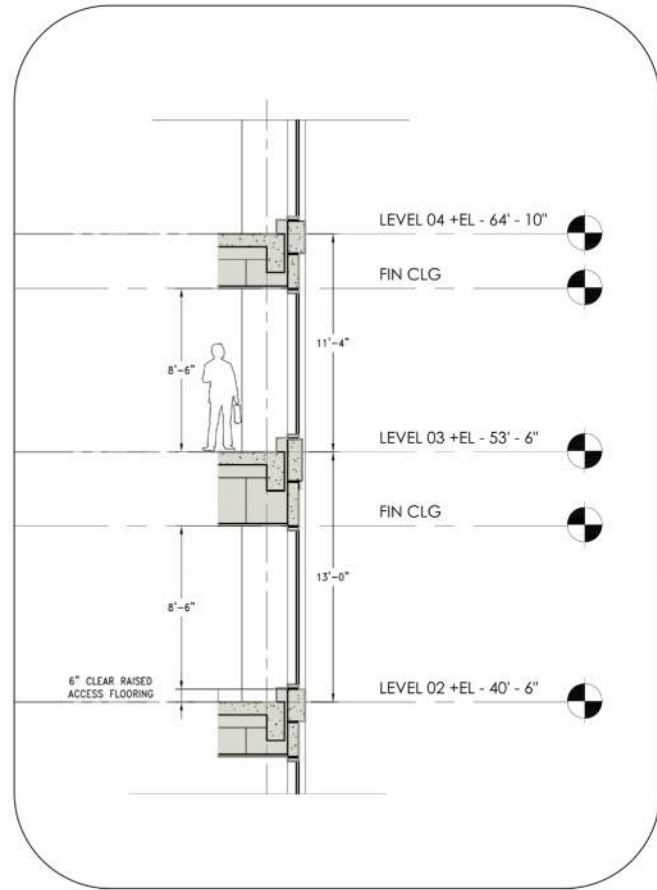

ENLARGED SECTION  
NTS.

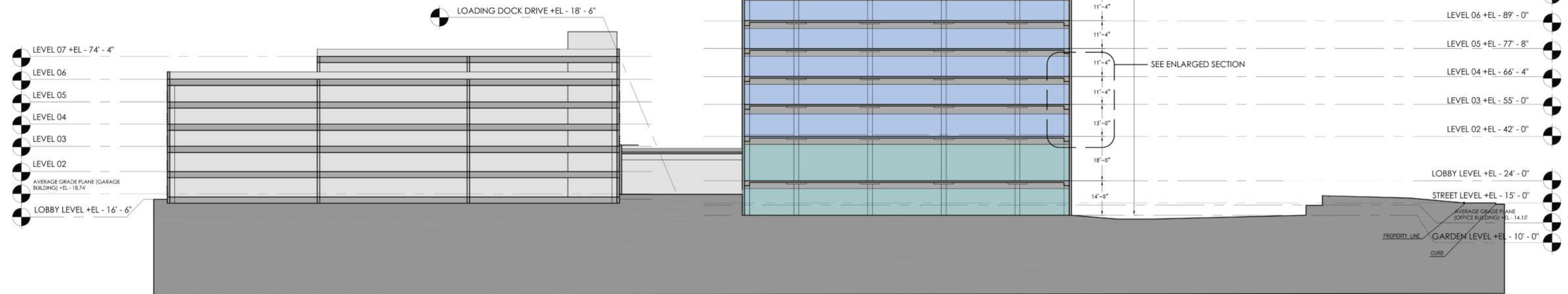







- ROOF +EL - 230' - 10"

---

- PENTHOUSE +EL - 212' - 10"

---

- LEVEL 16 +EL - 200' - 10"

---

- LEVEL 15 +EL - 189' - 6"

---

- LEVEL 14

---

- LEVEL 13

---

- LEVEL 12

---

- LEVEL 11

---

- LEVEL 10

---

- LEVEL 09

---

- LEVEL 08

---

- LEVEL 07

---

- LEVEL 06 +EL - 87' - 6"

---

- LEVEL 05 +EL - 76' - 2"

---

- LEVEL 04 +EL - 64' - 10"

---

- LEVEL 03 +EL - 53' - 6"

---

- LEVEL 02 +EL - 40' - 6"

---

- LOBBY LEVEL +EL - 22' - 6"





- ROOF +EL - 230' - 10"

---

- PENTHOUSE +EL - 212' - 10"

---

- LEVEL 16 +EL - 200' - 10"

---

- LEVEL 15 +EL - 189' - 6"

---

- LEVEL 14

---

- LEVEL 13

---

- LEVEL 12

---

- LEVEL 11

---

- LEVEL 10

---

- LEVEL 09

---

- LEVEL 08

---

- LEVEL 07

---

- LEVEL 06 +EL - 87' - 6"

---

- LEVEL 05 +EL - 76' - 2"

---

- LEVEL 04 +EL - 64' - 10"

---

- LEVEL 03 +EL - 53' - 6"

---

- LEVEL 02 +EL - 40' - 6"

---

- LOBBY LEVEL +EL - 22' - 6"



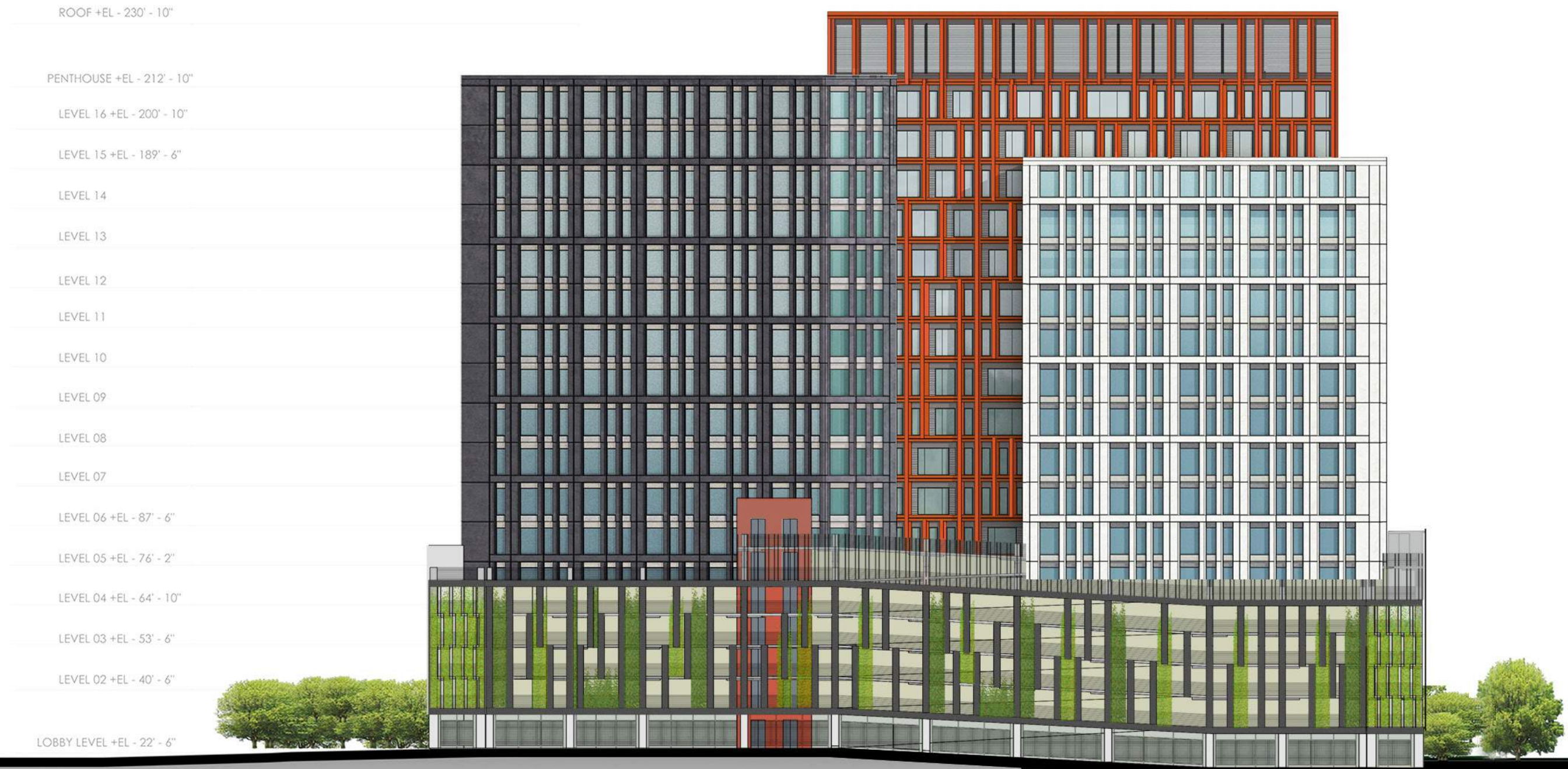





NORTH ELEVATION



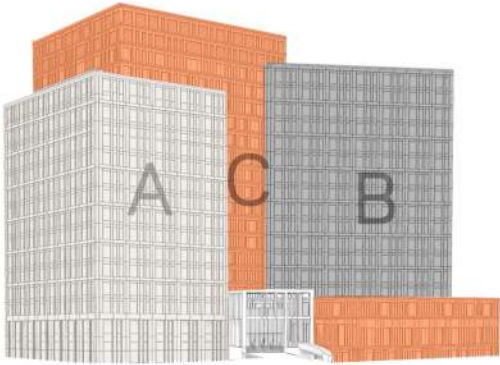



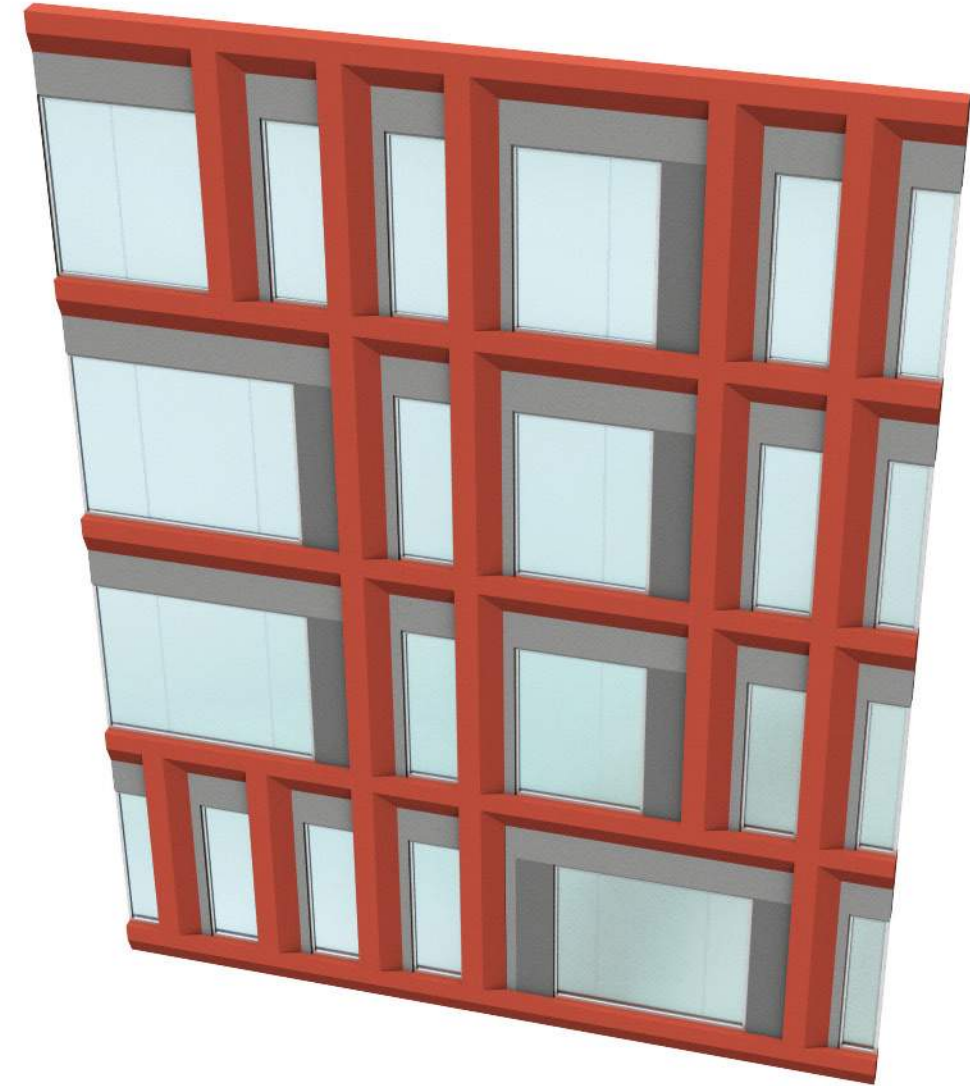
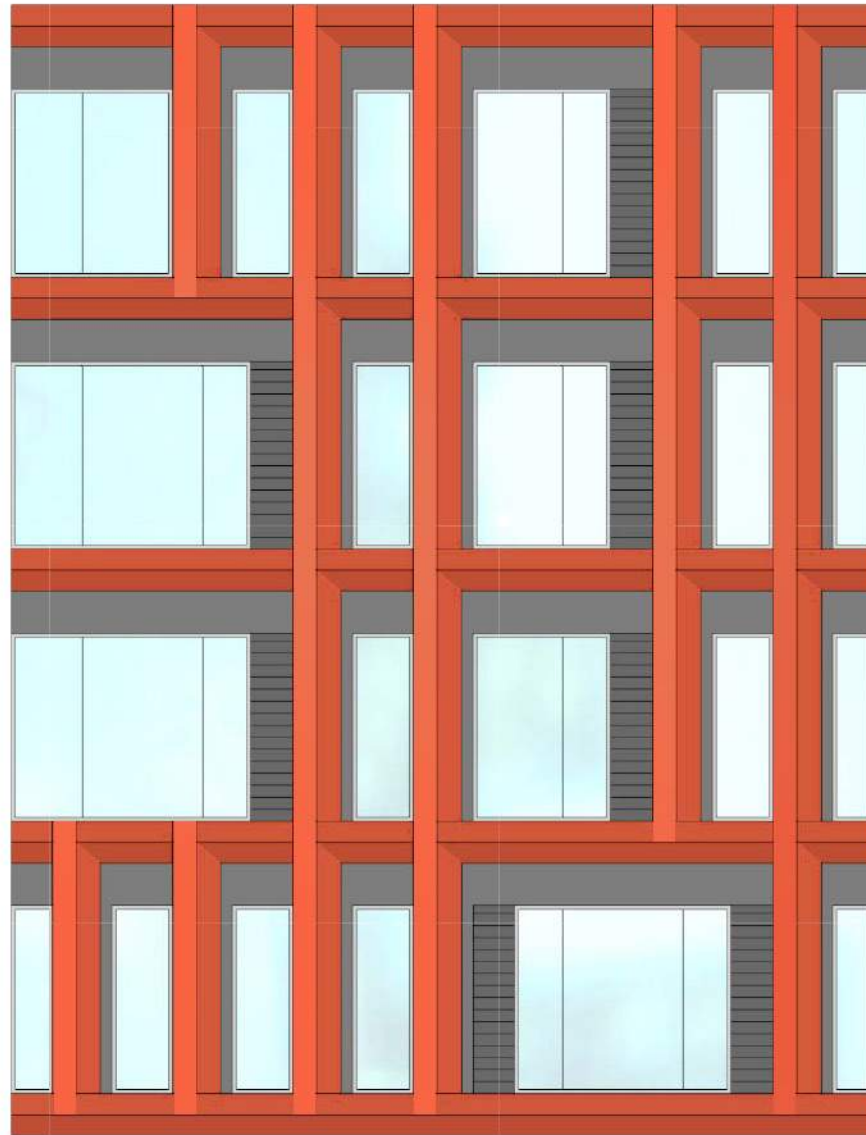
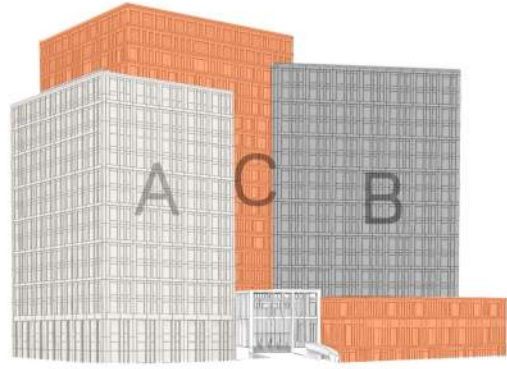

SKIN C